



GOCE High Level Processing Facility

GOCE Level 2 Product Data Handbook

Doc. No.: GO-MA-HPF-GS-0110
Issue: 5
Revision: 0
Date: 04 / 08 / 2014



Prepared by: The European GOCE Gravity Consortium
EGG-C

		<i>GOCE Level 2 Product Data Handbook</i> Doc. Nr: GO-MA-HPF-GS-0110 Issue: 5.0 Date: 04.08.2014 Page: 2 of 84
---	---	--

Document Information Sheet

Document Name
GOCE Level2 Product Data Handbook

Document ID	Issue	Date
GO-MA-HPF-GS-0110	5.0	04/08/2014

Author	Institute
Th. Gruber, R. Rummel O. Abrikosov R. van Hees	IAPG GFZ SRON
Contributions from	Institute
EGG-C partners	

Document Category	Document Class	Document Level
3	R	3

Configuration Item	Confidentiality Level
CI001	None

Appropriate Signatures		
Name	signature	Signature for approval
N.A.	N.A.	N.A.

Distribution List	
Person	Institute
R. Floberghagen, B. Frommknecht, F. De la Feld,	ESA
R. Rummel, Th. Gruber	IAPG
EGG-c partners	

List	
DIL	YES
CDL	NO
CIDL	NO
CSL	NO
CCN	NO
SWPRL	NO

Data Package	
SRR	NO
ADIR	NO
CDR	YES
AR0	NO
AR 1	YES
AR 2	YES
BP-CDR	YES
AR 3	YES
AR3.1	YES
AR3.2	YES



Document Change Record

ISSUE /REV.	CLASS (R=Review /A=Approval)	DATE	REASON FOR CHANGE	CHANGED PAGES / PARAGRAPHS
1.0	R	23/06/2004	Initial Issue for CDR	All
2.0	A	11/11/2005	Update for AR1 taking CDR RID's into account	Chapter 4: Editorial update. Chapter 4.4.1: LNOF description included. Chapter 5.2: SST_PSO_2 and EGG_NOM_2 temporal coverage changed to 1 day. RID-029: Chapter 4.1 updated. Chapters 5.3.1 to 5.3.3 updated.
2.1	A	18/01/2006	Update after AR1 and internal HPF document review.	AR-1 RID#18 – Items # in RID: <ol style="list-style-type: none"> 1. Issue numbers of applicable documents updated. 2. Figure 4.4 updated. 3. Chapter 4.4.1: Description for EFRF included. Chapter 5.2: Table for EGG_TRF_2 updated. 4. CTRS included in abbreviations list. 5. Chapter 4.4.2, page 22: Typo eliminated. 6. Chapter 4.4.2, equation 4-2 updated. 7. Chapter 5.2: Typo eliminated. 8. Chapter 5.2: Tables for EGG_NOM_2 and EGG_TRF_2 updated. 9. MPH and SPH included in abbreviations list. 10. no update required 11. Chapter 6: Typo eliminated. Internal Review: <ol style="list-style-type: none"> 1. List of abbreviations updated. 2. Chapter 1.1: Text updated. 3. Chapter 2.1: Applicable documents updated. 4. Chapter 4: Editorial update. 5. Chapter 4.1, Table 4-2: Description for calibration improved. 6. Chapter 4.1, page 18: Acronym description for IERS updated. 7. Chapter 4.3: Table 4-3: Geoid slopes replaced by deflections of the vertical. 8. Chapter 4.4.2: Quaternions description completely updated and interpolation formulas included. Explanation of terms in formulas improved. New reference paper. 9. Chapter 4.4.3: Definition of spherical harmonics improved. 10. Chapter 5.2: Specification for EGG_NOM_2 product updated.



3.0	A	22/09/2006	Issue for data exploitation AO	Chapter 4.3: Table 4-3 updated. Complete update of chapters 4.4.2 and 4.4.3. Complete update of chapter 5.3 and new chapter 5.4.
3.1	R	27/11/2006	Release after AR-2	RID#6: Table 1-1: Team member list updated. RID#12: Chapter 5.2: Table for product EGG_NOM_2 updated with description of external calibration technique. RID#25: Chapter 5.3.2.3 & 5.3.3.3: Explanation for tag 'Gregorian' included. Chapter 5.3.3: Data block format for SST_PSO_2 updated for missing velocities (AI'203).
3.2	R	26/02/2007	Release for Bridging Phase CDR	Chapter 2.1: List of applicable documents updated. Chapter 4.4.2.1, Equation 4-5: Value for Earth rotation rate adopted from GOCE standards.
3.3	R	08/05/2007	Update after Bridging Phase CDR	Document Information Sheet: Data Package mini table updated for BP milestones. BP-CDR-RID RF01: Chapter 2.1: HPF-BP SoW included as applicable document. Chapter 4.4.3.2: Equation (4-39) corrected. Chapter 5.3.3.3: Data block table for SST_PSO_2 updated (wrong sequence of tags removed)
4.0	R	09/06/2008	Update before launch.	List of abbreviations and acronyms updated. Chapter 1.3: Table 1-1 updated. Chapter 2.1: List of applicable documents updated. Chapter 4.1: Editorial update of GOCE mission description. Chapter 4.2: Data processing overview updated. Chapter 4.3: L2 products summary updated. Chapter 4.4: Editorial update of conventions. Chapter 4.4.2.2 newly included. Follow-up chapters renumbered. Chapter 5.2: Product descriptions updated. Chapter 5.3: XML declaration for HPF L2 products updated. Chapter 5.4: Format description of GVC product updated.
4.1	R	30/04/2009	Corrected Update after launch	Chapter 2.1: List of applicable documents updated. Chapter 4.4.3: Correction of formulas 4.23, 4.24. Chapter 4.4.3.1: Correction of formulas 4.39, 4.40, 4.41, 4.42, 4.51, 4.52, 4.53, 4.54, 4.55 and 4.56. Chapter 5.2.1: Description of EGG_NOM_2 product updated. Chapter 5.2.2: Description of product



				<p>EGG_TRF_2 updated.</p> <p>Chapter 5.2.4: Reference ellipsoid for GOCE gravity field product changed to GRS80.</p> <p>Chapter 5.3: First sentence corrected.</p> <p>Chapter 5.3.2: Table of XML Main Product Header (MPH) updated.</p> <p>Chapter 6: references updated.</p>
4.2	R	23/06/2010	Update for MOP-1	<p>Chapter 1.3, Table 1-1 updated.</p> <p>Chapter 4.4.1: Figure 4-4 replaced. z- and y-axes exchanged due to launch configuration.</p> <p>Chapter 4.4.2.2: Equations 4-15 corrected (Φ_{at} instead of Φ_t).</p> <p>Chapter 4.4.2.2.: Real part of quaternions q_0 replaced by q_4 in order to be consistent with format description and other documents.</p>
4.3	R	09/12/2010	Regular Update	<p>Chapter 5.2.1: Description for product EGG_NOM_2 updated.</p> <p>Chapter 5.3.3.2: Data block description for EGG_TRF updated.</p>
5.0	R	04/08/2014	Final Update	<p>Chapter 4.3, table 4-3 updated with new grid products.</p> <p>Chapter 4.4.3.2, equation 4.52 and 4.53: Sign error for derivative in y direction because y is defined as positive towards the West.;</p> <p>Chapter 4.4.3.2 after equation 4-52: Correction due to assumption of wrong coordinate system inserted.</p> <p>New chapters 5.2.3 and 5.2.4 for GRD_SPW_2_ and GRC_SPW_2_ products inserted (all follow-on chapters renumbered accordingly).</p> <p>New chapter 5.5 with format description of GRD_SPW_2_ and GRC_SPW_2_ products</p>



Abbreviations and Acronyms

AD	Applicable Document	GRS80	Geodetic Reference System 1980
ADIR	Architectural Design and Interface Review	GS	Ground Segment
AO	Announcement of Opportunity	HPF	High level Processing Facility
AR	Acceptance Review	ICD	Interface Control Document
ARF	Accelerometer Reference Frame	IERS	International Earth Rotation and Reference Systems Service
CCN	Contract Change Notice	IGS	International GNSS Service
CDAF	Command and Data Acquisition Facility	ILRS	International Laser Ranging Service
CDR	Critical Design Review	IRF	Inertial Reference Frame
CFI	Customer Furnished Item	LEOP	Launch and Early Orbit Phase
CMF	Calibration and Monitoring Facility	LORF	Local Orbital Reference Frame
CPF	Central Processing Facility	LRR	Laser Retro-Reflector
CTRS	Conventional Terrestrial Reference System	LTA	Long-Term Archive
DFACS	Drag-Free and Attitude Control System	MBW	Measurement BandWidth
DPA	Data Processing Archive	MPH	Main Product Header
ECMWF	European Centre for Medium-range Weather Forecast	PDS	Payload Data Segment
ECP	External Calibration Products	POD	Precise Orbit Determination
ECSS	European Cooperation for Space Standardization	PSO	Precise Science Orbit
EFRF	Earth Fixed Reference Frame	QL	Quick-Look
EGG	Electrostatic Gravity Gradiometer	RD	Reference Document
EGG-C	European GOCE Gravity Consortium	RERF	Radial Earth-pointing Reference Frame
EOQ	Earth Orientation Quaternions	RMS	Root-Mean Square
ESA	European Space Agency	SF	Scale Factor
FOS	Flight Operations Segment	SGG	Satellite Gravity Gradiometer
GG	Gravity Gradients	SLR	Satellite Laser Ranging
GOCE	Gravity field and steady-state Ocean Circulation Explorer	SOW	Statement Of Work
GPS	Global Positioning System	SPH	Specific Product Header
GRACE	Gravity Recovery And Climate Experiment	SRD	System Requirements Document
GRF	Gradiometer Reference Frame	SST	Satellite-to-Satellite Tracking
		SSTI	Satellite-to-Satellite Tracking Instrument
		UTC	Universal Time Coordinated
		WGS84	World Geodetic System 1984
		WP	Work Package
		XML	eXtensible Markup Language

Table of Contents

1. INTRODUCTION	9
1.1 PURPOSE.....	9
1.2 APPLICABILITY	9
1.3 DEFINITIONS.....	9
2. APPLICABLE AND REFERENCE DOCUMENTS	11
2.1 APPLICABLE DOCUMENTS.....	11
2.2 REFERENCE DOCUMENTS	11
3. GOCE GROUND SEGMENT	13
3.1 OVERVIEW GOCE GROUND SEGMENT.....	13
3.2 HIGH-LEVEL PROCESSING FACILITY.....	13
4. MISSION AND PRODUCTS OVERVIEW	14
4.1 THE GOCE MISSION	14
4.2 GOCE DATA PROCESSING OVERVIEW.....	18
4.3 GOCE LEVEL 2 PRODUCTS SUMMARY	19
4.4 GENERAL DEFINITIONS AND CONVENTIONS.....	21
4.4.1 REFERENCE FRAMES AND TIME SYSTEM	21
4.4.2 MATHEMATICAL CONVENTIONS	24
4.4.2.1 EARTH ORIENTATION QUATERNIONS.....	24
4.4.2.2 INTERPOLATION OF QUATERNIONS	26
4.4.2.3 SPHERICAL HARMONIC SERIES	27
4.4.2.4 ERROR PROPAGATION	28
4.4.3 GRAVITY FIELD CONVENTIONS	28
4.4.3.1 APPROXIMATIONS FOR DERIVED QUANTITIES	31
4.4.3.2 MORE ACCURATE FORMULATIONS FOR DERIVED QUANTITIES.....	35
5. LEVEL-2 PRODUCT DEFINITIONS.....	42
5.1 PRODUCT IDENTIFIER.....	42
5.2 PRODUCT DESCRIPTIONS.....	43
5.2.1 EGG_NOM_2_	43
5.2.2 EGG_TRF_2_	48
5.2.3 GRD_SPW_2_	50
5.2.4 GRC_SPW_2_.....	52
5.2.5 SST_PSO_2_.....	54
5.2.6 EGM_GOC_2_	56
5.2.7 EGM_GVC_2_.....	58
5.2.8 SST_AUX_2_.....	59
5.3 XML PRODUCT FORMATS.....	61
5.3.1 FILE STRUCTURE	61
5.3.2 XML HEADER FILE.....	61
5.3.2.1 SPH PRODUCT SPECIFIC TAGS: EGG_NOM_2_.....	63
5.3.2.2 SPH PRODUCT SPECIFIC TAGS: EGG_TRF_2_	64
5.3.2.3 SPH PRODUCT SPECIFIC TAGS: SST_PSO_2_.....	64
5.3.2.4 SPH PRODUCT SPECIFIC TAGS: EGM_GOC_2_	67
5.3.2.5 SPH PRODUCT SPECIFIC TAGS: SST_AUX_2_.....	70
5.3.3 XML DATA BLOCK FILE	70
5.3.3.1 EGG_NOM_2_.....	70
5.3.3.2 EGG_TRF_2_	72
5.3.3.3 SST_PSO_2_.....	73
5.3.3.4 EGM_GOC_2_	74
5.3.3.5 SST_AUX_2_	75

		<p><i>GOCE Level 2 Product Data Handbook</i> Doc. Nr: GO-MA-HPF-GS-0110 Issue: 5.0 Date: 04.08.2014 Page: 8 of 84</p>
--	---	---

5.4 EGM_GVC_2_FORMAT 77

5.5 GRD/GRC_SPW_2_FORMAT 82

6. REFERENCES 84

7. ACKNOWLEDGEMENT..... 84

		<p><i>GOCE Level 2 Product Data Handbook</i></p> <p>Doc. Nr: GO-MA-HPF-GS-0110</p> <p>Issue: 5.0</p> <p>Date: 04.08.2014</p> <p>Page: 9 of 84</p>
---	---	---

1. INTRODUCTION

1.1 PURPOSE

The purpose of this document is to provide a detailed description of the GOCE level 2 products generated by the High Level Processing Facility and distributed to the GOCE users. These products include GOCE gravity gradients, GOCE orbit solutions as well as the GOCE gravity field models including supporting information. The document describes everything required to make use of the level 2 products for further processing or application.

1.2 APPLICABILITY

This document is part of the Deliverable Items List [AD-3]. The first issue is delivered at CDR and classifies for review by the Agency. An update of the document shall be delivered at AR-1 and AR-2 for approval by the Agency. The document applies to the development phase and to the actual implementation and operational phases of the HPF.

1.3 DEFINITIONS

The term “Contract” is used to indicate the HPF implementation contract.
The term “the Contractor” is used to indicate the entity in charge of implementing the HPF.
The term “Agency” is used to indicate the European Space Agency (ESA).

EGG-C is composed by 10 European institutions. Institutions and team members contributing to the HPF project are defined in Table 1-1.

		<p><i>GOCE Level 2 Product Data Handbook</i> Doc. Nr: GO-MA-HPF-GS-0110 Issue: 5.0 Date: 04.08.2014 Page: 10 of 84</p>
---	---	--

Table 1-1: EGG-C Team Members in Alphabetical Order

Acronym	Institution	Function	Team Members
AIUB	Astronomical Institute, University of Bern, Switzerland	WP4000 Partner	G. Beutler H. Bock
CNES	Centre National d'Etudes Spatiales, Groupe de Recherche de Géodésie Spatiale, Toulouse, France	WP5000 Manager	G. Balmino S. Bruinsma
FAE/A&S	Faculty of Aerospace Engineering, Astrodynamics & Satellite systems, Delft University of Technology, Delft, The Netherlands	WP 4000 Manager WP 3000 Partner WP 8000 Partner WP 6000 Consultant	P. Visser
GFZ	GeoForschungsZentrum Potsdam, Department 1 Geodesy and Remote Sensing, Potsdam, Germany	WP 5000 Partner	Ch. Förste
IAPG	Institute of Astronomical and Physical Geodesy, Technical University Munich, Germany	Principal Investigator Management WP 3000 Manager WP 4000 Partner WP 6000 Partner WP 8000 Manager	R. Rummel Th. Gruber U. Hugentobler J. Bouman
ITG	Institute of Theoretical Geodesy, University Bonn, Germany	WP 6000 Partner	W.D. Schuh
POLIMI	DIIAR – Sezione Rilevamento, Politecnico di Milano, Italy	WP 7000 Manager	F. Sanso F. Migliaccio
SRON	SRON National Institute for Space Research, Utrecht, The Netherlands	Management WP3000 Partner	R. van Hees S. Rispens
TUG	Institute of Navigation and Satellite Geodesy, Graz University of Technology	WP 6000 Manager	H. Sünnkel R. Pail E. Höck
UCPH	Department of Geophysics, University of Copenhagen, Denmark	WP 3000 Partner WP 7000 Partner	Ch. Tscherning

2. APPLICABLE AND REFERENCE DOCUMENTS

2.1 APPLICABLE DOCUMENTS

- [AD-1] GO-SW-ESA-GS-0079: GOCE High Level Processing Facility, Statement of Work, Issue 2.0, 4. May 2004
- [AD-2] GO-RS-ESA-GS-0080: GOCE High Level Processing Facility, Statement of Work Appendix 1, Management Requirements, Issue 2.0, 4. May 2004
- [AD-3] GO-LI-ESA-GS-0081: GOCE High Level Processing Facility, Statement of Work Appendix 2, Deliverable Items List, Issue 2.0, 4. May 2004
- [AD-4] GO-RS-ESA-GS-0082: GOCE High Level Processing Facility, Statement of Work Appendix 3, Technical Requirements Specification, Issue 2.0, 4. May 2004
- [AD-5] GO-LI-ESA-GS-0087: GOCE High Level Processing Facility, Statement of Work Appendix 4, List of CFI, Issue 1.0, 5. December 2003
- [AD-6] GO-TN-ESA-GS-0085: GOCE High Level Processing Facility, Statement of Work Appendix 5, Tailoring of ECSS Standards, Issue 1.0, 5. December 2003
- [AD-7] ECSS-E-40B: Space Engineering, Software Standards, Draft Issue, 28. July 2000
- [AD-8] ECSS-Q-80B: Space Product Assurance, Software Product Assurance, Issue 3. April 2000
- [AD-9] PE-TN-ESA-GS-0001: Earth Explorer Ground Segment File Format Standard, Issue 1.4, 13.6.2003
- [AD-10] GO-ID-ACS-GS-0109: L1B Product Specification Document, Issue 3.3, 30.7.2007
- [AD-11] GO-ID-HPF-GS-0041: Product Specification for L2 Products and Auxiliary Data Products, Issue 6.1, 30. April 2009
- [AD-12] GO-TN-HPF-GS-0111: GOCE Standards, Issue 3.1, 30. April 2009
- [AD-13] GO-RS-ESA-GS-0158: HPF Bridging Phase (HPF-BP) Statement of Work, Issue 1.0, 2.10.2006
- [AD-14] GO-SW-ESA-GS-0194: HPF Bridging Phase 2 (HPF-BP2) Statement of Work, Issue 1.0, 30.10.2007
- [AD-15] GO-SW-ESA-GS-0251: HPF Bridging Phase 3 (HPF-BP3) Statement of Work, Issue 1.0, 5.12.2008

2.2 REFERENCE DOCUMENTS

- [RD-1] ESA-SP-1233(1): Gravity Field and Steady-State Ocean Circulation Mission
 - [RD-2] GO-RS-ESA-SY-0001: GOCE Mission requirements Document
 - [RD-3] GO-TN-ESA-GS-0017: GOCE Ground Segment Concept and Architecture
 - [RD-4] GO-SP-AI-0004: GPS Receiver Ground Processing Algorithms Specification
 - [RD-5] GO-SP-AI-0003: Gradiometer Ground Processing Algorithms Specification
 - [RD-6] GO-TN-AI-0067: Gradiometer Ground Processing Algorithms Documentation
 - [RD-7] GO-TN-AI-0068: Gradiometer Ground processing Analysis
 - [RD-8] GO-PL-AI-0039: Gradiometer Calibration Plan
 - [RD-9] GO-TN-AI-0069: Gradiometer On-Orbit Calibration Procedure Analysis
 - [RD-10] GO-RP-AI-0014: Mission Analysis Report
-

		<p><i>GOCE Level 2 Product Data Handbook</i></p> <p>Doc. Nr: GO-MA-HPF-GS-0110 Issue: 5.0 Date: 04.08.2014 Page: 12 of 84</p>
---	---	--

- [RD-11] CS-MA-DMS-GS-0001: Earth Explorer Mission Conventions Document
- [RD-12] GO-MA-AI-0002: GOCE User's Manual
- [RD-13] GO-TN-AI-0027: Performance Requirements and Budgets for the Gradiometric Mission
- [RD-14] GO-TN-IAPG-0001: Detailed Processing Model for EGG
- [RD-15] GO-TN-IAPG-0002: Detailed Processing Model for SSTI
- [RD-16] GO-ID-ESC-FS-5070: FOS/PDS – PDS/SLR: Predicted Orbit File
- [RD-17] GO-RS-ESA-GS-0052: Product Requirement Document
- [RD-18] ECSS-M-00A: Policy Principles
- [RD-19] ECSS-M-10A: Project Breakdown and Structures
- [RD-20] ECSS-M-20A: Project Organization
- [RD-21] ECSS-M-30A: Project Phasing and Planning
- [RD-22] ECSS-M-40A: Configuration Management
- [RD-23] ECSS-M-50A: Information / Documentation Management
- [RD-24] ECSS-M-60A : Cost Schedule Management
- [RD-25] ECSS-M-70A: Integrated Logistics Support
- [RD-26] GO-MI-ESA-0101: Minutes of the HPF Negotiation Meeting
- [RD-27] GO-AI-HPF-GS-0008: Action Item Reply of HPF Negotiation Meeting
- [RD-28] GO-AI-HPF-GS-0013: Action Item Reply of HPF Negotiation Meeting
- [RD-29] GO-ID-ESC-FS-5070: FOS/FDS to PDS/SLR: Predicted Orbit File Interface Control Document
- [RD-30] DTOS-FDOS-FDIS-ICD-0250-TOS-GFM: Flight Dynamics Infrastructure Software Napeos Interface Control Document
- [RD-31] PE-TN-ESA-GS-0001: Earth Explorer Ground Segment File Format Standard
- [RD-32] GO-ID-ESA-GS-0037: GOCE Ground Segment Master ICD

As a general rule it holds that the latest approved issue of the document is applicable, except if the issue number and the document date is specified.



3. GOCE GROUND SEGMENT

3.1 OVERVIEW GOCE GROUND SEGMENT

The GOCE ground segment concept and architecture is described in [RD-3]. The following gives a brief summary of all ground segment elements, depicted in Figure 3-1.

Figure 3-1: GOCE Ground System

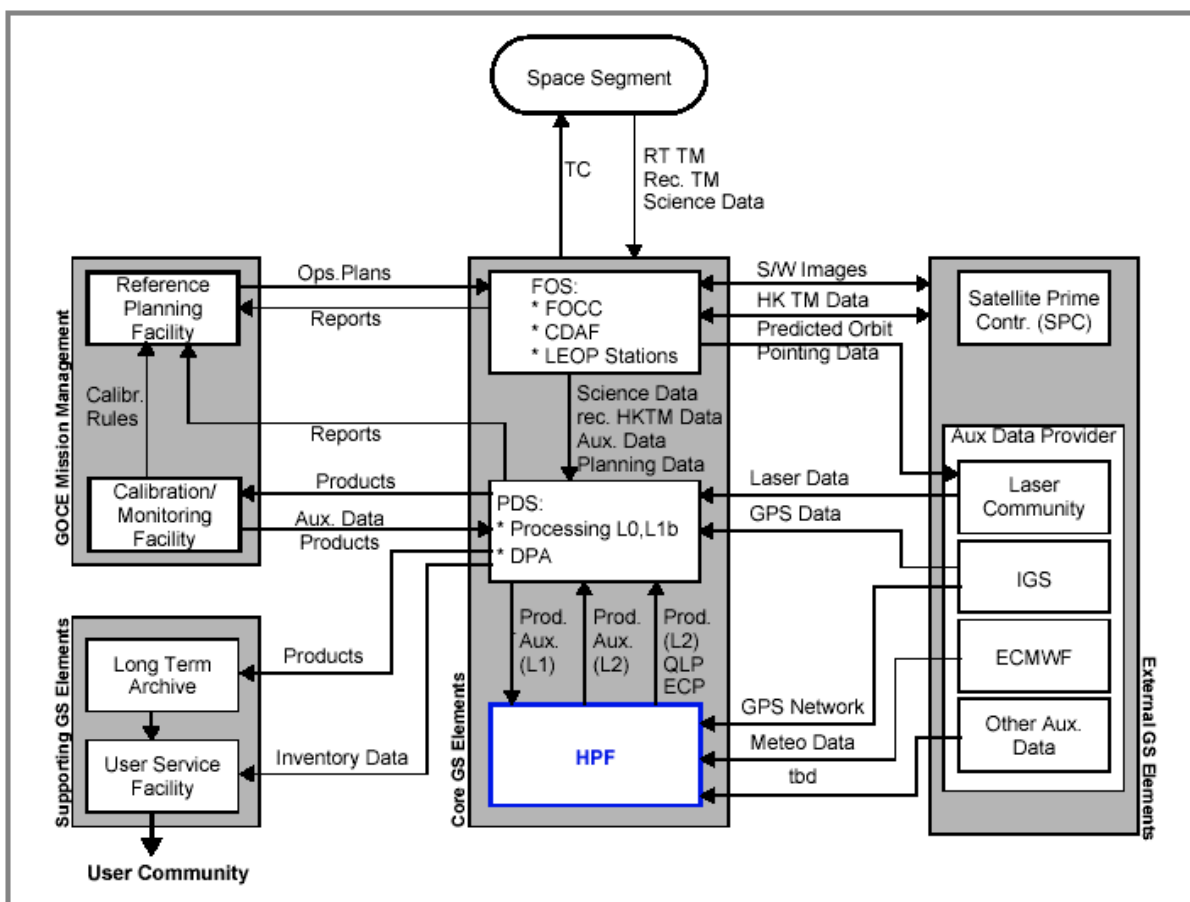

3.2 HIGH-LEVEL PROCESSING FACILITY

Within the GOCE GS the HPF is one of the Core GS Elements (ESA-controlled), and it is charged with the generation of L2 products and acquisition of the external (auxiliary) data needed to generate these products, the delivery of these products (auxiliary, intermediate and final) to the PDS/DPA and/or the LTA and the generation of Quick-Look Products and External Calibration Products for the purpose of the activities of the CMF.

		<p><i>GOCE Level 2 Product Data Handbook</i> Doc. Nr: GO-MA-HPF-GS-0110 Issue: 5.0 Date: 04.08.2014 Page: 14 of 84</p>
---	---	--

4. MISSION AND PRODUCTS OVERVIEW

4.1 THE GOCE MISSION

Mission Goals

GOCE is the acronym for „Gravity field and steady-state Ocean Circulation Explorer mission“. It is the first core satellite mission of the newly defined ESA “Living Planet” programme. The objective of GOCE is the determination of the stationary part of the Earth gravity field and geoid with highest possible spatial detail and accuracy. The gravity and geoid model derived from the GOCE mission will serve science and application in the fields of solid earth physics, oceanography, geodesy and glaciology, compare (Johannessen et al, 2003; Rummel et al, 2002).

Two main uses can be distinguished. Firstly, the spatial variations of gravity and geoid are directly related to density anomalies in lithosphere and upper mantle, respectively, and consequently to interior stresses and ultimately to mass motion. In this respect GOCE provides important new information to studies of continental and oceanic lithosphere and upper mantle. Its information is complementary to that of seismic tomography, magnetic field models, geokinematic studies and laboratory results. Secondly, a detailed geoid surface when combined with satellite altimetry yields sea surface topography, the quasi-stationary deviation of the ocean surface from its hypothetical surface of rest. Under the assumption of geostrophic balance ocean topography can be directly translated into a global map of surface ocean circulation. Thus, ocean surface circulation becomes directly measurable, globally and uninterruptedly. In conjunction with higher resolution ocean models and ocean measurements, GOCE is expected to improve significantly estimates of global mass and heat transport in the oceans. Furthermore, the global geoid will permit height systems to be connected globally with almost cm-precision. Sea level variations in Australia, or East Asia will become directly comparable with those measured in Europe or America. These and other expected scientific benefits from GOCE gravity and geoid models demonstrate that this mission represents an important element of global observation of mass anomalies, mass transport and mass exchange. The science goals and the requirements on the mission performance are summarized in Table 4-1.

The science goals as summarized in Table 4-1 can be reached on the condition that GOCE can determine gravity and geoid with a precision of 10^{-6} ·g (corresponding to 1 mgal) and 1-2 cm, respectively, with a spatial resolution of better of 100 km half wavelength and that these results are achieved free of long wavelength systematic errors. The mission performance depends on the gravity sensor system on-board GOCE.

Table 4-1: Science Goals of the GOCE Mission (ESA, 1999)

Application	Accuracy		Spatial Resolution (half wavelength – D in km)
	Geoid [cm]	Gravity [mgal]	
SOLID EARTH			
Lithosphere and upper mantle density structure		1-2	100
Continental lithosphere:			
▪ Sedimentary basins		1-2	50-100
▪ Rifts		1-2	20-100
▪ Tectonic motions		1-2	100-500
Seismic hazards		1	100
Ocean lithosphere and interaction with asthenosphere		0.5-1	100-200
OCEANOGRAPHY			
▪ Short scale	1-2		100
	0.2		200
▪ Basin scale	≈0.1		1000
ICE SHEETS			
▪ Rock basement		1-5	50-100
▪ Ice vertical movements	2		100-1000
GEODESY			
▪ Levelling by GPS	1		100-1000
▪ Unification of worldwide height systems	1		100-20000
▪ Inertial navigation system		1-5	100-1000
▪ Orbits		1-3	100-1000
SEA LEVEL CHANGE	Many of the above applications, with their specific requirements, are relevant to studies of sea-level change.		

GOCE Sensor System

The GOCE satellite and its instruments are shown in Figure 4-1. Core instrument is a three axis gravity gradiometer. It consists of three pairs of orthogonally mounted 3-axis accelerometers, i.e. an orthogonal arrangement of three one-axis gradiometers, with the x-axis nominally in the along track direction, the y-axis cross track and the z-axis roughly in the radial direction. The gradiometer baseline of each pair is about 50 cm. The accelerometer precision is $10^{-12} ms^{-2} / \sqrt{Hz}$ along two axes with the third axis less sensitive. From the measured gravitational acceleration differences the three main diagonal terms of the gravitational tensor (Γ_{xx} , Γ_{yy} , Γ_{zz}) as well as the off-diagonal term Γ_{xz} can be determined with high precision, whereas the off-diagonal terms Γ_{xy} and Γ_{yz} have a lower precision. The extremely high performance of the gradiometer instrument is confined to the so-called measurement bandwidth (MBW). In addition, the gradiometer yields the required information of the angular acceleration about the out-of-plane axis of the gradiometer. This information in combination with the angular rates as derived from the star sensor readings is used as control signal for angular control of the spacecraft. The satellite has to be guided well controlled and smoothly around the Earth in an Earth pointing mode, i.e. with one full revolution per orbit revolution. Angular control is attained via magneto-torquers. This implies that active angular motion is possible only over part of each orbit revolution. In order to prevent non-gravitational forces to “sneak” into the measured differential accelerations as secondary

effect, the satellite is kept “drag-free” in along track direction by means of a pair of ion thrusters. The necessary control signal is derived from the available “common-mode” accelerations (=mean accelerations) along the three orthogonal axes of the accelerometer pairs of the gradiometer. The gradiometric and angular signal part of the common mode acceleration is a result of the imperfect symmetry of the gradiometer relative to the spacecraft centre of mass and has to be modelled.

The second gravity sensor device is a newly developed GPS receiver. From its measurements the orbit trajectory is computed to within a few centimetres, either purely geometrically, a so-called kinematic orbit, or by the method of reduced dynamic orbit determination. As the spacecraft is kept in an almost drag-free mode (at least along track) the orbit motion is purely gravitational. The observations from the GPS receiver are complementary to those of the gravity gradiometer. They provide high quality information about the long wavelength gravity field, which is outside the measurement bandwidth of the gradiometer. By a joint analysis of data from both gravity field sensors the final GOCE gravity field models are determined.

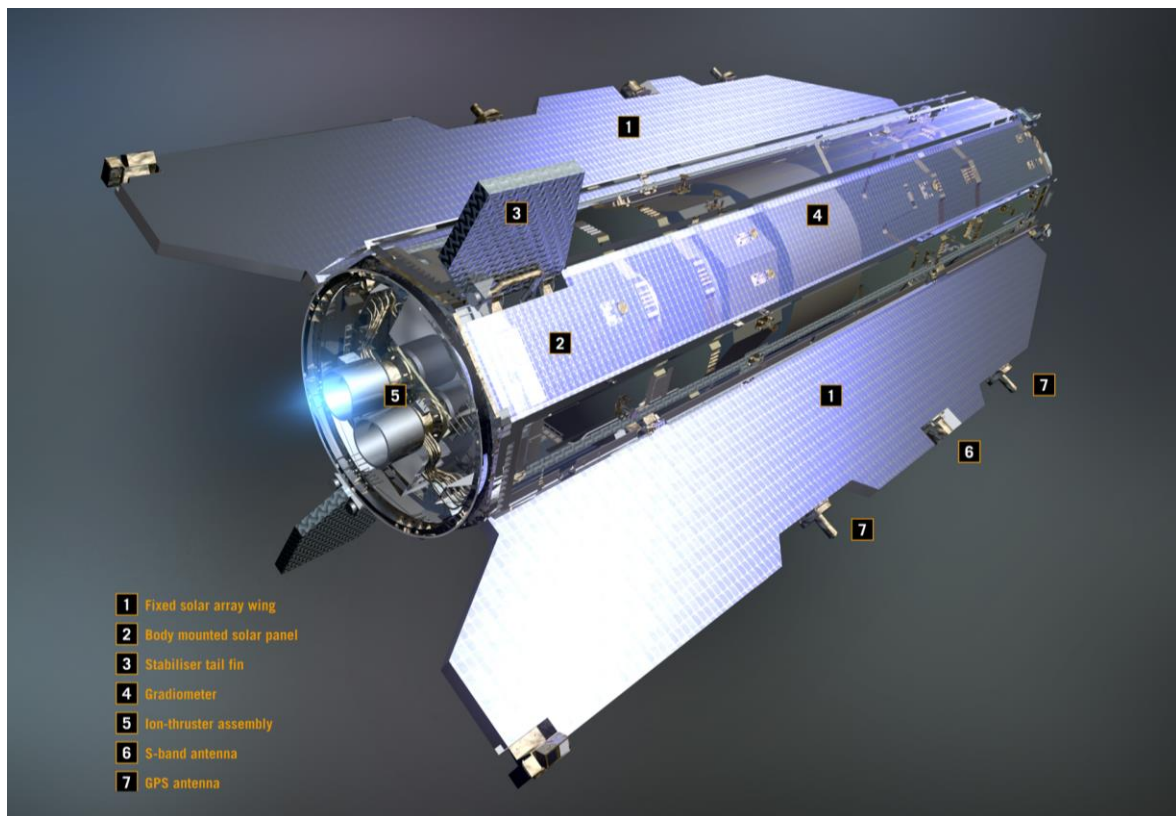

Figure 4-1: The GOCE Satellite and its Instruments

In summary, GOCE is a technologically very complex and demanding mission. The gravitational field sensor system consists of a three-axis gravitational gradiometer and GPS receiver as core instruments. Orientation in inertial space is derived from star sensors in combination with gradiometer observations. Common mode mode accelerations from the gradiometer and orbit positions from GPS are used together with ion thrusters for drag-free

control and with magneto-torquers for angular control. The principle of the system is shown in Figure 4-2 and, the system elements are summarized in Table 4-2.

Table 4-2: Elements of the Gravity Sensor System of GOCE

Element	Purpose
3-axis gravity gradiometer	Measures diagonal gravity gradients Γ_{xx} , Γ_{yy} , Γ_{zz} and off-diagonal gravity gradients Γ_{xy} , Γ_{xz} , Γ_{yz} in instrument system. Diagonal gravity gradients and Γ_{xz} are highly accurate in MBW (measurement bandwidth) Measures angular accelerations (highly accurate around y-axis, which is the satellite spin axis and less accurate around x, z axes) Measures common mode accelerations
Star sensors	Measure high rate and high precision inertial orientation
GPS receiver	Measures orbit trajectory with cm-precision
Laser retro reflector	Used for orbit validation.
Ion thrusters	Used for drag control. Control signal from common mode accelerations from gradiometer
Magneto-torquers	Angular control based on angular rates from star sensors and gradiometer
Cold gas thrusters	Gradiometer is calibrated in-flight with cold gas thrusters generating random pulses. The quadratic factors (non-linearities in accelerometer control system) are determined with sinusoidal motion of test masses of the accelerometers.

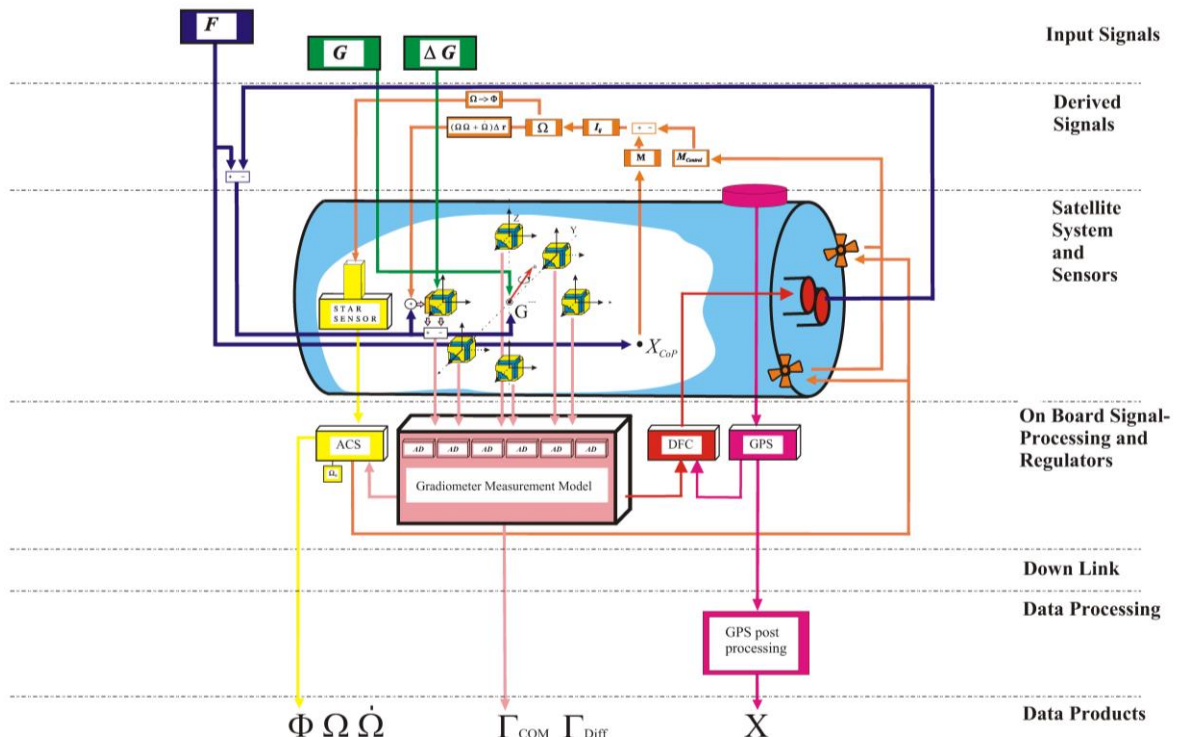

Figure 4-2: The GOCE Sensor System

		<p><i>GOCE Level 2 Product Data Handbook</i> Doc. Nr: GO-MA-HPF-GS-0110 Issue: 5.0 Date: 04.08.2014 Page: 18 of 84</p>
---	---	--

4.2 GOCE DATA PROCESSING OVERVIEW

Operational Ground Segment Elements

The European Space Agency has defined a ground system, which will prepare and process the GOCE observations up to so-called level 2 products. Level 2 products will be precise orbits, gravity gradients and GOCE gravity field models as well as quality indicators associated to them. These level 2 products will be available to the users in solid Earth physics, oceanography, geodesy and others. Figure 3-1 shows the structure of the ESA GOCE ground system elements and their interrelations.

- FOS: The Flight Operation System controls the satellite and receives the raw telemetry data on ground.
- PDS: The Payload Data System processes from raw observations (level 0) corrected and internally calibrated instrumental data sets with physical meaning (e.g. GPS range and phase observations, gravity gradients)(level 1b).
- CMF: The Calibration and Monitoring Facility permanently monitors the quality of the level 1b data by applying dedicated test algorithms.
- HPF: The High level Processing Facility generates from level 1b data the final GOCE orbits and gravity field products (level 2).

Supporting elements to these four kernel elements are the satellite prime contractor providing support on the instrument performance analysis, the auxiliary data providers providing supporting data sets to perform the processing tasks and the long-term archive and user service facility providing finally the GOCE products to the user community.

The GOCE High Level Processing Facility (HPF)

The HPF is as a distributed system developed and operated by the European GOCE Gravity Consortium (EGG-C). In order to fulfil the mission objectives, a dedicated scientific data analysis and processing system is implemented (Rummel et al, 2004). The major processing tasks of the HPF are as follows:

- The generation of calibrated GOCE gravity gradient products (external calibration of gradiometer data, transformation to terrestrial reference frame): The level 1b gradiometer products are already internally calibrated. This means on the hand that the non-linearity in the accelerometers feedback loop has been determined and physically adjusted to zero. On the other hand calibration parameters are applied to the accelerations. The calibration parameters and non-linearities are derived from a dedicated data analysis of observations taken during satellite and electronic shaking manoeuvres. However, at this point the relationship between the observed gravity gradients and real gravity field is still to be established. In order to do so an external scientific calibration of the gravity gradients is performed by comparison with existing gravity information. In addition, these level 2 gravity gradients in the gradiometer reference frame are transformed to a terrestrial reference frame.

		<p><i>GOCE Level 2 Product Data Handbook</i> Doc. Nr: GO-MA-HPF-GS-0110 Issue: 5.0 Date: 04.08.2014 Page: 19 of 84</p>
--	---	--

- The generation of GOCE validation products (quick-look gravity field and orbit solutions for data validation): Level 1b products from both sensors, SSTI and SGG, have to be validated in order to warrant a continuously high quality data flow, which is required to meet the mission objectives. For this reason the HPF implements several validation tools, which permanently monitor the quality of the level 1b products by derivation of so-called quick-look or rapid products on a level 2 basis. This means orbit and gravity field solutions are systematically generated from partial data sets of new GOCE observations with latencies of a few days. These solutions are further evaluated in order to find out whether the mission performance requirements are met.
- The generation of orbits and gravity fields from level 1b products generated by the PDS (nominal and calibrated products from the gradiometer and the GPS-receiver): The level 1b products consist mainly of gravity gradients in the gradiometer reference frame, gradiometer attitude quaternions and pseudo-ranges and phases from the GPS receiver. They require a comprehensive scientific data processing before they can be used to compute satellite positions and velocities and gravity information in terms of a set of spherical harmonic coefficients (including their estimated full variance-covariance matrix), geoid heights, geoid height errors, geoid slopes and gravity anomalies.
- The acquisition of auxiliary data needed for level 2 products generation: The most important are Earth rotation parameters from the International Earth Rotation and Reference Systems Service (IERS), GPS orbit, clock and ground station data from the International GNSS Service (IGS), satellite laser ranging data from the International Laser Ranging Service (ILRS) and atmospheric parameters from the European Centre for Medium Range Weather Forecast (ECMWF). Apart from this a variety of supporting data like planetary ephemerides, solar flux, geomagnetic indices, tide models, digital terrain models, external gravity field information and others have to be acquired. The HPF will acquire all ancillary data, check their quality and store them in a local HPF processing archive as well as in the long term GOCE archive, in case they are required for reprocessing purposes.

In summary one can state that the HPF represents the interface between the pure satellite system (which is represented by the pre-processed level 1b products) and the science level 3 users. It applies scientific analysis techniques to the satellite observations in order to derive quantities adequate for level 3 analyses. This enables the exploitation of the mission in a multi-disciplinary approach.

4.3 GOCE LEVEL 2 PRODUCTS SUMMARY

During the level 2 processing various intermediate level 2 products are generated. They contain intermediate results necessary for the next processing step in sequence. These products are not foreseen to be provided as standard GOCE products to the users. Final level 2 products, which will be available to the GOCE user community are listed in Table 4-3. Pre-processed and calibrated gradiometer data and precise science orbits will be available with a latency of two weeks and precise orbits with a latency of four weeks. Both products represent the main input to the gravity field processors. The final gravity field solution will be available

about 6 months after completion of each measurement operations phase. The transformed gravity gradients in an Earth fixed frame will be available after approximately 1 month.

All GOCE level 2 products are available to the user community via the ESA GOCE user service interface. The products are provided in XML format in order to enhance the products readability and the in-file data definitions (see chapter 5.3).

Table 4-3: List of GOCE Level-2 End User Data Products.

Product Name	Product Definition	Remarks
Gravity Gradients		
EGG_NOM_2_	L2 gravity gradients in GRF (see chapter 4.4.1) with corrections: <ul style="list-style-type: none"> • Externally calibrated and corrected gravity gradients • Corrections to gravity gradients due to temporal gravity variations • Flags for outliers, fill-in gravity gradients for data gaps with flags • Gravity gradient error estimates 	Latency 2 weeks
EGG_TRF_2_	L2 gravity gradients in LNOF (see chapter 4.4.1) with corrections: <ul style="list-style-type: none"> • Externally calibrated gravity gradients in local north oriented frame including corrections to gravity gradients due to temporal gravity variations • Flags for outliers, fill-in gravity gradients for data gaps with flags • Gravity gradient error estimates 	Latency 1 month
GRD_SPW_2_	Grids of gravity gradients at satellite altitude from the space-wise approach	Latency 1 year
GRC_SPW_2_	Combined grids of vertical gravity gradients and gravity anomalies at ground level (10 km altitude) from space-wise approach.	Latency 1 year
GOCE Orbits		
SST_PSO_2_	Precise science orbits <ul style="list-style-type: none"> • Reduced-dynamic and kinematic precise science orbits • Rotation matrices between IRF and EFRF (see chapter 4.4.1) • Variance-covariance information for kinematic positions • Quality report for precise orbits 	Latency 4 weeks
GOCE Gravity Fields		
EGM_GOC_2_	Final GOCE gravity field model <ul style="list-style-type: none"> • Spherical harmonic series including error estimates • Grids of geoid heights, gravity anomalies and deflections of the vertical • Propagated error estimates in terms of geoid heights • Quality report for GOCE gravity field model 	Latency 6 months
EGM_GVC_2_	Variance-covariance matrix for the final gravity field in terms of spherical harmonic series	Latency 6 months, Only on physical media
SST_AUX_2_	Time variable gravity field due to non-tidal mass variations. 6-hourly time series of gravity field spherical harmonic series.	Latency 2 weeks

4.4 GENERAL DEFINITIONS AND CONVENTIONS

All details about general definitions and conventions applied for level 2 data processing are specified in [AD-12]. In the following a short summary describing the most essential definitions and conventions is provided.

4.4.1 Reference Frames and Time System

GRF - Gradiometer Reference Frame & ARF – Accelerometer Reference Frame

GRF is the coordinate system in which the components of the gravity gradient tensor are measured by GOCE (see Figure 4-3). The GRF represents the Three-Axis Gradiometer common reference for the mutual positioning and alignment of the three One Axis Gradiometers and for the positioning and orientation of the whole instrument with respect to external reference frames. Nominally the origins of all one-axis gradiometer reference frames (OAGRF) coincide in one intersection point. The corresponding axes of each of the 3 OAGRF's are parallel and point in the same directions. The corresponding 6 accelerometer reference frames (ARF) are parallel and point in the same direction.

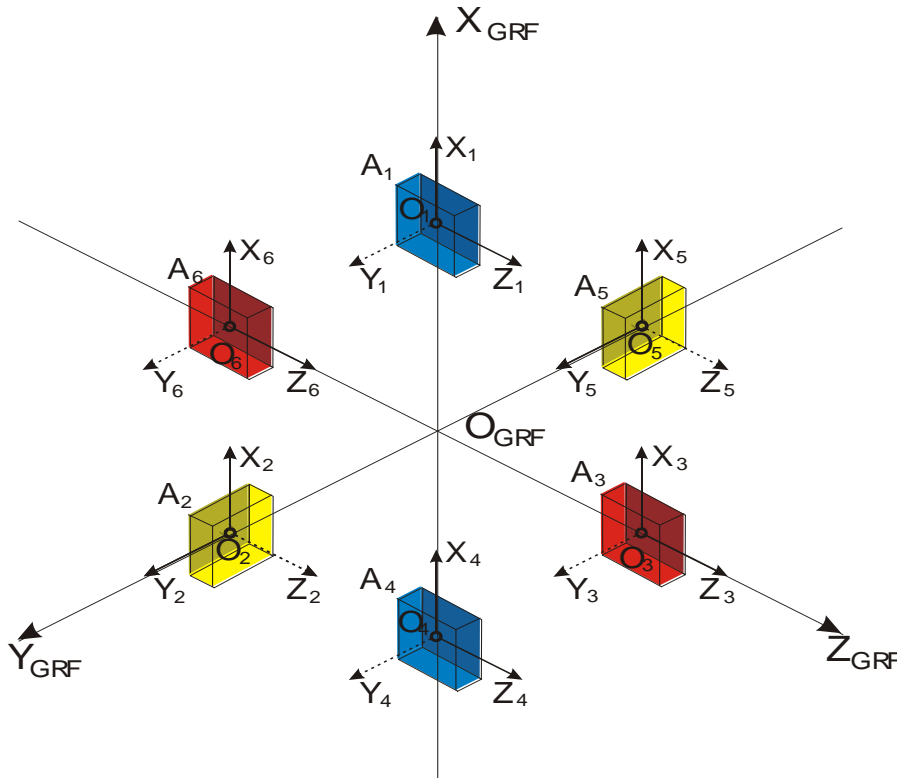

Figure 4-3: : Notation and location of the 6 accelerometers of the GOCE gradiometer in the GRF and with all 6 ARF's. The axes of the ARF shown by solid arrows are aligned with ultra sensitive axes of the accelerometer. The axes of the ARF shown by dashed arrows are aligned to the less sensitive axes of the accelerometer. Each colour represents a one-axis gradiometer. The shadowed surfaces represent the locations of the lower plates (and the sole plates).

LORF – Local Orbital Reference Frame

The origin O_{LORF} is located at the actual satellite centre of mass; X_{LORF} axis (roll) is parallel to instantaneous direction of the orbital velocity vector (\underline{V}) with the same sign as this vector. Y_{LORF} axis (pitch) is parallel to instantaneous direction of the orbital angular momentum (\underline{N}), with the same sign as \underline{N} (\underline{V} and \underline{N} are orthogonal by definition, since $\underline{N} = \underline{R} \times \underline{V}$, where \underline{R} is the vector from the Earth centre to the origin). The Z_{LORF} (yaw) axis is parallel to $\underline{V} \times \underline{N}$, with the same sign as $\underline{V} \times \underline{N}$

Orientation of GRF/LORF in Space

Figure 4-4 shows how the fundamental reference frames are related to each other. The GRF does not fully coincide with the LORF. In science mode the satellite will operate in drag-free mode for the flight direction only with platform attitude controlled by the magneto-torquers over the poles. Since the magneto-torquers can only operate close to the pole, the yaw steering mode allows the roll angle to accumulate at the equator by a few degrees. The maximum yaw angle value of 3.5° is reached at the equator due to out-of-plane forces caused by Earth rotation. Thus the satellite will be yaw steered to within $\pm 3.5^\circ$ (with respect to the LORF) in order to minimise lateral forces and torques.

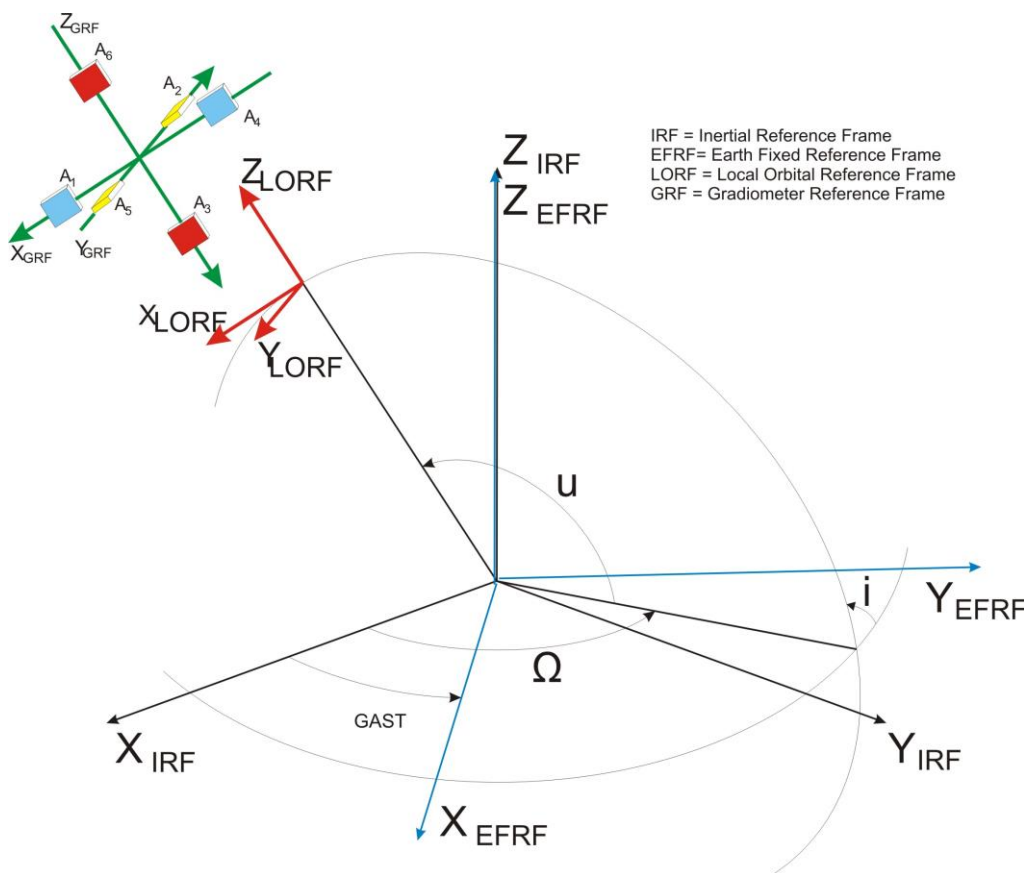

Figure 4-4: Definition of fundamental Reference Systems for GOCE

		<p><i>GOCE Level 2 Product Data Handbook</i> Doc. Nr: GO-MA-HPF-GS-0110 Issue: 5.0 Date: 04.08.2014 Page: 23 of 84</p>
---	---	--

Inertial Reference Frame (IRF)

The inertial reference frame (IRF) is a spatial reference system, which is fixed in space. The IRF is an orthogonal, right-handed system. Its origin is at the Earth's center of mass (geocenter), the orientation is equatorial, where the z-axis is the direction of the celestial pole. The x-axis is fixed in the equatorial plane in direction to the vernal equinox. A detailed description of the inertial reference system and the transformation between the inertial (celestial) and terrestrial (Earth-fixed) reference system is provided in [AD-12].

Earth-Fixed Reference Frame (EFRF)

The Earth-Fixed Reference System (EFRF) is a spatial reference system co-rotating with the Earth in its diurnal motion in space. The EFRF is an orthogonal, right-handed system. Its origin is at the Earth's center of mass (geocenter), the orientation is equatorial (z-axis is the direction of the pole). The x-axis is fixed in the equatorial plane in direction to the Greenwich meridian. The angle between the x-axis of the inertial reference frame (defined by the vernal equinox) and the Greenwich meridian is the Greenwich Apparent Sidereal Time (GAST).

Local North Oriented Frame (LNOF)

The Local North Oriented Frame (LNOF) is a right-handed North-West-Up frame with the X-axis pointing North, the Y-axis pointing West and the Z-axis Up. The calibrated gravity gradients of the EGG_TRF_2 products are provided in this system.

- The origin O_{LNOF} is located at the nominal satellite centre of mass
- Z_{LNOF} is defined as the vector from the geocenter to the origin O_{LNOF} , pointing radially outward,
- Y_{LNOF} is parallel to the normal vector to the plane of the geocentric meridian of the satellite center of mass, pointing westward,
- X_{LNOF} is parallel to the normal vector to the plane defined by Y_{LNOF} and Z_{LNOF} .

With respect to the geocentric latitude and East longitude (φ, λ) of the GOCE center of mass in the CTRS (Conventional Terrestrial Reference System, see [AD-12]) the 3 axes are defined as follows:

$$Z_{LNOF} = \begin{pmatrix} \cos \varphi \cos \lambda \\ \cos \varphi \sin \lambda \\ \sin \varphi \end{pmatrix}; Y_{LNOF} = \begin{pmatrix} \sin \lambda \\ -\cos \lambda \\ 0 \end{pmatrix}; X_{LNOF} = \begin{pmatrix} -\sin \varphi \cos \lambda \\ -\sin \varphi \sin \lambda \\ \cos \varphi \end{pmatrix}$$

Time System

All GOCE products are time-tagged in GPS time. This time will be derived by correlating the on-board time with the GPS time. In case no GPS time is available (due to receiver outage) the GPS time is automatically determined by correlating the on-board time with UTC and applying the constant and leap second time shift.

		<p><i>GOCE Level 2 Product Data Handbook</i> Doc. Nr: GO-MA-HPF-GS-0110 Issue: 5.0 Date: 04.08.2014 Page: 24 of 84</p>
---	---	--

4.4.2 Mathematical Conventions

4.4.2.1 Earth Orientation Quaternions

The rotation matrix provided together with the precise science orbit is defined in terms of quaternions. Earth Orientation Quaternions (EOQ) define the rotation between the Earth-Fixed Reference Frame (EFRF) and Inertial Reference Frame (IRF). Quaternions are used in the following way e.g. for a rotation of a vector from EFRF to IRF.

The quaternion q is defined in terms of Euler symmetric parameters q_1, q_2, q_3, q_4 :

$$q = q_4 + iq_1 + jq_2 + kq_3 \quad (4.1)$$

$$q_1 = e_1 \sin \frac{\Phi}{2}, \quad q_2 = e_2 \sin \frac{\Phi}{2}, \quad q_3 = e_3 \sin \frac{\Phi}{2}, \quad q_4 = \cos \frac{\Phi}{2}$$

where e_1, e_2, e_3 are components of the Euler axis and Φ is the corresponding rotation angle (the angle of the frame rotation around the axis defined by the unit vector (e_1, e_2, e_3)). The quantity q_4 is the real or scalar part of the quaternion and $iq_1 + jq_2 + kq_3$ is the imaginary or vector part. The i, j, k are the hyperimaginary numbers satisfying the conditions:

$$\begin{aligned} i^2 &= j^2 = k^2 = -1 \\ ij &= -ji = k \\ jk &= -kj = i \\ ki &= -ik = j \end{aligned} \quad (4.2)$$

The transformation of the orbit position and velocity given in the EFRF (Earth-Fixed Reference Frame) into the IRF (Inertial Reference Frame) is defined as:

$$\begin{aligned} X_{IRF} &= R X_{EFRF} \\ \dot{X}_{IRF} &= R \dot{X}_{EFRF} + \dot{R} X_{EFRF} \\ \ddot{X}_{IRF} &= R \ddot{X}_{EFRF} + \Omega R X_{EFRF} \end{aligned} \quad (4.3)$$

where the rotation matrix R is computed by:

$$R = \begin{bmatrix} q_1^2 - q_2^2 - q_3^2 + q_4^2 & 2(q_1q_2 + q_3q_4) & 2(q_1q_3 - q_2q_4) \\ 2(q_1q_2 - q_3q_4) & -q_1^2 + q_2^2 - q_3^2 + q_4^2 & 2(q_2q_3 + q_1q_4) \\ 2(q_1q_3 + q_2q_4) & 2(q_2q_3 - q_1q_4) & -q_1^2 - q_2^2 + q_3^2 + q_4^2 \end{bmatrix} \quad (4.4)$$

The skew-symmetric matrix Ω can be approximated with sufficient accuracy by:

		<p><i>GOCE Level 2 Product Data Handbook</i> Doc. Nr: GO-MA-HPF-GS-0110 Issue: 5.0 Date: 04.08.2014 Page: 25 of 84</p>
---	---	--

$$\Omega = \begin{bmatrix} 0 & \omega_3 & -\omega_2 \\ -\omega_3 & 0 & \omega_1 \\ \omega_2 & -\omega_1 & 0 \end{bmatrix} \approx \begin{bmatrix} 0 & \omega_3 & 0 \\ -\omega_3 & 0 & 0 \\ 0 & 0 & 0 \end{bmatrix} \quad (4.5)$$

$$\omega_3 = -7.2921151567 \cdot 10^{-5} \text{ rad / s}$$

Where $(\omega_1, \omega_2, \omega_3)$ are components of the instantaneous Earth rotation velocity in the IRF.

Using quaternions, computation of the rotation matrix can be avoided and the transformation can be replaced by the multiplication:

$$X_{IRF} = q^* X_{EFRF} q \quad (4.6)$$

where q^* denotes the conjugate or inverse quaternion q^* defined as

$$q^* = q_4 - iq_1 - jq_2 - kq_3 \quad (4.7)$$

and X_{EFRF} the position vector written in the form of a quaternion (scalar part is zero). The transformation from the EFRF into the IRF can be then computed as follows:

$$\begin{bmatrix} 0 \\ X_{IRF} \\ Y_{IRF} \\ Z_{IRF} \end{bmatrix} = \begin{bmatrix} q_4 & q_1 & q_2 & q_3 \\ -q_1 & q_4 & q_3 & -q_2 \\ -q_2 & -q_3 & q_4 & q_1 \\ -q_3 & q_2 & -q_1 & q_4 \end{bmatrix} \begin{bmatrix} q_4 & -q_1 & -q_2 & -q_3 \\ q_1 & q_4 & q_3 & -q_2 \\ q_2 & -q_3 & q_4 & q_1 \\ q_3 & q_2 & -q_1 & q_4 \end{bmatrix} \begin{bmatrix} 0 \\ X_{EFRF} \\ Y_{EFRF} \\ Z_{EFRF} \end{bmatrix} \quad (4.8)$$

The Earth orientation quaternions (EOQ' s) are provided for every integer second (t_0) of GPS time together with the orbit product. To get quaternion information for the actual epoch time t_{epo} , kinematic equation can be used to propagate quaternion information from the nearest integer second $q_{4 \times 1}(t_0)$:

$$q_{4 \times 1}(t_{epo}) = S_{4 \times 4} q_{4 \times 1}(t_0)$$

$$\Delta t = t_{epo} - t_0 \quad [s] \quad \omega = -7292115.1567 \cdot 10^{-11} \quad [rad / s]$$

$$S_{4 \times 4} = \begin{bmatrix} \cos\left(\frac{1}{2}\omega\Delta t\right) & -\sin\left(\frac{1}{2}\omega\Delta t\right) & 0 & 0 \\ \sin\left(\frac{1}{2}\omega\Delta t\right) & \cos\left(\frac{1}{2}\omega\Delta t\right) & 0 & 0 \\ 0 & 0 & \cos\left(\frac{1}{2}\omega\Delta t\right) & -\sin\left(\frac{1}{2}\omega\Delta t\right) \\ 0 & 0 & \sin\left(\frac{1}{2}\omega\Delta t\right) & \cos\left(\frac{1}{2}\omega\Delta t\right) \end{bmatrix} \quad (4.9)$$

		<p><i>GOCE Level 2 Product Data Handbook</i> Doc. Nr: GO-MA-HPF-GS-0110 Issue: 5.0 Date: 04.08.2014 Page: 26 of 84</p>
---	---	--

4.4.2.2 Interpolation of Quaternions

Given are two arbitrary normalized quaternions q_a and q_b defined in (4.1) referring to epochs t_a and t_b . Linear interpolation to an arbitrary epoch t may then be performed with the following algorithm. Due to the sign ambiguity and assuming that the angle between the two rotation axes described by q_a and q_b is smaller than 90° , the sign of all components of one of the quaternions has in a first step to be flipped if the scalar product of the vector parts of the two quaternions is negative:

$$q_b = -q_b \quad \text{if} \quad q_{a1}q_{b1} + q_{a2}q_{b2} + q_{a3}q_{b3} < 0 \quad (4.10)$$

The quaternion describing the differential rotation between the rotations q_b and q_a (rotation from epochs t_a to t_b) can be written by

$$q_{ab} = q_a^* q_b \quad (4.11)$$

or in components

$$\begin{aligned} q_{ab4} &= q_{a4}q_{b4} + q_{a1}q_{b1} + q_{a2}q_{b2} + q_{a3}q_{b3} \\ q_{ab1} &= q_{a4}q_{b1} - q_{a1}q_{b4} + q_{a3}q_{b2} - q_{a2}q_{b3} \\ q_{ab2} &= q_{a4}q_{b2} - q_{a2}q_{b4} + q_{a1}q_{b3} - q_{a3}q_{b1} \\ q_{ab3} &= q_{a4}q_{b3} - q_{a3}q_{b4} + q_{a2}q_{b1} - q_{a1}q_{b2} \end{aligned} \quad (4.12)$$

If $q_{ab} = 1$, interpolation is not necessary, the two quaternions q_a and q_b are equal.

The rotation angle corresponding to the rotation described by q_{ab} is

$$\Phi_{ab} = 2 \arccos(q_{ab4}) \quad (4.13)$$

This angle may be linearly interpolated

$$\Phi_{at} = \Phi_{ab} \frac{t - t_a}{t_b - t_a} \quad (4.14)$$

The quaternion corresponding to this interpolated rotation (rotation from epochs t_a to t) may be written as

$$q_{at4} = \cos \frac{\Phi_{at}}{2}, \quad q_{at1} = q_{ab1} \frac{\sin \frac{\Phi_{at}}{2}}{\sin \frac{\Phi_{ab}}{2}}, \quad q_{at2} = q_{ab2} \frac{\sin \frac{\Phi_{at}}{2}}{\sin \frac{\Phi_{ab}}{2}}, \quad q_{at3} = q_{ab3} \frac{\sin \frac{\Phi_{at}}{2}}{\sin \frac{\Phi_{ab}}{2}} \quad (4.15)$$

The quaternion q_t interpolating the quaternions q_a and q_b to epoch t can then be written as

		<p><i>GOCE Level 2 Product Data Handbook</i> Doc. Nr: GO-MA-HPF-GS-0110 Issue: 5.0 Date: 04.08.2014 Page: 27 of 84</p>
---	---	--

$$q_t = q_a q_{at} \quad (4.16)$$

or in components

$$\begin{aligned}
 q_{t4} &= q_{a4} q_{at4} - q_{a1} q_{at1} - q_{a2} q_{at2} - q_{a3} q_{at3} \\
 q_{t1} &= q_{a4} q_{at1} + q_{a1} q_{at4} - q_{a3} q_{at2} + q_{a2} q_{at3} \\
 q_{t2} &= q_{a4} q_{at2} + q_{a2} q_{at4} - q_{a1} q_{at3} + q_{a3} q_{at1} \\
 q_{t3} &= q_{a4} q_{at3} + q_{a3} q_{at4} - q_{a2} q_{at1} + q_{a1} q_{at2}
 \end{aligned} \quad (4.17)$$

4.4.2.3 Spherical Harmonic Series

The GOCE gravity field models and the non-tidal time variable gravity field corrections are provided in terms of a set of dimensionless coefficients of a spherical harmonic series up to a maximum degree of the gravity potential. These coefficients are the result of the gravity field determination process. All other quantities delivered together with the gravity field models are derived from these coefficients. The variance-covariance matrix product consists of the variances and covariances of and between all individual coefficients of the spherical harmonic series.

The gravitational potential spherical harmonic series is defined by (see e.g. Torge, 2001, p. 70 or Heiskanen/Moritz, 1967, p.59):

$$\begin{aligned}
 V(r, \theta, \lambda) &= W(r, \theta, \lambda) - Z(r, \theta, \lambda) = \\
 &= \frac{GM}{r} \sum_{n=0}^{N_{max}} \left(\frac{a}{r}\right)^n \sum_{m=0}^n (\bar{C}_{nm} \cos m\lambda + \bar{S}_{nm} \sin m\lambda) \bar{P}_{nm}(\cos \theta)
 \end{aligned} \quad (4.18)$$

where:	V	gravitational potential at computation point
	W	Earth's gravity potential (including the centrifugal potential)
	Z	centrifugal potential
	GM	gravitational constant times total mass of Earth (solid Earth, atmosphere, ocean) (Note: The factor GM is provided together with the spherical harmonic series)
	a	equatorial radius of the Earth ellipsoid used for the determination of the harmonic coefficients ($\bar{C}_{nm}, \bar{S}_{nm}$); (Note: This value is provided together with the spherical harmonic series)
	n	degree of spherical harmonic coefficient
	N_{max}	maximum degree of spherical harmonic series
	m	order of spherical harmonic coefficient
	r	radial distance of computation point from geocenter
	θ	geocentric co-latitude of computation point
	λ	(geocentric) longitude of computation point
	\bar{P}_{nm}	normalized associated Legendre functions of degree n and order m

		<p><i>GOCE Level 2 Product Data Handbook</i> Doc. Nr: GO-MA-HPF-GS-0110 Issue: 5.0 Date: 04.08.2014 Page: 28 of 84</p>
---	---	--

$\bar{C}_{nm}, \bar{S}_{nm}$ coefficients of the spherical harmonic series (normalized and dimensionless)

The coefficients of the spherical harmonic series are normalized. The following convention is used (Heiskanen/ Moritz, 1967, p.32; Torge, 2001, p.72):

$$\begin{aligned} \bar{C}_{n0} &= \frac{1}{\sqrt{2n+1}} C_{n0}, & \bar{P}_{n0}(\cos \theta) &= \sqrt{2n+1} \times P_{n0}(\cos \theta), \\ \left\{ \begin{array}{l} \bar{C}_{nm} \\ \bar{S}_{nm} \end{array} \right\} &= \sqrt{\frac{(n+m)!}{2(2n+1)(n-m)!}} \times \left\{ \begin{array}{l} C_{nm} \\ S_{nm} \end{array} \right\}, & \bar{P}_{nm}(\cos \theta) &= \sqrt{\frac{2(2n+1)(n-m)!}{(n+m)!}} \times P_{nm}(\cos \theta), \end{aligned} \quad (4.19)$$

where: C_{nm}, S_{nm} unnormalized coefficients of spherical harmonic series
 P_{nm} unnormalized associated Legendre functions of degree n and order m

The set of coefficients C_{nm}, S_{nm} or $\bar{C}_{nm}, \bar{S}_{nm}$ together with the chosen value GM and a form the spherical harmonic set.

4.4.2.4 Error Propagation

Together with the coefficients of the spherical harmonic series the variance-covariance matrix for the estimated coefficients is available. Error propagation from the spherical harmonic coefficients variance-covariance matrix to that of the observations is performed by:

$$\mathbf{Q}_{ll} = \mathbf{A} \mathbf{Q}_{xx} \mathbf{A}^T \quad (4.20)$$

with \mathbf{Q}_{ll} Variance-covariance matrix of the observations
 \mathbf{A} Coefficient matrix (partial derivatives of observation equation) connecting the coefficients with the observations
 \mathbf{Q}_{xx} Variance-covariance matrix of the spherical harmonic series

4.4.3 Gravity Field Conventions

The gravity potential expressed by the spherical harmonic series represents the total effect of the solid Earth mass, the atmospheric and the oceanic masses. The constants of the spherical harmonic series GM (gravitational constant times mass) and a (equatorial radius of the Earth) are provided together with the model coefficients. The atmosphere is assumed to be condensed at the surface of the sphere with radius a . All time variable mass variations are subtracted by models during the estimation procedure. This includes direct tides from Sun, Moon and planets, solid Earth tides, ocean tides and solid Earth pole tides. The product information includes an indicator whether permanent tides are included in the model (zero-

tide) or not (tide free). Also non-tidal mass variations in the atmosphere and the oceans are taken into account by using an atmospheric and oceanic model as well as by applying a recent GRACE gravity field time series . Details about the correction models and how they are applied are described in [AD-12].

From the gravity potential derived gravity quantities such as geoid heights, gravity anomalies and deflections of the vertical are directly computed using the spherical harmonic series and subtracting the spherical harmonic coefficients of the adopted reference potential. Before subtraction, the gravity field spherical harmonic series has to be scaled to the constants of the reference potential (see (4.21)). This includes the coefficient \bar{C}_{00} representing the zero-order part of the gravitational potential. The name of the adopted reference potential is provided in the header of the product files. When computing the derived gravity quantities the following pre-computations and assumptions are made:

1. In order to take into account the scale difference between the GOCE derived and the reference potential all coefficients are transformed to the constants of the reference potential. Equation (4.21) is based on the assumption that at any point above the Earth's surface the gravity potential W is constant and does not change due to the coefficients transformation. (The superscript "REF" indicates a constant taken from the adopted reference potential, "GOCE" means the constant is part of the gravity potential spherical harmonic solution).

$$\begin{Bmatrix} \bar{C}_{nm}^{ELL} \\ \bar{S}_{nm}^{ELL} \end{Bmatrix} = \left(\frac{GM^{GOCE}}{GM^{REF}} \right) \left(\frac{a^{GOCE}}{a^{REF}} \right)^n \begin{Bmatrix} \bar{C}_{nm}^{GOCE} \\ \bar{S}_{nm}^{GOCE} \end{Bmatrix} \quad (4.21)$$

with

GM^{REF}	Factor GM for the reference ellipsoid potential
GM^{GOCE}	Factor GM for the GOCE gravity spherical harmonic series
a^{REF}	Equatorial radius for the reference ellipsoid
a^{GOCE}	Equatorial radius for the GOCE gravity spherical harmonic series
$\bar{C}_{nm}^{ELL}, \bar{S}_{nm}^{ELL}$	Normalized spherical harmonic coefficients referring to the constants of the reference ellipsoid
$\bar{C}_{nm}^{GOCE}, \bar{S}_{nm}^{GOCE}$	Normalized spherical harmonic coefficients referring to the constants of the GOCE gravity spherical harmonic series

2. After rescaling the spherical harmonic coefficients to the set of constants of the reference potential the disturbing potential at a point P can be computed by (see for example Torge, 2001, p. 214, Heiskanen/Moritz, 1967, p.82):

$$T_p = W_p - U_p \quad (4.22)$$

with W_p gravity potential at point P (including centrifugal potential)

		<p><i>GOCE Level 2 Product Data Handbook</i> Doc. Nr: GO-MA-HPF-GS-0110 Issue: 5.0 Date: 04.08.2014 Page: 30 of 84</p>
---	---	--

U_p normal potential of reference ellipsoid at point P
(including centrifugal potential)
 T_p disturbing potential at point P

3. By subtracting the normal potential from the gravity potential the centrifugal potential drops out. As the gravitational potential (see (4.18)) also the normal potential can be expanded into a spherical harmonic series (compare Torge, 2001, p. 107):

$$U(r,\theta,\lambda)-Z(r,\theta,\lambda)=\frac{GM^{REF}}{r}\left(\bar{C}_0^{REF}+\sum_{n=2(2)}^8\left(\frac{a^{REF}}{r}\right)^n\bar{C}_n^{REF}\bar{P}_n(\cos\theta)\right) \quad (4.23)$$

with \bar{C}_n^{REF} normalized coefficient of spherical harmonic series of the reference ellipsoid of degree n and order 0
 $\bar{C}_0^{REF} = 1$
 \bar{P}_n normalized Legendre polynomial of degree n

4. The normalized coefficients of the spherical harmonic series of the reference ellipsoid are computed by (Heiskanen/Moritz, 1967, equ. 2-92 and page 78 top) :

$$\bar{C}_{2k}^{REF} = (-1)^k \frac{3(e^{REF})^{2k}}{(2k+3)(2k+1)\sqrt{4k+1}} \left[1 + \frac{2}{3}k \left(1 - \frac{m_\gamma e'^{REF}}{3q_0} \right) \right] \quad (4.24)$$

The series is rapidly convergent and in practical computations it can be truncated at k=4 without losing accuracy.

with $n=2k, (k=1,2,3,4)$
 e^{REF} as defined in (4.26)
 e'^{REF}, m_γ, q_0 as defined in (4.34) and follow-on equations

5. The spherical harmonic series of the disturbing potential for the point P with the coordinates r, θ, λ then becomes:

$$T(r,\theta,\lambda)=\frac{GM^{REF}}{r}\sum_{n=0}^{N_{max}}\left(\frac{a^{REF}}{r}\right)^n\sum_{m=0}^n(\Delta\bar{C}_{nm}\cos m\lambda+\Delta\bar{S}_{nm}\sin m\lambda)\bar{P}_{nm}(\cos\theta) \quad (4.25)$$

with $\Delta\bar{C}_{nm}, \Delta\bar{S}_{nm}$ residual coefficients of the spherical harmonic series after subtracting the coefficients of the normal potential from the gravitational potential.

Employing an ellipsoidal reference field this means for all residual coefficients except for degrees 0,2,4,6,8 and zero order that the following relation holds:

$$\Delta \bar{C}_{nm} = \bar{C}_{nm}^{ELL} ; \Delta \bar{S}_{nm} = \bar{S}_{nm}^{ELL}$$

For the coefficients of degree $n=2,4,6,8$ and zero order the residual coefficients are defined by:

$$\Delta \bar{C}_{n0} = \bar{C}_{n0}^{ELL} - \bar{C}_n^{REF}$$

And for the degree 0 term the residual coefficient is defined by:

$$\Delta \bar{C}_{00} = \bar{C}_{00}^{ELL} - 1$$

4.4.3.1 Approximations for Derived Quantities

The series expansion of the normal potential (see equation (4.23)) is truncated at $n=8$. This means that for the normal potential only the spherical harmonic coefficients $\bar{C}_0^{REF}, \bar{C}_2^{REF}, \bar{C}_4^{REF}, \bar{C}_6^{REF}, \bar{C}_8^{REF}$ are taken into account (with $\bar{C}_0^{REF} = 1$).

In order to obtain gravity field quantities like geoid heights, gravity anomalies and deflections of the vertical from the GOCE gravity potential harmonic series some approximations are introduced. This is done in order to avoid any dependency on a topography data set. In the following it is described how these derived products are computed and what approximations are applied. For a rigorous formulation see chapter 4.4.3.2.

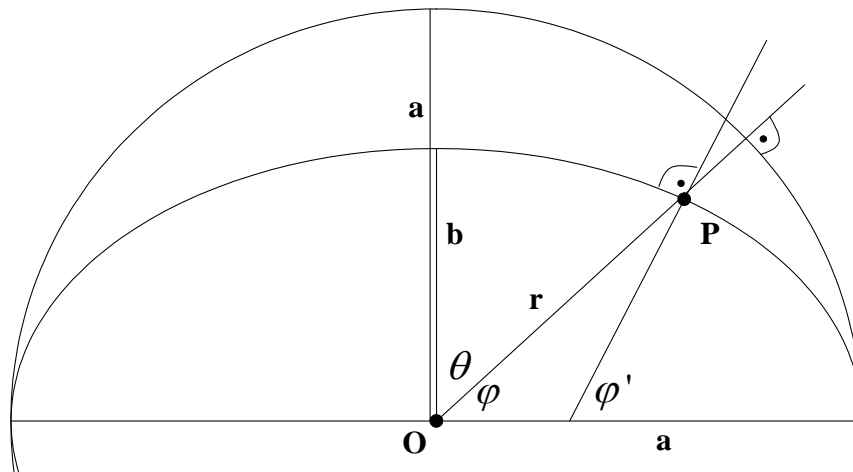

Figure 4-5: Geometry of the ellipsoid (the ellipsoidal longitude λ' and geocentric longitude λ are identical. It holds for all points P: $\lambda = \lambda'$)

Note: the coordinates of the grid data files described in chapter 5.3 are given as geodetic (ellipsoidal) latitude and longitude.

The computation points P for the derived quantities are located on the reference ellipsoid (see Figure 4-5). Each point on the ellipsoid is defined by the set of geodetic (ellipsoidal)

		<p><i>GOCE Level 2 Product Data Handbook</i> Doc. Nr: GO-MA-HPF-GS-0110 Issue: 5.0 Date: 04.08.2014 Page: 32 of 84</p>
---	---	--

coordinates (φ', λ', r) (see Figure 4-5). The radial distance r from the geocenter to the computation point P is computed for each given geocentric latitude φ (or co-latitude θ). First the geodetic (ellipsoidal) latitude φ' is transformed to the corresponding geocentric value φ applying formula (4.27) (see Torge, 2001, equations 4.1b and 4.11a).

$$\frac{b^{REF}}{a^{REF}} = \sqrt{1 - (e^{REF})^2} ; e^{REF} = \frac{\sqrt{(a^{REF})^2 - (b^{REF})^2}}{a^{REF}} \quad (4.26)$$

$$\tan \varphi = \left(1 - (e^{REF})^2\right) \tan \varphi' \quad (4.27)$$

where: φ' geodetic (ellipsoidal) latitude
 φ geocentric latitude
 a^{REF} semi major axis of the reference ellipsoid
 b^{REF} semi minor axis of the reference ellipsoid
 e^{REF} first eccentricity of the reference ellipsoid

The geocentric distance of the computation point P on the reference ellipsoid can be calculated as a function of the geodetic latitude by the following formulas (compare Torge, 2001, equations 4.6, 4.8, 4.9):

$$\begin{aligned} \bar{X} &= \frac{(a^{REF})^2 \cos \varphi' \cos \lambda'}{\sqrt{(a^{REF})^2 \cos^2 \varphi' + (b^{REF})^2 \sin^2 \varphi'}} \\ \bar{Y} &= \frac{(a^{REF})^2 \cos \varphi' \sin \lambda'}{\sqrt{(a^{REF})^2 \cos^2 \varphi' + (b^{REF})^2 \sin^2 \varphi'}} \\ \bar{Z} &= \frac{(b^{REF})^2 \sin \varphi'}{\sqrt{(a^{REF})^2 \cos^2 \varphi' + (b^{REF})^2 \sin^2 \varphi'}} \end{aligned} \quad (4.28)$$

$$\begin{aligned} r &= \sqrt{p^2 + \bar{Z}^2} \\ p &= \sqrt{\bar{X}^2 + \bar{Y}^2} \end{aligned} \quad (4.29)$$

Alternatively one can compute it as a function of the geocentric latitude as:

$$r = a^{REF} \frac{\sqrt{1 - (e^{REF})^2}}{\sqrt{1 - (e^{REF} \cos \varphi)^2}} \quad (4.30)$$

For evaluating equation (4.25) the geocentric co-latitude θ , the longitude λ and the geocentric distance r is used. As the geocentric distance (r) is always equal or less than the semi major

		<p><i>GOCE Level 2 Product Data Handbook</i> Doc. Nr: GO-MA-HPF-GS-0110 Issue: 5.0 Date: 04.08.2014 Page: 33 of 84</p>
---	---	--

axis of the reference ellipsoid a^{REF} formula (4.25) is evaluated on or inside the sphere with radius a^{REF} . Over the oceans the computation points P are always close to the real ocean surface, while over continental areas they refer to points that are in reality located inside the continental masses. They have to be regarded as downward continued (to the ellipsoid) mathematical values. For any geophysical interpretation of these derived quantities this fact must be taken into account. (Note: in case of evaluation of equation (4.25) for an equi-angular grid on the reference ellipsoid the degree dependent term as well as the associated Legendre polynomials only have to be recomputed once for each parallel).

The geoid height is defined as the distance between the ellipsoid and the geoid. The geoid is defined by the condition that its potential equals to the constant normal potential of the corresponding point on the reference ellipsoid. By applying Bruns formula to equation (4.25) we get the relation between geoid heights and the disturbing potential ((Heiskanen / Moritz, 1967, p. 85, Torge, 2001, p. 258).

$$N = \frac{T}{\gamma_0} \quad (4.31)$$

where: N geoid height
 T disturbing potential on the geoid
 γ_0 normal gravity at reference ellipsoid

The normal gravity at the reference ellipsoid is computed by the formula of Somigliana (see Torge, 2001, p. 106, equation 4.41b):

$$\gamma_0(\varphi') = \gamma_a \frac{1 + k \sin^2 \varphi'}{\sqrt{1 - (e^{REF})^2 \sin^2 \varphi'}} ; k = \frac{b^{REF} \gamma_b}{a^{REF} \gamma_a} - 1 \quad (4.32)$$

with: γ_a normal gravity at the equator
 γ_b normal gravity at the pole

The normal gravity at the equator and at the poles are computed by (see Heiskanen / Moritz, 1967, p. 69, equations 2-73 and 2-74):

$$\gamma_a = \frac{GM^{REF}}{a^{REF} b^{REF}} \left(1 - m_\gamma - \frac{m_\gamma e'^{REF} q'_0}{6 q_0} \right)$$

$$\gamma_b = \frac{GM^{REF}}{(a^{REF})^2} \left(1 + \frac{m_\gamma e'^{REF} q'_0}{3 q_0} \right) \quad (4.33)$$

with $m_\gamma = \frac{(\omega^{REF})^2 (a^{REF})^2 b^{REF}}{GM^{REF}} \quad (4.34)$

		<p><i>GOCE Level 2 Product Data Handbook</i> Doc. Nr: GO-MA-HPF-GS-0110 Issue: 5.0 Date: 04.08.2014 Page: 34 of 84</p>
---	---	--

ω^{REF} rotational velocity of reference ellipsoid (provided together with ellipsoid parameters)

$$e'^{REF} = \frac{\sqrt{(a^{REF})^2 - (b^{REF})^2}}{b^{REF}} \quad \text{second eccentricity of ellipsoid}$$

$$q_0 = \frac{1}{2} \left[\left(1 + \frac{3}{(e'^{REF})^2} \right) \tan^{-1} e'^{REF} - \frac{3}{e'^{REF}} \right]$$

$$q'_0 = 3 \left(1 + \frac{1}{(e'^{REF})^2} \right) \left(1 - \frac{\tan^{-1} e'^{REF}}{e'^{REF}} \right) - 1$$

By applying equation (4.31) to equation (4.25) the geoid heights as defined above can be written as a spherical harmonic series.

$$N(r, \theta, \lambda) = \frac{GM^{REF}}{r\gamma_0} \sum_{n=0}^N \left(\frac{a^{REF}}{r} \right)^n \sum_{m=0}^n (\Delta\bar{C}_{nm} \cos m\lambda + \Delta\bar{S}_{nm} \sin m\lambda) \bar{P}_{nm}(\cos\theta) \quad (4.35)$$

Gravity anomalies are derived from the fundamental equation of physical geodesy introducing the derivatives along the plumb line of the disturbing potential and the normal gravity (see Heiskanen / Moritz, 1967, p.86).

$$\Delta g = g_p - \gamma_0 = -\frac{\partial T}{\partial h} + \frac{1}{\gamma_0} \frac{\partial \gamma}{\partial h} T \quad (4.36)$$

with g_p magnitude of gravity at the geoid

In spherical approximation (by approximating the real plumb line with the geocentric vector) it becomes (Heiskanen / Moritz, 1967, p. 88):

$$\Delta g = -\frac{\partial T}{\partial r} - \frac{2}{a^{REF}} T \quad (4.37)$$

By applying the spherical approximation of (4.37) to equation (4.25) we get the spherical harmonic series for the gravity anomalies:

$$\Delta g(r, \theta, \lambda) = \frac{GM^{REF}}{r^2} \sum_{n=0}^N (n-1) \left(\frac{a^{REF}}{r} \right)^n \sum_{m=0}^n (\Delta\bar{C}_{nm} \cos m\lambda + \Delta\bar{S}_{nm} \sin m\lambda) \bar{P}_{nm}(\cos\theta) \quad (4.38)$$

The above formulas are given in spherical approximation.

		<p><i>GOCE Level 2 Product Data Handbook</i> Doc. Nr: GO-MA-HPF-GS-0110 Issue: 5.0 Date: 04.08.2014 Page: 35 of 84</p>
---	---	--

In a similar way the deflections of the vertical are defined in spherical approximation as (see Heiskanen / Moritz, 1967, p. 112, equation 2-204, note: Formulas have been updated by inserting the co-latitude):

$$\zeta = \frac{1}{a^{REF}} \frac{\partial N}{\partial \theta} \quad ; \quad \eta = -\frac{1}{a^{REF} \sin \theta} \frac{\partial N}{\partial \lambda} \quad (4.39)$$

where ζ North-South deflection of the vertical at computation point
positive towards North
 η East-West deflection of the vertical at computation point
positive towards East

By applying the formulas (4.39) to (4.35) we get the spherical harmonic series expansions for both components of the vertical deflections.

$$\xi(r, \theta, \lambda) = \frac{GM^{REF}}{a^{REF} r \gamma_0} \sum_{n=0}^N \left(\frac{a^{REF}}{r} \right)^n \sum_{m=0}^n (\Delta \bar{C}_{nm} \cos m\lambda + \Delta \bar{S}_{nm} \sin m\lambda) \frac{\partial \bar{P}_{nm}(\cos \theta)}{\partial \theta} \quad (4.40)$$

$$\eta(r, \theta, \lambda) = -\frac{GM^{REF}}{a^{REF} r \gamma_0 \sin \theta} \sum_{n=0}^N \left(\frac{a^{REF}}{r} \right)^n \sum_{m=0}^n (-m \Delta \bar{C}_{nm} \sin m\lambda + m \Delta \bar{S}_{nm} \cos m\lambda) \bar{P}_{nm}(\cos \theta) \quad (4.41)$$

The derivative of the associated Legendre functions can be computed with the following formula (see Kautzleben, 1965):

$$2 \frac{\partial \bar{P}_{n,m}(\cos \theta)}{\partial \theta} = \left\{ \begin{array}{ll} -\sqrt{2n(n+1)} \bar{P}_{n,1}(\cos \theta) & (m=0) \\ \sqrt{2n(n+1)} \bar{P}_{n,0}(\cos \theta) - \sqrt{(n-1)(n+2)} \bar{P}_{n,2}(\cos \theta) & (m=1) \\ \sqrt{(n+m)(n-m+1)} \bar{P}_{n,m-1}(\cos \theta) - \sqrt{(n-m)(n+m+1)} \bar{P}_{n,m+1}(\cos \theta) & (m>1) \end{array} \right\} \quad (4.42)$$

4.4.3.2 More Accurate Formulations for Derived Quantities

In order to avoid downward continuation inside the masses to the reference ellipsoid, Molodensky introduced the Earth surface as boundary surface, where the spherical harmonic series is evaluated. This implies that several approximations introduced before are not applicable anymore and a more rigorous formulation has to be applied.

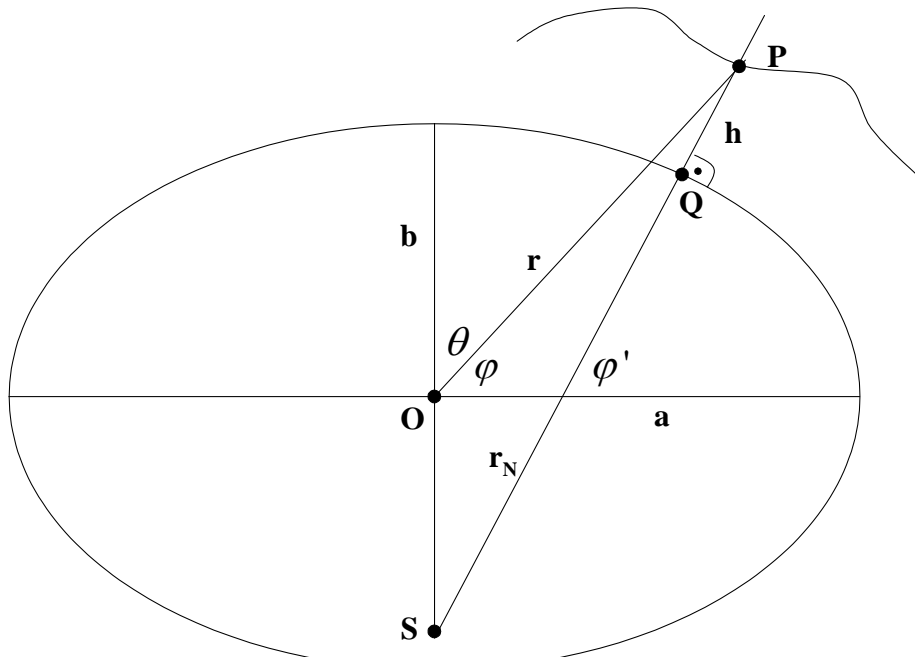

Figure 4-6: Geometry for a point P on the Earth's surface and the ellipsoid. (the ellipsoidal longitude λ' and geocentric longitude λ are identical. It holds for all points P: $\lambda=\lambda'$)

The computation points P for the derived quantities are located on the Earth's surface (see Figure 4-6). As for the case when P is located on the ellipsoid the radial distance r from the geocenter to the computation point P is computed for each given geocentric latitude φ (or co-latitude θ) and for the height h of the point above the ellipsoid (distance point Q-P).

First, the normal radius of the curvature r_N^{REF} (distance point S-Q) is computed by (see Torge, 2001, p. 96, equation 4-15) (with e^{REF} defined by equation (4.26)):

$$r_N^{REF} = \frac{a^{REF}}{\sqrt{1 - (e^{REF})^2 \sin^2 \varphi'}} \quad (4.43)$$

The geocentric latitude and the radial distance are computed by (Torge, 2001, p. 100, equation 4-27):

$$\begin{aligned}
 \bar{X} &= (r_N^{REF} + h) \cos \varphi' \cos \lambda' \\
 \bar{Y} &= (r_N^{REF} + h) \cos \varphi' \sin \lambda' \\
 \bar{Z} &= \left(\left(1 - (e^{REF})^2 \right) r_N^{REF} + h \right) \sin \varphi' \\
 \varphi &= \arctan \frac{\bar{Z}}{\sqrt{\bar{X}^2 + \bar{Y}^2}} ; \theta = 90^\circ - \varphi \\
 \lambda &= \arctan \frac{\bar{Y}}{\bar{X}} \\
 r &= \sqrt{\bar{X}^2 + \bar{Y}^2 + \bar{Z}^2}
 \end{aligned}
 \tag{4.44}$$

In order to compute the disturbing potential at the Earth's surface, equation (4.25) is evaluated using the geocentric co-latitude θ , the longitude λ and the geocentric distance r as they are defined in equations (4.44). This means that for each point on the Earth's surface the degree dependent term in equation (4.25) $(a^{REF} / r)^n$ as well as the normalized associated Legendre polynomials $\bar{P}_{nm}(\cos \theta)$ have to be recomputed, because φ and r are dependent on the height h of each point. (Note: in case of evaluation of equation (4.25) for an equi-angular grid on the reference ellipsoid the degree dependent term as well as the associated Legendre polynomials only have to be recomputed only once for each parallel).

Before gravity quantities derived from the disturbing potential can be computed, the different height systems have to be introduced (see Figure 4-7).

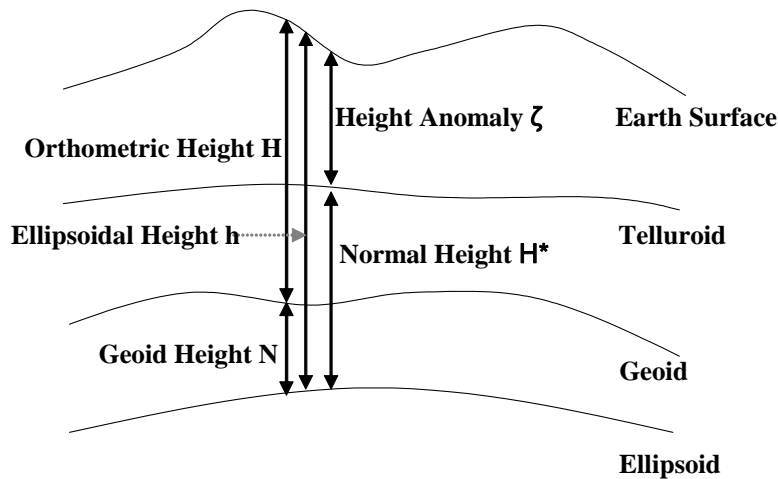

Figure 4-7: Definition of Height Systems

The height anomaly is defined as the distance between the telluroid and the Earth's surface. The telluroid is defined by the condition that the normal potential at the telluroid point equals to the gravity potential of the corresponding point on the Earth's surface. By applying Bruns formula to equation (4.25) for the disturbing potential on the Earth's surface we get the

		<p><i>GOCE Level 2 Product Data Handbook</i> Doc. Nr: GO-MA-HPF-GS-0110 Issue: 5.0 Date: 04.08.2014 Page: 38 of 84</p>
---	---	--

relation between height anomalies and the disturbing potential ((Heiskanen / Moritz, 1967, p. 293, equation 8-10).

$$\zeta = \frac{T}{\gamma} \quad (4.45)$$

where: ζ height anomaly
 T disturbing potential on the Earth's surface
 γ normal gravity acceleration at telluroid

By applying equation (4.45) to equation (4.25) the height anomalies as defined above are written as a spherical harmonic series:

$$\zeta(r, \theta, \lambda) = \frac{GM^{REF}}{r\gamma} \sum_{n=0}^N \left(\frac{a^{REF}}{r} \right)^n \sum_{m=0}^n (\Delta\bar{C}_{nm} \cos m\lambda + \Delta\bar{S}_{nm} \sin m\lambda) \bar{P}_{nm}(\cos \theta) \quad (4.46)$$

where r now is the distance from the geocenter to the point on the Earth's surface (compare Figure 4-6) and where γ is computed at topographic height H^* (see Heiskanen / Moritz, p. 79, equation 2-123):

$$\gamma = \gamma_0 \left(1 - \frac{2}{a^{REF}} (1 + f^{REF} + m_\gamma - 2f^{REF} \sin^2 \varphi') H^* + \frac{3}{(a^{REF})^2} (H^*)^2 \right) \quad (4.47)$$

with γ_0 normal gravity on the reference ellipsoid (see equation (4.32))
 f^{REF} flattening of the ellipsoid $f^{REF} = \frac{a^{REF} - b^{REF}}{a^{REF}}$
 m_γ centrifugal force at equator divided by gravitational acceleration at the equator (see equation (4.34))
 H^* normal height

In order to compute height anomalies from a spherical harmonic series of the disturbing potential we have to know the normal heights of the telluroid points. Since not for all areas in the world normal heights are available (depending on the height system used in each country) they could be approximated by orthometric heights, which are also often used as height system. The difference between the normal and orthometric heights is equal to the difference between height anomalies and geoid heights (see Heiskanen / Moritz, 1967, page 327, equation 8-102). It can reach up to a few decimeters or more in mountainous areas (e.g. 0.5 meters for Mont Blanc with an elevation of 4807 meters).

Free-air gravity anomalies (referring to ground level) are defined by the difference of the scalar gravity on the surface of the Earth and the normal gravity on the telluroid (see Heiskanen / Moritz, 1967, p.293, equation 8-7).

		<i>GOCE Level 2 Product Data Handbook</i> Doc. Nr: GO-MA-HPF-GS-0110 Issue: 5.0 Date: 04.08.2014 Page: 39 of 84
---	---	---

$$\Delta g = g_p - \gamma \quad (4.48)$$

with g_p magnitude of gravity at Earth' surface
 γ magnitude of normal gravity at telluroid

In order to avoid spherical approximation (as in equation (4.37)) the magnitudes of both vectors are computed by the gradients of the gravitational potential and the normal potential, respectively, applying the following local right handed rectangular coordinate system: x positive towards the North, y positive towards the West, z: from geocenter to local origin pointing radially outward (compare LNOF system defined in 4.4.1).

$$g_p = |\text{grad } W_p| = \sqrt{\left(\frac{\partial W}{\partial x}\right)_p^2 + \left(\frac{\partial W}{\partial y}\right)_p^2 + \left(\frac{\partial W}{\partial z}\right)_p^2} \quad (4.49)$$

$$\gamma = |\text{grad } U| = \sqrt{\left(\frac{\partial U}{\partial x}\right)^2 + \left(\frac{\partial U}{\partial y}\right)^2 + \left(\frac{\partial U}{\partial z}\right)^2}$$

from (4.18), after transformation of the coefficients to the constants of the reference ellipsoid applying equation (4.21) and from (4.23) and (4.24), after some rearrangement and introduction of geocentric spherical coordinates, the gravity and normal potentials are defined as spherical harmonic series including the centrifugal potential by (see Torge, 2001, p. 55, equation 3.38 for the centrifugal potential):

$$W(r, \theta, \lambda) = \frac{GM^{REF}}{a^{REF}} \sum_{n=0}^{N_{max}} \left(\frac{a^{REF}}{r}\right)^{n+1} \sum_{m=0}^n (\bar{C}_{nm}^{ELL} \cos m\lambda + \bar{S}_{nm}^{ELL} \sin m\lambda) \bar{P}_{nm}(\cos \theta) + \frac{1}{2} (\omega^{REF})^2 r^2 \sin^2 \theta \quad (4.50)$$

$$U(r, \theta, \lambda) = \frac{GM^{REF}}{a^{REF}} \left(\sum_{n=0(2)}^8 \left(\frac{a^{REF}}{r}\right)^{n+1} \bar{C}_n^{REF} \bar{P}_n(\cos \theta) \right) + \frac{1}{2} (\omega^{REF})^2 r^2 \sin^2 \theta \quad (4.51)$$

The derivatives of the gravity potential, after introducing spherical coordinates, are then computed by (compare to equations (4.40) and (4.41)):

		<p><i>GOCE Level 2 Product Data Handbook</i> Doc. Nr: GO-MA-HPF-GS-0110 Issue: 5.0 Date: 04.08.2014 Page: 40 of 84</p>
---	---	--

$$\begin{aligned}
 -\frac{\partial W}{\partial x} &= \frac{\partial W}{r \partial \theta} = \frac{GM^{REF}}{ra^{REF}} \sum_{n=0}^{N_{max}} \left(\frac{a^{REF}}{r} \right)^{n+1} \sum_{m=0}^n (\bar{C}_{nm}^{ELL} \cos m\lambda + \bar{S}_{nm}^{ELL} \sin m\lambda) \frac{\partial \bar{P}_{nm}(\cos \theta)}{\partial \theta} + \\
 &\quad + (\omega^{REF})^2 r \sin \theta \cos \theta \\
 -\frac{\partial W}{\partial y} &= \frac{\partial W}{r \sin \theta \partial \lambda} = \frac{GM^{REF}}{r \sin \theta a^{REF}} \sum_{n=0}^{N_{max}} \left(\frac{a^{REF}}{r} \right)^{n+1} \sum_{m=0}^n (-m \bar{C}_{nm}^{ELL} \sin m\lambda + m \bar{S}_{nm}^{ELL} \cos m\lambda) \bar{P}_{nm}(\cos \theta) \\
 \frac{\partial W}{\partial z} &= \frac{\partial W}{\partial r} = -\frac{GM^{REF}}{ra^{REF}} \sum_{n=0}^{N_{max}} (n+1) \left(\frac{a^{REF}}{r} \right)^{n+1} \sum_{m=0}^n (\bar{C}_{nm}^{ELL} \cos m\lambda + \bar{S}_{nm}^{ELL} \sin m\lambda) \bar{P}_{nm}(\cos \theta) + \\
 &\quad + (\omega^{REF})^2 r \sin^2 \theta
 \end{aligned} \tag{4.52}$$

In analogy the derivatives of the normal potential can be computed.

$$\begin{aligned}
 -\frac{\partial U}{\partial x} &= \frac{\partial U}{r \partial \theta} = \frac{GM^{REF}}{ra^{REF}} \sum_{n=2(2)}^8 \left(\frac{a^{REF}}{r} \right)^{n+1} \bar{C}_n^{REF} \frac{\partial \bar{P}_n(\cos \theta)}{\partial \theta} + (\omega^{REF})^2 r \sin \theta \cos \theta \\
 -\frac{\partial U}{\partial y} &= \frac{\partial U}{r \sin \theta \partial \lambda} = 0 \\
 \frac{\partial U}{\partial z} &= \frac{\partial U}{\partial r} = -\frac{GM^{REF}}{ra^{REF}} \sum_{n=0(2)}^8 (n+1) \left(\frac{a^{REF}}{r} \right)^{n+1} \bar{C}_n^{REF} \bar{P}_n(\cos \theta) + (\omega^{REF})^2 r \sin^2 \theta
 \end{aligned} \tag{4.53}$$

The deflection of the vertical for a point on the Earth surface is defined as the angle between the real plumb line direction and the ellipsoidal normal vector. The two components of the deflection of the vertical are computed by the following formulas (see Heiskanen / Moritz, 1967, p. 83, equation 2-140):

$$\xi = \Phi - \varphi' ; \quad \eta = (\Lambda - \lambda) \cos \varphi' \tag{4.54}$$

where ξ North-South deflection of the vertical at computation point positive towards North
 η East-West deflection of the vertical at computation point positive towards East
 Φ, Λ Astronomical coordinates representing the real plumb line
 φ', λ Ellipsoidal coordinates representing the ellipsoid normal

The astronomical coordinates are related to the gravity potential at the surface of the Earth by the relations (4.55) and (4.56) (see Heiskanen / Moritz, 1967, p. 57, equation 2.29). These relations are applicable to derivatives of the gravity and normal potential in geocentric rectangular system (X parallel to Greenwich meridian plane, Y orthogonal to X in equatorial plane, Z orthogonal to equatorial plane pointing North).

		<p><i>GOCE Level 2 Product Data Handbook</i> Doc. Nr: GO-MA-HPF-GS-0110 Issue: 5.0 Date: 04.08.2014 Page: 41 of 84</p>
---	---	--

$$\Phi = \arctan \left(\frac{-\frac{\partial W}{\partial Z}}{\sqrt{\left(\frac{\partial W}{\partial X}\right)^2 + \left(\frac{\partial W}{\partial Y}\right)^2}} \right); \Lambda = \arctan \left(\frac{\frac{\partial W}{\partial Y}}{\frac{\partial W}{\partial X}} \right) \quad (4.55)$$

In analogy the ellipsoidal coordinates are related to the normal potential by the following formulas:

$$\phi' = \arctan \left(\frac{-\frac{\partial U}{\partial Z}}{\sqrt{\left(\frac{\partial U}{\partial X}\right)^2 + \left(\frac{\partial U}{\partial Y}\right)^2}} \right) \quad (4.56)$$

In order to apply (4.55) and (4.56) the derivatives of the actual and normal gravity potential computed with equations (4.52) and (4.53) have to be transformed from the local orthogonal right handed coordinate system introduced above (x positive towards the North, y positive towards the West, z: from geocenter to local origin pointing radially outward) to the geocentric rectangular system applying the following equation (applying the 3-D rotational matrix $R_3(-\lambda)R_2(-\theta)R_3(\pi)$).

$$\begin{bmatrix} \frac{\partial W}{\partial X} \\ \frac{\partial W}{\partial Y} \\ \frac{\partial W}{\partial Z} \end{bmatrix} = \begin{bmatrix} -\sin \varphi \cos \lambda & \sin \lambda & \cos \varphi \cos \lambda \\ -\sin \varphi \sin \lambda & -\cos \lambda & \cos \varphi \sin \lambda \\ \cos \varphi & 0 & \sin \varphi \end{bmatrix} \cdot \begin{bmatrix} \frac{\partial W}{\partial x} \\ \frac{\partial W}{\partial y} \\ \frac{\partial W}{\partial z} \end{bmatrix} \quad (4.57)$$

$$\begin{bmatrix} \frac{\partial U}{\partial X} \\ \frac{\partial U}{\partial Y} \\ \frac{\partial U}{\partial Z} \end{bmatrix} = \begin{bmatrix} -\sin \varphi \cos \lambda & \sin \lambda & \cos \varphi \cos \lambda \\ -\sin \varphi \sin \lambda & -\cos \lambda & \cos \varphi \sin \lambda \\ \cos \varphi & 0 & \sin \varphi \end{bmatrix} \cdot \begin{bmatrix} \frac{\partial U}{\partial x} \\ \frac{\partial U}{\partial y} \\ \frac{\partial U}{\partial z} \end{bmatrix} \quad (4.58)$$

The derivatives of the actual potential and the normal gravity potential are computed by equations (4.52) and (4.53). After applying the transformations with equations (4.57) and (4.58) and solving equations (4.55) and (4.56), finally the deflections of the vertical are computed by equations (4.54).

5. LEVEL-2 PRODUCT DEFINITIONS

5.1 PRODUCT IDENTIFIER

The product file names within the GOCE project follow the Earth Explorer standard [AD-9]. Each product file name is composed of the following components:

MM_CCCC_TTTTTTTTTT_yyyymmddThhmmss_YYYYMMDDTHHMMSS_vvvv.XXX

The meaning of these components is:

MM	Mission identifier: GO for GOCE
CCCC	File class: CONS for final products
TTTTTTTTTT	File type (see Table 4-3): e.g. EGG_NOM_2_, EGM_GOC_2_, SST_PSO_2_
vvvv	Version number
xxx	File extension: e.g. HDR for XML header file, DBL for XML data block
yyymmddThhmmss	Product validity start time in year, month, day and time in hours, minutes, seconds [UTC]
YYYYMMDDTHHMMSS	Product validity stop time in year, month, day and time in hours, minutes, seconds [UTC]

		<p><i>GOCE Level 2 Product Data Handbook</i> Doc. Nr: GO-MA-HPF-GS-0110 Issue: 5.0 Date: 04.08.2014 Page: 43 of 84</p>
---	---	--

5.2 PRODUCT DESCRIPTIONS

5.2.1 EGG_NOM_2_

Calibrated and corrected gravity gradients in the GRF are provided in daily files in the product EGG_NOM_2_ with a latency of 2 weeks. These gravity gradients (GG) are a level 2 product by themselves and they are used in the gravity field analysis to produce EGM_GOC_2_ (see below). They are also provided in a Local North Oriented Frame in the product EGG_TRF_2_ (see below). A summary of EGG_NOM_2_ is given in the table below.

Input

As input for EGG_NOM_2_ the internally calibrated GOCE GG are used (EGG_NOM_1b) as well as the GRF to IRF attitude quaternions (EGG_IAQ_1b) and the reduced dynamic precise science orbit SST_PSO_2, which also includes the EFRF to IRF quaternions. In addition, a state-of-the-art priori global gravity field model is used.

Output

The EGG_NOM_2_ product contains gravity gradients in the GRF with corrections for temporal gravity variations and validated against external gravity data. In addition, potential outliers are flagged and data gaps are filled in.

The temporal corrections are provided for the following effects: direct tide, Earth tide, ocean tide, pole tide and non-tidal gravity field variations. They are provided at each epoch for all 6 GG (gravity gradient) components.

Furthermore data screening is applied which:

- Detects and flags potential outliers and data gaps.
- Provides a fill-in value in case of a data gap if the data gap lasts less than 5 consecutive seconds.

Moreover a validation against external gravity data is performed which:

- Calculates calibration parameters, that is, scale factors between the internal calibrated, temporal corrected GGs free of outliers and modeled GGs derived from a state-of-the-art gravity field model.
- Determines if the calibration parameters should be applied to the GGs.

Flags in the EGG_NOM_2_ product indicate whether temporal corrections and/or external calibration were applied and whether outliers or data gaps were flagged and filled in. The flags are given in columns 14 to 19 and have the following meaning:

Flag 0: Original Level 1b GGs

The original Level 1b gravity gradients are given and all columns with corrections contain zeros. In the nominal situation this does not occur.

Flag 1: GGs with temporal corrections applied and validated with external gravity data

- Temporal gravity variations : Temporal corrections have been applied to the Level 1b GGs.
- Data screening : The data screening was performed but did not detect the epoch as an outlier nor a data gap.
- External calibration : The GGs corrected for temporal gravity have been calibrated with external gravity data, but the calibration corrections were not applied.
- Provided gravity gradients : Columns 2 to 7 contain the temporal corrected GGs.
- Temporal corrections : The temporal corrections, defined as the temporal corrected GGs subtracted from Level 1b GGs, are given in columns 20 to 49 for each of the 6 GG components.
- External calibration corrections : The calibration corrections columns, from 50 to 55, are filled with "0.0000".

Flag 2: GG with temporal corrections applied and external validation performed and calibration parameters applied

- Temporal gravity variations : Temporal corrections have been applied to the Level 1b GGs.
- Data screening : The data screening was performed but did not detect the epoch as an outlier nor a data gap.
- External calibration : The GGs corrected for temporal gravity have been calibrated with external gravity data. And the calibration corrections were applied.
- Provided gravity gradients : Columns 2 to 7 contain the temporal corrected, external calibrated GGs.
- Temporal corrections : The temporal corrections, defined as the temporal corrected GG subtracted from Level 1b GGs, are given in columns 20 to 49 for each of the 6 GG components.
- External calibration corrections : The calibration corrections, defined as the temporal corrected, external calibrated GGs subtracted from the temporal corrected GGs, are given in columns 50 to 55 for each of the 6 GG components.

Flag 3: GG with temporal corrections, external validation performed, outlier suspected and fill-in value provided

- Temporal gravity variations : Temporal corrections have been applied to the Level 1b GGs.
- Data screening : The data screening was performed and suspected the epoch to be an outlier. A fill-in value, which is determined by a cubic spline interpolation of the temporal corrected GG data at neighboring epochs, is provided (columns 2 to 7). The interpolation corrections issued from the data screening are not provided.
- External calibration : The GGs corrected for temporal gravity have been validated with external gravity data. The external calibration corrections may have been applied or not. The user must consult the calibration correction columns (50 to 55) to know if the calibration corrections were applied or not. If the latter are filled with “0.000” then the calibration corrections were not applied. Otherwise they were.
- Provided gravity gradients : Columns 2 to 7 contain the fill-in value of the temporal corrected GGs, with or without external calibration corrections, according to the value in the external calibration columns, 50 to 55.
- Temporal corrections : The temporal corrections, defined as the temporal corrected GG subtracted from Level 1b GGs, are given in columns 20 to 49 for each of the 6 GG components.
- External calibration corrections : The calibration corrections, defined as the temporal corrected, external calibrated GGs subtracted from the temporal corrected GGs, are given in columns 50 to 55 for each of the 6 GG components if the external calibration corrections were applied. Otherwise these columns are filled with “0.0000”.

Flag 4: GG with temporal corrections applied, external calibration performed, outlier suspected, fill-in value not provided

- Temporal gravity variations : Temporal corrections have been applied to the Level 1b GGs.
 - Data screening : The data screening was performed and suspected the epoch to be an outlier. But no fill-in value is provided.
 - External calibration : The GGs corrected for temporal gravity have been validated with external gravity data. The external calibration corrections may have been applied or not. The user must consult the calibration correction columns (50 to 55) to know if the calibration corrections were applied or not. If the latter are filled with “0.000” then the calibration corrections were not applied. Otherwise they were.
 - Provided gravity gradients : Columns 2 to 7 contain the temporal corrected GGs, with or without external calibration corrections, according to the value in the external calibration columns, 50 to 55.
 - Temporal corrections : The temporal corrections, defined as the temporal corrected GG subtracted from Level 1b GGs, are given in columns 20 to 49 for each of the 6 GG components.
 - External calibration corrections : The calibration corrections, defined as the temporal corrected, external calibrated GGs subtracted from the temporal corrected GGs, are given in columns 50 to 55 for each of the 6 GG components.
-

		<p><i>GOCE Level 2 Product Data Handbook</i> Doc. Nr: GO-MA-HPF-GS-0110 Issue: 5.0 Date: 04.08.2014 Page: 46 of 84</p>
--	---	--

Flag 5: GG with temporal corrections applied, external calibration performed, data gap suspected, fill-in value provided

This flag points out that at this epoch the Level 1b GG was missing, and a fill-in value is provided. The processing and the output for such an epoch is the same as for detected outliers with a fill-in value provided. Please see flag 3.

Flag 6: GG with temporal corrections applied, external calibration performed, data gap suspected but no fill-in value provided

This flag points out that at this epoch the Level 1b GG was missing, but that no fill-in value is provided for this epoch. The reason is that the gap was longer than 5 consecutive seconds. The processing and the output for such an epoch is the same as for outliers detected but no fill-in value provided. Please see flag 4.

Remarks

Outlier detection

The definition of what is an outlier and what not may be problematic. In addition, the optimal way to provide a fill-in value may differ from user to user. It was therefore decided not to provide fill-ins anymore for outliers. All EGG_NOM_2_ products produced after November 2010 will not contain a Flag 3. Suspected outliers remain to be flagged, but will be flagged with a 4.

Data gaps

Fill-in values are provided for data gaps shorter than 5 consecutive epochs.

External calibration

Originally the calibration parameters were applied if the GG trace would improve after external calibration. Due to the high quality of the in-flight calibration gravity gradients, it was decided not to apply the external calibration corrections in the current external calibration process. However the test on the trace is still performed and provides a warning that goes to ESA via the HPF.

How to apply corrections?

Due to the definition of each correction, one must **add** these latter to the provided GGs in columns 2 to 7 to recover the previous step of the process. As an example, if one wants to recover the XX component of the original Level 1b GG for an epoch flagged with a “flag 1”, the corrections in columns 20, 26, 32, 38 and 44 must be added to the GG in columns 2. That is:

$$V_{xx} \text{ Level 1b} = V_{xx} \text{ EGG_NOM_2_}(\text{column 2}) + \text{column 20} + \text{column 26} + \text{column 32} + \text{column 38} + \text{column 44}$$

Algorithm

- First, temporal corrections are computed for all GGs.
 - Then outliers and data gaps are searched for and flagged if detected.
-

- Next, gravity gradient calibration parameters (scale factors) are determined using global gravity field models and the GG error is assessed. A validation test checks if the GG trace ($V_{XX} + V_{YY} + V_{ZZ}$) in the MBW is smaller after external calibration than before and provide a warning if so.
- In case of a data gap shorter than 5 consecutive epochs fill-in values are provided for these epochs.
- In addition, the GG calibration is validated using GOCE SST data and terrestrial gravity data.

Summary Table

Product Name	EGG_NOM_2_
Product Description	Gravity Gradients in the Gradiometer Reference Frame (GRF) (see 4.4.1) corrected for temporal gravity field variations. Outliers and data gaps are identified and external calibration is performed.
Representation	Time series
Reference Frame	GRF (HPF GOCE standards apply, see chapter 4.4.1)
Time System	GPS time (HPF GOCE standards apply, see chapter 4.4.1)
Spatial Coverage	N/A
Temporal Coverage	1 day
Spatial Resolution	≈ 8 km along-track
Temporal Resolution	1 s
Input Data	<ol style="list-style-type: none"> 1. Internally calibrated gravity gradients from the PDS (EGG_NOM_1b product) 2. GRF to IRF rotation matrix (from EGG_NOM_1b, EGG_IAQ_1b measurement data set) 3. GOCE precise science orbit & EFRF to IRF rotation matrix (SST_PSO_2_) 4. Spherical harmonic series for temporal corrections (SST_AUX_2_) 5. A priori gravity gradient error model 6. A priori gravity field model which is used in the outlier detection and the external calibration (external) 7. Indirectly: GOCE SST, terrestrial gravity data
Output Data	<ol style="list-style-type: none"> 1. Externally calibrated gravity gradients in GRF 2. Corrections to gravity gradients due to temporal gravity field variations 3. Flags for outliers, fill-in gravity gradients for data gaps with flags 4. Gravity gradient error estimates 5. Gravity gradient external calibration corrections 6. Inertial attitude quaternions from L1B product EGG_NOM_1B (EGG_IAQ).
Units	S.I. (1/s ² for the gravity gradients and the corrections)
Data Format	See chapter 5.3
Latency	2 weeks
Volume	230 MB uncompressed, 22 MB compressed

		<p><i>GOCE Level 2 Product Data Handbook</i> Doc. Nr: GO-MA-HPF-GS-0110 Issue: 5.0 Date: 04.08.2014 Page: 48 of 84</p>
---	---	--

5.2.2 EGG_TRF_2_

Calibrated gravity gradients in the LNOF are provided in monthly files in the product EGG_TRF_2_ with a latency of 1 month after each MOP. A summary of EGG_TRF_2_ is given in the table below.

Input

As input for EGG_TRF_2_ the externally calibrated GOCE GG are used (EGG_NOM_2_) as well as the GRF to IRF attitude quaternions (EGG_IAQ_1b) and the reduced dynamic precise science orbit SST_PSO_2_, which also includes the EFRF to IRF quaternions, is used. In addition, a state-of-the-art a priori global gravity field model and a GOCE QL global gravity field model is used.

Output

The product EGG_TRF_2_ consists of calibrated gravity gradients in the LNOF. Besides the gravity gradients, GG error estimates are given and flags for data expected to be an outlier or when a data gap has been filled by interpolation. The GPS time of each epoch as well as the geocentric coordinates (latitude, longitude, r) are also given.

The flags in the data records have the following meaning:

0. Original GGs rotated;
1. As 0. with temporal corrections added;
2. As 1., externally calibrated GGs;
3. Outlier suspected, fill-in provided;
4. Outlier suspected, no fill in; Value is calibrated original value;
5. Data gap, fill-in provided;
6. Data gap, no fill-in.

In the nominal case, the flag is 2 for each GG.

Algorithm

The gravity gradients in the LNOF are obtained by a direct point-wise rotation. However, 4 of the GOCE gravity gradients have high accuracy in the MBW, whereas the other 2 are less accurate. A direct point-wise rotation without any additional processing would project the larger error of the less accurate GGs into the accurate GGs in the LNOF, which is undesirable. The GOCE Γ_{xy} and Γ_{yz} gradients are therefore not used but replaced by GGs computed from a GOCE QL gravity field model. Furthermore, the $1/f$ error of the GOCE GGs, that is, the increasing error for long wavelengths, may leak into the MBW due to the point-wise rotation. In order to prevent this leakage, all six gravity gradients (4 directly from GOCE and 2 from a GOCE QL model) are high-pass filtered such that the signal in and above the MBW is kept. The GG signal below the MBW is replaced by model GG using a state-of-the-art a priori global gravity model which is expected to be accurate at long wavelengths. In short, the algorithm is as follows:

- Compute model GG components Γ_{xy} and Γ_{yz} using a GOCE QL gravity field model.
- High-pass filter the four accurate GOCE GGs (EGG_NOM_2_) and the two model GGs.

		<i>GOCE Level 2 Product Data Handbook</i> Doc. Nr: GO-MA-HPF-GS-0110 Issue: 5.0 Date: 04.08.2014 Page: 49 of 84
--	---	---

- Replace the signal below the MBW with GG signal from a state-of-the-art gravity field model.
- Rotate from GRF to LNOF.

Note

The EGG_TRF_2_ gravity gradients should be used for local applications. Because of the use of (external) gravity field models to compute the long wavelength part of these gravity gradients, they should not be used for global gravity field analysis. Or at least the results from such an analysis should be interpreted with care.

Summary Table

Product Name	EGG_TRF_2_
Product Description	Gravity Gradients in Local North-Oriented reference Frame (LNOF) (see chapter 4.4.1) corrected for temporal gravity field variations. Outliers and data gaps are identified and external calibration is applied.
Representation	Time series
Reference Frame	LNOF: Local north-oriented reference frame (HPF GOCE standards apply, see chapter 4.4.1)
Time System	GPS time (HPF GOCE standards apply)
Spatial Coverage	Global coverage without polar caps (depends on inclination of GOCE orbit)
Temporal Coverage	1 month
Spatial Resolution	≈ 8 km along-track
Temporal Resolution	1 s
Input Data	<ol style="list-style-type: none"> 1. GRF to IRF rotation matrix (EGG_IAQ_1b) 2. Externally calibrated gravity gradients in GRF (EGG_NOM_2_) 3. GOCE precise science orbit & EFRF to IRF rotation matrix (SST_PSO_2_) 4. GOCE QL gravity field model. 5. A priori gravity field model.
Output Data	<ol style="list-style-type: none"> 1. Externally calibrated gravity gradients in LNOF 2. Geocentric coordinates (latitude, longitude, radial distance) 3. Flags for outliers, fill-in gravity gradients for data gaps with flags 4. Gravity gradient error estimates
Units	S.I. ($1/s^2$ for the gravity gradients)
Data Format	See chapter 5.3
Latency	1 month
Volume	2.3 GB uncompressed, 140 MB compressed

		<p><i>GOCE Level 2 Product Data Handbook</i></p> <p>Doc. Nr: GO-MA-HPF-GS-0110</p> <p>Issue: 5.0</p> <p>Date: 04.08.2014</p> <p>Page: 50 of 84</p>
---	---	--

5.2.3 GRD_SPW_2_

Gravity gradient grids at satellite altitude from the space-wise approach. All six gravity gradients are computed only from GOCE data for the available time span (as indicated in the product) and provided on a 0.2 degree grid.

Input

As input the externally calibrated GOCE GG are used (EGG_NOM_2_) as well as the GRF to IRF attitude quaternions (EGG_IAQ_1b) and the precise science orbit SST_PSO_2, which also includes the EFRF to IRF quaternions. A state-of-the-art a priori global gravity field model is used for covariance modelling. Finally several ancillary products are used as input.

Output

The product GRD_SPW_2_ consists of calibrated gravity gradients at satellite altitude at grid point locations. Besides the gravity gradients also error estimates are given.

Algorithm

- An SST model is derived by first estimating the along track gravitational potential by applying the energy conservation approach to kinematic orbits. Then a spherical grid of potential values is computed at mean satellite altitude by local collocation and the spherical harmonic coefficients are derived by numerical integration from the grid values.
- SGG data are reduced by the SST model and processed by applying a time-wise filter to reduce the strongly time correlated noise of the gradiometer and a space-wise local collocation to estimate spherical grids of gravity gradients at mean satellite altitude. The whole procedure is iterated by using the spherical harmonic coefficients derived from the estimated grids in order to recover the signal frequencies cancelled out by the time-wise filter and to improve the rotation from gradiometer to local orbital reference frames.
- Error estimates are based on Monte Carlo simulations.

		<p><i>GOCE Level 2 Product Data Handbook</i> Doc. Nr: GO-MA-HPF-GS-0110 Issue: 5.0 Date: 04.08.2014 Page: 51 of 84</p>
--	---	--

Summary Table

Product Name	GRD_SPW_2_
Product Description	Gravity Gradients grid at satellite altitude from space-wise approach.
Representation	Grid
Reference Frame	EFRF
Time System	n/a
Spatial Coverage	Global coverage
Temporal Coverage	Indicated data span of GOCE
Spatial Resolution	0.2 degree in latitude and longitude direction
Temporal Resolution	n/a
Input Data	<ol style="list-style-type: none"> 1. GRF to IRF rotation matrix (EGG_IAQ_1b) 2. Externally calibrated gravity gradients in GRF (EGG_NOM_2_) 3. GOCE precise science orbit & EFRF to IRF rotation matrix (SST_PSO_2_) 4. Ancillary data (tide model, ephemeris, Earth rotation parameters) 5. A priori gravity field model for signal covariance modelling
Output Data	Gravity gradients and estimated errors at satellite altitude for a global grid (East-East, East-North, East-Radial, North-North, North-Radial, Radial-Radial)
Units	Eötvös ($10^{-9}/s^2$) for the gravity gradients
Data Format	See chapter 5.5
Latency	1 year
Volume	300 MB uncompressed

		<p><i>GOCE Level 2 Product Data Handbook</i> Doc. Nr: GO-MA-HPF-GS-0110 Issue: 5.0 Date: 04.08.2014 Page: 52 of 84</p>
---	---	--

5.2.4 GRC_SPW_2_

Combined data grids at ground level (10 km). Gravity anomalies and radial gravity gradients are computed from GOCE data, a GRACE global model and airborne/ground gravity data over polar areas for the available time span (as indicated in the product) and provided on a 1/6 degree grid.

Input

As input the externally calibrated GOCE GG are used (EGG_NOM_2_) as well as the GRF to IRF attitude quaternions (EGG_IAQ_1b) and the precise science orbit SST_PSO_2, which also includes the EFRF to IRF quaternions. In addition, a state-of-the-art a priori global gravity field model including GRACE data, terrestrial and airborne gravity data over polar areas and several ancillary products are used as input.

Output

The product GRC_SPW_2_ consists of gravity anomalies and radial gravity gradients at ground level (10 km altitude) at the grid point locations. Besides the gravity anomalies and gravity gradients also error estimates are given.

Algorithm

- Remove from GOCE and external gravity data the contribution of a GRACE model.
- Divide data into equal-area patches of 24°x 24° with a 2° overlap.
- Compute empirical covariance functions by EMPCOV and determine an analytic representation by COVFIT.
- Compute grid values and error estimates of the output functionals by least squares collocation using GEOCOL with a resolution of 1/6 degree at an altitude of 10 km.

		<p><i>GOCE Level 2 Product Data Handbook</i> Doc. Nr: GO-MA-HPF-GS-0110 Issue: 5.0 Date: 04.08.2014 Page: 53 of 84</p>
--	---	--

Summary Table

Product Name	GRC_SPW_2_
Product Description	Gravity Anomalies and radial Gravity Gradients grid at 10 km altitude from space-wise approach.
Representation	Grid
Reference Frame	EFRF
Time System	n/a
Spatial Coverage	Global coverage
Temporal Coverage	Indicated data span of GOCE
Spatial Resolution	1/6 degree in latitude and longitude direction
Temporal Resolution	n/a
Input Data	<ol style="list-style-type: none"> 1. GRF to IRF rotation matrix (EGG_IAQ_1b) 2. Externally calibrated gravity gradients in GRF (EGG_NOM_2_) 3. GOCE precise science orbit & EFRF to IRF rotation matrix (SST_PSO_2_) 4. Ancillary data (tide model, ephemeris, Earth rotation parameters) 5. A priori gravity field model including GRACE data 6. Terrestrial and airborne gravity data mainly over polar areas
Output Data	Gravity anomalies and radial gravity gradients and estimated errors at ground level (10 km) for a global grid .
Units	mgal (10^{-5} m/s^2) for gravity anomalies, Eötvös for gravity gradients ($10^{-9}/\text{s}^2$ for the gravity gradients)
Data Format	See chapter 5.5
Latency	1 year
Volume	200 MB uncompressed

		<p><i>GOCE Level 2 Product Data Handbook</i> Doc. Nr: GO-MA-HPF-GS-0110 Issue: 5.0 Date: 04.08.2014 Page: 54 of 84</p>
---	---	--

5.2.5 SST_PSO_2_

The SST_PSO_2_-product consists of two different orbits (reduced-dynamic and kinematic) in the EFRF. They are generated using a tailored HPF version of the Bernese GPS Software (see Dach et al., 2007). The determination of both orbit solutions is realized in one processing scheme using undifferenced dual-frequency carrier phase observations from the on-board GPS receiver. The GPS orbit and Earth orientation parameter information is taken from the final orbit solution of the CODE (Center for Orbit Determination in Europe, located at AIUB) analysis center of the IGS. The high-rate GPS clock corrections (5 sec) are based on the CODE final clock solution (30 sec) and are generated in a separate procedure within the HPF. Both orbit solutions are based on the same set of screened carrier phase observations.

The daily reduced-dynamic orbit solution (10 sec sampling) is parameterized as follows:

- six initial osculating elements,
- three constant empirical accelerations in radial, along-track, and cross-track direction, and
- additional (constrained) piece-wise constant accelerations over six minutes in radial, along-track, and cross-track direction.

The kinematic orbit solution (1 sec sampling) is represented by unconstrained position estimates for each observation epoch. The variance-covariance information for the position estimates is included for a moving window covering nine consecutive epochs.

In order to support the use of the orbit solutions in the IRF, a rotation matrix between the EFRF and the IRF is included into the PSO product.

Finally, the quality report gives information about the accuracy of the PSO solutions. It also includes an independent quality assessment of the orbits using the SLR measurements to the GOCE satellite as well as a comparison with independently derived quick-look orbit solutions, referred to as Rapid Science orbits (RSO).

More details about the generation of the SST_PSO_2_ can be found in (Bock et al., 2007) and (Visser et al., 2006).

		<p><i>GOCE Level 2 Product Data Handbook</i> Doc. Nr: GO-MA-HPF-GS-0110 Issue: 5.0 Date: 04.08.2014 Page: 55 of 84</p>
--	---	--

Summary Table

Product Name	SST_PSO_2_
Product Description	Precise science orbits from reduced-dynamic approach (positions and velocities) and kinematic approach (positions), both in EFRF (see section 4.4.1). Additionally included is variance-covariance information for the kinematic orbits (a moving window is used for the covariances with a length of 9 consecutive epochs) and the rotation matrix for each epoch from the EFRF to the IRF in terms of quaternions according to section 4.4.2.1. Furthermore a quality report based on the daily orbit solutions is included in the product.
Representation	Orbits, variance-covariance matrices and rotation matrices are provided as time series, the quality report in PDF format.
Reference Frame	EFRF
Time System	GPS time
Reference System	Not applicable
Spatial Coverage	Global along satellite tracks
Temporal Coverage	1 day
Spatial Resolution	Not applicable
Temporal Resolution	1 sec
Input Data	GPS data; ancillary data from several sources (e.g. Earth rotation parameters)
Output Data	Several sub-product files to be combined to one product
Units	Positions [m], velocities [m/s], rotation angles [dimensionless]
Data Format	See chapter 5.3
Latency	4 weeks
Volume	480 MB uncompressed, 21 MB compressed

		<p><i>GOCE Level 2 Product Data Handbook</i> Doc. Nr: GO-MA-HPF-GS-0110 Issue: 5.0 Date: 04.08.2014 Page: 56 of 84</p>
--	---	--

5.2.6 EGM_GOC_2_

The EGM_GOC_2 products contain GOCE gravity field solutions in different representations. The elementary sub-product is a spherical harmonic series of the gravitational potential of the Earth up to a specific degree and order (EGM_GCF_2_). These coefficients and their standard deviations (computed from error variances) are estimated from GOCE SSTI and gradiometer observations taken within a specific period. For each measurement operational phase (MOP) as well as for the complete mission data set one gravity field model is computed.

The coefficients data set is accompanied by several derived gravity field quantities. These are geoid heights, gravity anomalies and deflections of the vertical. All sub-products are provided on equi-angular grids with a spatial resolution of 30'x30' within the coverage of the GOCE orbit ($\pm 83^\circ$ latitude). They are computed by spherical harmonic synthesis from the complete series and refer to the chosen reference ellipsoid as specified in [AD-12] (see chapter 4.4.3 for formulas and their application). In order to avoid any dependency on external surface elevation data sets, which often have significant uncertainties, all derived quantities are computed by applying the approximations as explained in chapter 4.4.3.1. For highest accuracy requirements a precise digital elevation model for the computation area is required and the formulas as described in chapter 4.4.3.2 have to be applied. In this case the provided grids of derived gravity field quantities shall not be used and all computations shall start from the set of spherical harmonic coefficients.

For quality analysis of the gravity field solution additional information is provided. Standard deviations for the spherical harmonic coefficients are provided together with the series. Further-on the full variance co-variance matrix is provided in a separate product (see chapter 5.2.7). By full error propagation geoid height errors (standard deviations) are computed from the coefficient variance co-variance matrix. These errors are provided on the same grid as the derived gravity field quantities as described above. Finally, in order to assess the overall internal and external quality of the model a quality report is attached to the product. This report contains results of comparisons to independently derived gravity field models (from various data and missions) as well as to in-situ observations of gravity field quantities.

		<p><i>GOCE Level 2 Product Data Handbook</i> Doc. Nr: GO-MA-HPF-GS-0110 Issue: 5.0 Date: 04.08.2014 Page: 57 of 84</p>
---	---	--

Summary Table

Product Name	EGM_GOC_2_
Product Description	<p>GOCE gravity field model: The coefficients of the spherical harmonic series of the gravitational potential are provided as defined in equation (4.18) (sub-product EGM_GCF_2_). As derived quantities grids of geoid heights, gravity anomalies and deflections of the vertical are additionally included in the product. These quantities are defined as follows: Geoid heights are defined in equation (4.35) (sub-product EGM_GEO_2_). Gravity anomalies are defined in equation (4.38) (sub-product EGM_GAN_2_). Deflections of the vertical are defined in equations (4.40) and (4.41) (sub-products EGM_GVE_2_ and EGM_GVN_2_). Errors are provided as variances and covariances of the coefficients of the spherical harmonic series of the gravitational potential. Variances are included in the spherical harmonic series while the full variance-covariance matrix is provided in product EGM_GVC_2. The full variance-covariance matrix of the coefficients is propagated to geoid height errors on a grid applying equation (4.20) (sub-product EGM_GER_2_). Further-on a quality report based on an extensive product validation is included in the product (sub-product EGM_GRP_2_).</p>
Representation	The gravity field is provided as spherical harmonic series up to a specific degree and order. Derived quantities are provided on equi-angular grids. The quality report is provided in PDF format.
Reference Frame	EFRF
Time System	Not applicable
Reference System	GRS80 reference ellipsoid for geoid heights (and errors), gravity anomalies and deflections of the vertical.
Spatial Coverage	Spherical harmonic series: global by definition Grids in the area $\pm 83^\circ$ latitude: limited by GOCE inclination ($96,7^\circ$).
Temporal Coverage	At least 1 measurement operational phase. It is planned to release one GOCE gravity field model for each measurement operational phase and the final model based on all GOCE data.
Spatial Resolution	Spherical harmonic series are provided up to a maximum degree and order, which depends on the data coverage (approximately degree and order 250). Derived quantities are provided as point values on 30'x30' equi-angular grids.
Temporal Resolution	Not applicable
Input Data	GOCE gradiometer and GPS data; Ancillary data from different sources.
Output Data	Several sub-product files to be combined to one product
Units	Spherical harmonic coefficients are dimensionless, Geoid heights and standard deviations in [m], gravity anomalies in [m/s^2], deflections of the vertical in [arc sec].
Data Format	See chapter 5.3
Latency	6 months after completion of each measurement operational phase
Volume	144 MB uncompressed, 33 MB compressed

5.2.7 EGM_GVC_2_

The GOCE gravity field models (EGM_GOC_2_) are estimated by an adjustment process. Apart from the solution the full variance-co-variance matrix is estimated within this process. This matrix on one hand provides the error variances of the estimated coefficients of the spherical harmonic series and on the other hand it also provides the co-variances (or correlations) between the estimated coefficients. By further analyzing and processing this matrix a complete error analysis for the GOCE gravity field models can be performed. It shall be noted that the error variances and co-variances represent an internal error measure, which can not always be regarded as a realistic absolute error. But, during computation of the GOCE gravity field models it will be taken care that the provided errors are at least close to realistic absolute errors. As GOCE provides completely new information in the mid frequency range of the gravity field also comparisons to independent gravity field observations cannot provide a full picture of the absolute errors of the GOCE gravity field solutions. Such analyses are provided in the quality report of the EGM_GOC_2_ product (see chapter 5.2.6).

Summary Table

Product Name	EGM_GVC_2_
Product Description	Variance-covariance matrix for the coefficients of the spherical harmonic series of the GOCE gravity field model EGM_GOC_2_. The product contains the full variance and covariance information for the model.
Representation	The matrix is provided for the complete spherical harmonic series.
Reference Frame	EFRF
Time System	Not applicable
Reference System	Not applicable
Spatial Coverage	Spherical harmonic series: global by definition
Temporal Coverage	At least 1 measurement operational phase. The variance-covariance matrix is released each time a new GOCE gravity field product is finalized.
Spatial Resolution	Variance-co-variance matrix is provided up to a maximum degree and order, which depends on the EGM_GOC_2_ product..
Temporal Resolution	Not applicable
Input Data	GOCE gradiometer and GPS data; ancillary data from different sources.
Output Data	Full variance-covariance matrix
Units	Variances and co-variances of spherical harmonic coefficients are dimensionless.
Data Format	See chapter 5.4
Latency	6 months after completion of each measurement operational phase
Volume	Several GB

		<p><i>GOCE Level 2 Product Data Handbook</i> Doc. Nr: GO-MA-HPF-GS-0110 Issue: 5.0 Date: 04.08.2014 Page: 59 of 84</p>
---	---	--

5.2.8 SST_AUX_2_

The goal of the GOCE mission is to determine the static part of the Earth gravity field. Due to the space time sampling of the GOCE orbits time variable mass variations in the system Earth have to be taken into account during data analysis in order to eliminate them. For the final GOCE gravity field solutions (EGM_GOC_2_) the complete set of tidal and non-tidal variations is taken into account. For tidal effects the models as specified in [AD-12] are applied in data analysis and are provided as corrections to the gravity gradients (see EGG_NOM_2_ in chapter 5.2.1). For non-tidal effects atmospheric, oceanic and remaining long wavelength annual mass variations are considered. They are computed from atmospheric data from the ECMWF operational analysis, from bottom pressure estimates from the OMCT model (Thomas, 2002) and from a GRACE monthly gravity field time series.

6-hourly atmospheric mass variations are estimated from surface pressure and 3-D temperature and specific humidity fields all referenced to a long-term mean field, which represents the static atmosphere contribution. The ocean model is driven by atmospheric parameters from the same model and provides 6-hourly estimates of ocean bottom pressure also referenced to a long-term mean field. Both sets are combined over the oceans and a spherical harmonic analysis is performed, such that residual gravity field spherical harmonic series are computed. Finally, from the GRACE gravity field time series annual amplitudes and phases are estimated for the long wavelength coefficients. As the same atmospheric and oceanic mass variations are eliminated in the GRACE fields, they represent remaining mass variation effects due to hydrology, ice mass variations and others. For each 6-hourly time step the annual GRACE variations are interpolated and added to the atmosphere/ocean coefficients.

In the SST_AUX_2_ product every 6 hours a set of residual gravity potential spherical harmonic series is provided. This series can be regarded as a correction to the static gravity field. In the EGG_NOM_2_ product the non-tidal corrections for all 6 gravity gradients are computed based on these spherical harmonic series. For the analysis of the SSTI data for gravity field determination the SST_AUX_2_ product shall be used as correction.

		<p><i>GOCE Level 2 Product Data Handbook</i> Doc. Nr: GO-MA-HPF-GS-0110 Issue: 5.0 Date: 04.08.2014 Page: 60 of 84</p>
--	---	--

Summary Table

Product Name	SST_AUX_2
Product Description	Non-tidal time variable gravity field potential with respect to a mean value in terms of a spherical harmonic series determined from atmospheric and oceanic mass variations as well as from a GRACE monthly gravity field time series.
Representation	The non-tidal time variable gravity field is provided as spherical harmonic series up to a specific degree and order.
Reference Frame	EFRF
Time System	UTC
Reference System	Not applicable
Spatial Coverage	Spherical harmonic series: global by definition
Temporal Coverage	All mission operation phases.
Spatial Resolution	Spherical harmonic series are provided up to a maximum degree and order sufficient to take into account all relevant time variable signals (e.g. 100).
Temporal Resolution	6 hours
Input Data	ECMWF atmospheric model data. Ocean bottom pressure from OMCT model.
Output Data	Gravity potential spherical harmonic series
Units	Spherical harmonic coefficients are dimensionless,
Data Format	See chapter 5.3
Latency	2 weeks
Volume	1 MB

		<p><i>GOCE Level 2 Product Data Handbook</i> Doc. Nr: GO-MA-HPF-GS-0110 Issue: 5.0 Date: 04.08.2014 Page: 61 of 84</p>
---	---	--

5.3 XML PRODUCT FORMATS

This chapter contains the description of the XML format of all level 2 products that are generated by the HPF for the GOCE mission, except for the variance-covariance matrix product EGM_GVC_2. The description of the EGM_GVC_2 format is provided in chapter 5.4. The purpose of the chapter is to define the product structure and content of each level 2 product generated in the HPF identifying for each data section and field the meaning and the format to be used for its representation.

5.3.1 File Structure

The file structure of any Level 2 file produced by the HPF must follow the requirements of the [AD-9].

Each level 2 product is composed by two files:

- XML Header file, with extension “.HDR”
- XML Product file, with extension “.DBL”.

Both files are packed using tar/gzip for distribution, with extension “.TGZ”.

All Level 2 files produced by the HPF in XML format begin with the following XML declaration:

```
<?xml version="1.0" encoding="US-ASCII"?>
```

The XML Header file is an auxiliary ASCII file (in XML format) that users can easily access for identifying the product without needs to look inside the XML Product file.

The XML Product file is the real product containing meaningful instrument data or data used by ad hoc development standard tools for inspecting the product’s content.

5.3.2 XML Header File

The XML Header file contains information identifying the product and is easy to read as based on a standard syntax accessed by common tools available for visualizing its content.

The XML header file consists of:

- A fixed header
- A variable header

The Fixed Header (hereafter called Standard GOCE Header) is the common header for all files produced by the HPF. The Variable Header (hereafter called Product Header) is the header with the format and content depending on the file type and kind of product.

Standard GOCE Header (Fixed Header)

		<p><i>GOCE Level 2 Product Data Handbook</i> Doc. Nr: GO-MA-HPF-GS-0110 Issue: 5.0 Date: 04.08.2014 Page: 62 of 84</p>
---	---	--

The standard GOCE header is completely ASCII and based on XML and conventions proposed in [AD-9].

The fixed header fields are specified in the following table:

Tag Name	Type	Comment
File_Name	string	file name without extension
File_Description	string	restricted number of possible values
Notes	string	reserved for future use
Mission	string	shall always be "GOCE"
File_Class	string	
File_Type	string	
Validity_Period	structure	
+ Validity_Start	string	UTC=yyyy-mm-ddThh:mm:ss
+ Validity_Stop	string	UTC=yyyy-mm-ddThh:mm:ss
File_Version	integer	
Source	structure	
+ System	string	"GOCE High Level Processing Facility (HPF)"
+ Creator	string	"HPF's Central Processing Facility (CPF) using cpf_eef_create"
+ Creator_Version	string	version of the creator tool
+ Creation_Date	string	UTC=yyyy-mm-ddThh:mm:ss

Product Header (Variable Header)

The Product Header for level 2 products is composed by:

- a XML Main Product Header (MPH)
- a XML Specific Product Header (SPH) which includes Data Set Descriptors for reference to external input files and Measurement Data of the Product.

XML Main Product Header (MPH)

Tag Name	Type	Comment
Product	string	file name without extension
Ref_Doc	string	shall always be "GO-ID-HPF-GS-0041"
Acquisition_Station	empty	
Processor	structure	
+ Proc_Stage	character	ENUM('O','T','R','C')
+ Proc_Center	string	"HPF" for L2, else Workpackage/Institute
+ Proc_Time	string	UTC=yyyy-mm-ddThh:mm:ss
+ Software_Ver	string	Processorname/VV.rr
Time_Information	structure	
+ Sensing	structure	
++ Start	string	UTC=yyyy-mm-ddThh:mm:ss.uuuuuu Can contain a 'not applicable' (N/A) value: UTC=0000-00-00T00:00:00.000000
++ Stop	string	UTC=yyyy-mm-ddThh:mm:ss.uuuuuu Can contain a 'not applicable' (N/A) value: UTC=9999-99-99T99:99:99.999999
+ Abs_Orbit	struture	
++ Start	integer	



++ Stop	integer	
Phase	character	not used, set to 'X'
Cycle	integer	not used, set to zero
Rel_Orbit	integer	not used, set to zero
Abs_Orbit	integer	not used, set to zero
State_Vector_Time	empty	
X_Position	float	not used, set to '0.000'
Y_Position	float	not used, set to '0.000'
Z_Position	float	not used, set to '0.000'
X_Velocity	float	not used, set to '0.000000'
Y_Velocity	float	not used, set to '0.000000'
Z_Velocity	float	not used, set to '0.000000'
Vector_Source	empty	
Product_Err	integer	0: no errors; 1 errors have been reported
DBL_Size	integer	format='(013d)'
HDR_Size	integer	format='(011d)'
Num_DSD	integer	
Num_Data_Sets	integer	number of DSDs with Dta_Set_Type='O'
CRC	integer	not used, set to '-1'

XML Specific Header (SPH)

Tag Name	Type	Comment
SPH_descriptor	string	equal to File_Type (see fixed header)
Original_Source	structure	
+ Product	string	Prod. name of orig. src. in HPF format
Time_Information	structure	
+ GPS_Time	structure	
++ Start	string	format='(%20.9f)'
++ Stop	string	format='(%20.9f)'
+ Abs_Orbit	structure	
++ Start	integer	
++ Stop	integer	
<productID>	structure	(main) product identifier
<i>Product Specific tags are included here (see paragraph 5.3.2.1 till 5.3.2.5 for details)</i>		
DSDs	structure	
+ List_of_DSDs	structure	attribute: 'count'
++ Data_Set_Descriptor	structure	repeated 'count' times
+++ Data_Set_Name	string	
+++ Data_Set_Type	character	ENUM('I','O','S')
+++ File_Name	string	name of Reference File
+++ Num_Epochs	integer	
+++ MD5	string	

5.3.2.1 SPH product specific tags: EGG_NOM_2

Tag Name	Type	Comment
Original_Source	structure	
+ Format	structure	
++ Name	string	'GG_time'
++ Version	string	
Product_Type	string	"quick_look" or "final"

Input	structure	
+ L1	string	“fast“, “consolidated“, or “recomputed“
+ L2	string	“quick_look“ or “precise“
Reference_System	string	shall always be “GRF“
Tide_System	string	“zero_tide“, “tide_free“ or “unknown“
Gravity_Model	string	reference gravity model used
Errors	string	“formal“ or “calibrated“

5.3.2.2 SPH product specific tags: EGG_TRF_2

Tag Name	Type	Comment
Original_Source	structure	
+ Format	structure	
+ + Name	string	‘GG_spatial’
+ + Version	string	
Product_Type	string	shall always be “final“
Input	structure	
+ L1	string	“consolidated“, or “recomputed“
+ L2	string	shall always be “precise“
Reference_System	string	shall always be “TRF“
Tide_System	string	“zero_tide“, “tide_free“ or “unknown“
Gravity_Model	string	reference gravity model used
Errors	string	“formal“ or “calibrated“

5.3.2.3 SPH product specific tags: SST_PSO_2

Tag Name	Type	Comment
SST_PRP_2	structure	<i>sub-product</i>
+ Original_Source	structure	
+ + Format	structure	
+ + + Name	string	‘PDF’
+ + + Version	string	
SST_PKI_2	structure	<i>sub-product</i>
+ Original_Source	structure	
+ + Format	structure	
+ + + Name	string	‘Sp3c’
+ + + Version	string	
+ + + Type	character	
+ Pos_or_Vel	character	“P” or ”V”
+ Time_Information	structure	
+ + System	structure	
+ + GPS_Time	structure	
+ + + Start	structure	
+ + + + GPS	structure	
+ + + + + Week	integer	
+ + + + + Seconds_of_week	float	
+ + + + + Mod_Jul_day	structure	
+ + + + + Day	integer	
+ + + + + Fractional_Day	float	



++++ Gregorian	structure	Gregorian representation ¹
+++++ Year	integer	
+++++ Month	integer	
+++++ Day_of_Month	integer	
+++++ Hour	integer	
+++++ Minute	integer	
+++++ Second	float	
+ Epoch_Information	structure	
++ Num_Epochs	integer	
++ Interval	float	
+ Data_Used	string	
+ Coordinate_Sys	string	
+ Orbit_Type	string	
+ Agency	string	
+ List_of_Satellite_Descriptors	structure	attribute: 'count'
++ Satellite_Descriptor	structure	repeated 'count' times
+++ Satellite_ID	string	
+++ Accuracy	string	
+ Base_for_Pos_or_Vel	float	
+ Base_for_Clk_or_Rate	float	
+ Comments	string	
SST_PCV_2	structure	<i>sub-product</i>
+ Original_Source	structure	
++ System	string	
++ Creator	string	
++ Creator_Version	string	
++ Creation_Date	string	yyyy-mm-dd hh:mm:ss
++ Format	structure	
+++ Name	string	'Covariance'
+++ Version	string	
+ Var_Cov_Matrix	structure	
++ File_Name	string	
+ Corresponding_Kinematic_Orbit	structure	
++ File_Name	string	
+ Time_Information	structure	
++ System	string	
++ Time_Step_Size	integer	attribute: 'unit'
++ GPS_Time	structure	
+++ Start	structure	
++++ Gregorian	structure	Gregorian representation (see footnote 1)
+++++ Year	integer	
+++++ Month	integer	
+++++ Day_of_Month	integer	
+++++ Hour	integer	
+++++ Minute	integer	
+++++ Second	float	
+++ Stop	structure	
+ RMS_Of_Unit_Weight	float	
+ Parameters	string	
SST_PRD_2	structure	<i>sub-product</i>

¹ The tag <Gregorian> under a <GPS_Time> tag means GPS time expressed in year, month, day, hours, minutes and seconds



+ Original_Source	structure	
++ Format	structure	
+++ Name	string	'Sp3c'
+++ Version	string	
+++ Type	character	
+ Pos_or_Vel	character	
+ Time_Information	structure	
++ System	structure	
++ GPS_Time	structure	
+++ Start	structure	
++++ GPS	structure	
+++++ Week	integer	
+++++ Seconds_of_week	float	
+++++ Mod_Jul_day	structure	
+++++ Day	integer	
+++++ Fractional_Day	float	
+++++ Gregorian	structure	Gregorian representation (see footnote 1)
+++++ Year	integer	
+++++ Month	integer	
+++++ Day_of_Month	integer	
+++++ Hour	integer	
+++++ Minute	integer	
+++++ Second	float	
+ Epoch_Information	structure	
++ Num_Epochs	integer	
++ Interval	float	
+ Data_Used	string	
+ Coordinate_Sys	string	
+ Orbit_Type	string	
+ Agency	string	
+ Satellites	structure	attribute: 'count'
++ Satellite_Descriptor	structure	attribute: 'id', repeated 'count' times
+++ Accuracy	string	
++ Base_for_Pos_or_Vel	float	
++ Base_for_Clk_or_Rate	float	
+ Comments	string	list_lv1.dat
SST_PRM_2	structure	sub-product
+ Original_Source	structure	
++ System	string	
++ Creator	string	
++ Creator_Version	string	
++ Creation_Date	string	yyyy-mm-dd hh:mm:ss
++ Format	structure	
+++ Name	string	'Rotation'
+++ Version	string	
+ Transformation	structure	
++ File_Name	string	
+ Time_Information	structure	
++ System	string	
++ GPS_Time	structure	
+++ Start	structure	
+++++ Gregorian	structure	Gregorian representation (see footnote 1)
+++++ Year	integer	



+++++ Month	integer	
+++++ Day_of_Month	integer	
+++++ Hour	integer	
+++++ Minute	integer	
+++++ Second	float	
+++ Stop	structure	
+ Epoch_Information	structure	
++ Reference	string	
+ Transformation	structure	
++ Direction	string	
+ Pole_File	string	
+ Nutation	structure	
++ Model	string	
++ Offset	string	
+ Subdaily_Model	string	

5.3.2.4 SPH product specific tags: EGM_GOC_2

Tag Name	Type	Comment
EGM_GAN_2	structure	<i>sub-product</i>
+ Original_Source	structure	
++ Format	structure	
+++ Name	string	'Grid'
+++ Version	string	
+++ Fortran_Notation	string	
+ Data_Information	structure	
++ Dataset_Name	string	
++ Description	string	
++ Unit	string	
+ Coordinate_Information	structure	attribute: 'count'
++ Latitude	structure	repeated 'count' times
+++ Northern_Border	float	attribute: 'unit'
+++ Southern_Border	float	attribute: 'unit'
+++ Cell_Information	structure	
++++ Number_of_Cells	integer	
++++ Size	float	
++ Longitude	structure	repeated 'count' times
+++ Western_Border	float	attribute: 'unit'
+++ Eastern_Border	float	attribute: 'unit'
+++ Cell_Information	structure	
++++ Number_of_Cells	integer	
++++ Size	float	
+ Flags	structure	
++ Mean_or_Point_Values	string	"mean" or "point"
++ Geocentric_or_Geodetic_Latitudes	string	"geocentric" or "geodetic"
+ Reference_Ellipsoid	string	
+ Gap_Value	float	
EGM_GRP_2	structure	<i>sub-product</i>
+ Original_Source	structure	
++ Format	structure	
+++ Name	string	'PDF'
+++ Version	string	



EGM_GEO_2	structure	<i>sub-product</i>
+ Original_Source	structure	
++ Format	structure	
+++ Name	string	'Grid'
+++ Version	string	
+++ Fortran_Notation	string	
+ Data_Information	structure	
++ Dataset_Name	string	
++ Description	string	
++ Unit	string	
+ Coordinate_Information	structure	attribute: count'
++ Latitude	structure	repeated 'count' times
+++ Northern_Border	float	attribute: 'unit'
+++ Southern_Border	float	attribute: 'unit'
+++ Cell_Information	structure	
++++ Number_of_Cells	integer	
++++ Size	float	
++ Longitude	structure	repeated 'count' times
+++ Western_Border	float	attribute: 'unit'
+++ Eastern_Border	float	attribute: 'unit'
+++ Cell_Information	structure	
++++ Number_of_Cells	integer	
++++ Size	float	
+ Flags	structure	
++ Mean_or_Point_Values	string	"mean" or "point"
++ Geocentric_or_Geodetic_Latitudes	string	"geocentric" or "geodetic"
+ Reference_Ellipsoid	string	
+ Gap_Value	float	
EGM_GVN_2	structure	<i>sub-product</i>
+ Original_Source	structure	
++ Format	structure	
+++ Name	string	'Grid'
+++ Version	string	
+++ Fortran_Notation	string	
+ Data_Information	structure	
++ Dataset_Name	string	
++ Description	string	
++ Unit	string	
+ Coordinate_Information	structure	attribute: count'
++ Latitude	structure	repeated 'count' times
+++ Northern_Border	float	attribute: 'unit'
+++ Southern_Border	float	attribute: 'unit'
+++ Cell_information	structure	
++++ Number_of_Cells	integer	
++++ Size	float	
++ Longitude	structure	repeated 'count' times
+++ Western_Border	float	attribute: 'unit'
+++ Eastern_Border	float	attribute: 'unit'
+++ Cell_Information	structure	
++++ Number_of_Cells	integer	
++++ Size	float	
+ Flags	structure	
++ Mean_or_Point_Values	string	"mean" or "point"
++ Geocentric_or_Geodetic_Latitudes	string	"geocentric" or "geodetic"



+ Reference_Ellipsoid	string	
+ Gap_Value	float	
EGM_GVE_2	structure	<i>sub-product</i>
+ Original_Source	structure	
++ Format	structure	
+++ Name	string	'Grid'
+++ Version	string	
+++ Fortran_Notation	string	
+ Data_Information	structure	
++ Dataset_Name	string	
++ Description	string	
++ Unit	string	
+ Coordinate_Information	structure	attribute: 'count'
++ Latitude	structure	repeated 'count' times
+++ Northern_Border	float	attribute: 'unit'
+++ Southern_Border	float	attribute: 'unit'
+++ Cell_Information	structure	
++++ Number_of_Cells	integer	
++++ Size	float	
++ Longitude	structure	repeated 'count' times
+++ Western_Border	float	attribute: 'unit'
+++ Eastern_Border	float	attribute: 'unit'
+++ Cell_Information	structure	
++++ Number_of_Cells	integer	
++++ Size	float	
+ Flags	structure	
++ Mean_or_Point_Values	string	"mean" or "point"
++ Geocentric_or_Geodetic_Latitudes	string	"geocentric" or "geodetic"
+ Reference_Ellipsoid	string	
+ Gap_Value	float	
EGM_GCF_2	structure	<i>sub-product</i>
+ Original_Source	structure	
++ Format	structure	
+++ Name	string	'ICGEM'
+++ Version	string	
+ Product_Type	string	
+ Model_Name	string	
+ Earth_Gravity_Constant	float	
+ Spherical_Harmonic_Development	structure	
++ Radius	float	
++ Max_Degree	integer	
+ Errors	string	
+ Normalization	string	
+ Tide_System	string	
+ Comments	string	
EGM_GER_2	structure	<i>sub-product</i>
+ Original_Source	structure	
++ Format	structure	
+++ Name	string	'Grid'
+++ Version	string	
+++ Fortran_Notation	string	
+ Data_Information	structure	
++ Dataset_Name	string	
++ Description	string	



++ Unit	string	
+ Coordinate_Information	structure	attribute: 'count'
++ Latitude	structure	repeated 'count' times
+++ Northern_Border	float	attribute: 'unit'
+++ Southern_Border	float	attribute: 'unit'
+++ Cell_Information	structure	
++++ Number_of_Cells	integer	
++++ Size	float	
++ Longitude	structure	
+++ Western_Border	float	attribute: 'unit'
+++ Eastern_Border	float	attribute: 'unit'
+++ Cell_Information	structure	
++++ Number_of_Cells	integer	
++++ Size	float	
+ Flags	structure	
++ Mean_or_Point_Values	string	"mean" or "point"
++ Geocentric_or_Geodetic_Latitudes	string	"geocentric" or "geodetic"
+ Reference_Ellipsoid	string	
+ Gap_Value	float	

5.3.2.5 SPH product specific tags: SST_AUX_2

Tag Name	Type	Comment
Original_Source	structure	
+ Format	structure	
++ Name	string	'ICGEM'
++ Version	string	
Product_Type	string	
Model_Name	string	
Earth_Gravity_Constant	string	
Spherical_Harmonic_Development	structure	
+ Radius	float	
+ Max_Degree	integer	
Errors	string	
Normalization	string	
Tide_System	string	

5.3.3 XML Data Block File

This section contains the XML ASCII file syntax definition of the Data Block files of the L2 products send to the PDS/LTA by the HPF.

5.3.3.1 EGG_NOM_2_

Tag Name	Type	Comment
List_of_GG_time_Records	structure	attribute: 'count'
+ GG_time_Record	structure	repeated 'count' times
++ Time_Information	structure	
+++ GPS_Time	string	attribute: 'unit'
++ Gravity_Gradients	structure	attribute: 'unit'



+++ XX	string	
+++ YY	string	
+++ ZZ	string	
+++ XY	string	
+++ XZ	string	
+++ YZ	string	
++ Sigmas	structure	attribute: 'unit'
+++ XX	string	
+++ YY	string	
+++ ZZ	string	
+++ XY	string	
+++ XZ	string	
+++ YZ	string	
++ Flags	structure	
+++ XX	string	
+++ YY	string	
+++ ZZ	string	
+++ XY	string	
+++ XZ	string	
+++ YZ	string	
++ Corrections	structure	attribute: 'unit'
+++ Temporal	structure	
++++ Tidal	structure	
+++++ Direct_Tides	structure	
+++++ XX	string	
+++++ YY	string	
+++++ ZZ	string	
+++++ XY	string	
+++++ XZ	string	
+++++ YZ	string	
+++++ Solid_Earth	structure	
+++++ XX	string	
+++++ YY	string	
+++++ ZZ	string	
+++++ XY	string	
+++++ XZ	string	
+++++ YZ	string	
+++++ Ocean_Tides	structure	
+++++ XX	string	
+++++ YY	string	
+++++ ZZ	string	
+++++ XY	string	
+++++ XZ	string	
+++++ YZ	string	
+++++ Pole_Tides	structure	
+++++ XX	string	
+++++ YY	string	
+++++ ZZ	string	
+++++ XY	string	
+++++ XZ	string	
+++++ YZ	string	
++++ Non-Tidal	structure	
+++++ XX	string	
+++++ YY	string	



++++++ ZZ	string	
++++++ XY	string	
++++++ XZ	string	
++++++ YZ	string	
+++ Calibration	structure	
++++ XX	string	
++++ YY	string	
++++ ZZ	string	
++++ XY	string	
++++ XZ	string	
++++ YZ	string	
++ Quaternions	structure	
+++ Q1	string	
+++ Q2	string	
+++ Q3	string	
+++ Q4	string	

5.3.3.2 EGG_TRF_2_

Tag Name	Type	Comment
List_of_GG_spatial_Records	structure	attribute: 'count'
+ GG_spatial_Record	structure	repeated 'count' times
++ Time_Information	structure	
+++ GPS_Time	string	attribute: 'unit'
++ Position	structure	
+++ Radius_from_Geocenter	float	attribute: 'unit'
+++ Phi	float	attribute: 'unit'
+++ Lambda	float	attribute: 'unit'
++ Gravity_Gradients	structure	attribute: 'unit'
+++ XX	string	
+++ YY	string	
+++ ZZ	string	
+++ XY	string	
+++ XZ	string	
+++ YZ	string	
++ Sigmas	structure	attribute: 'unit'
+++ XX	string	
+++ YY	string	
+++ ZZ	string	
+++ XY	string	
+++ XZ	string	
+++ YZ	string	
++ Flags	structure	
+++ XX	string	
+++ YY	string	
+++ ZZ	string	
+++ XY	string	
+++ XZ	string	
+++ YZ	string	



5.3.3.3 SST_PSO_2

Tag Name	Type	Comment
SST_PCV_2	structure	<i>sub-product</i>
+ List_of_Covariance_Records	structure	attribute: 'count'
++ Covariance_Record	float	attribute: 'row' and 'column'
SST_PKI_2	structure	<i>sub-product</i>
+ List_of_SP3c_Records	structure	attribute: 'count'
++ SP3c_Record	structure	repeated 'count' times
+++ Time_Information	structure	
++++ GPS_Time	structure	
+++++ Start	structure	
+++++ Gregorian	structure	Gregorian representation ²
+++++ Year	integer	
+++++ Month	integer	
+++++ Day_of_Month	integer	
+++++ Hour	integer	
+++++ Minute	integer	
+++++ Second	float	
+++ List_of_Satellite_IDs	structure	
++++ <satID>	structure	ID of Satellite (see header)
++++ Position	structure	attribute: 'unit'
+++++ X	float	
+++++ Y	float	
+++++ Z	float	
++++ Clock	float	attribute: 'unit'
++++ Standard_Deviations	structure	
++++ Position	float	attribute: 'unit'
+++++ X	float	
+++++ Y	float	
+++++ Z	float	
++++ Clock	float	attribute: 'unit'
++++ Clock	float	attribute: 'unit'
++++ Velocity	structure	attribute: 'unit', <i>optional</i>
+++++ X	float	
+++++ Y	float	
+++++ Z	float	
++++ Clock_Change_Rate	float	attribute: 'unit'
++++ Standard_Deviations	structure	
++++ Velocity	float	attribute: 'unit'
+++++ X	float	
+++++ Y	float	
+++++ Z	float	
++++ Clock_Change_Rate	float	attribute: 'unit'
SST_PRD_2	structure	<i>sub-product</i>
+ List_of_SP3c_Records	structure	attribute: 'count'
++ SP3c_Record	structure	repeated 'count' times
+++ Time_Information	structure	
++++ GPS_Time	structure	
+++++ Start	structure	
+++++ Gregorian	structure	Gregorian representation (see footnote 2)

² The tag <Gregorian> under a <GPS_Time> tag means GPS time expressed in year, month, day, hours, minutes and seconds



+++++++ Year	integer	
+++++++ Month	integer	
+++++++ Day_of_Month	integer	
+++++++ Hour	integer	
+++++++ Minute	integer	
+++++++ Second	float	
+++ List_of_Satellite_IDs	structure	
++++ <satID>	structure	ID of Satellite (see header)
+++++ Position	structure	attribute: 'unit'
+++++++ X	float	
+++++++ Y	float	
+++++++ Z	float	
+++++ Clock	float	attribute: 'unit'
+++++ Standard_Deviations	structure	
+++++ Position	float	attribute: 'unit'
+++++++ X	float	
+++++++ Y	float	
+++++++ Z	float	
+++++ Clock	float	attribute: 'unit'
+++++ Velocity	structure	attribute: 'unit', <i>optional</i>
+++++++ X	float	
+++++++ Y	float	
+++++++ Z	float	
+++++ Clock_Change_Rate	float	attribute: 'unit'
+++++ Standard_Deviations	structure	
+++++ Velocity	float	attribute: 'unit'
+++++++ X	float	
+++++++ Y	float	
+++++++ Z	float	
+++++ Clock_Change_Rate	float	attribute: 'unit'
SST_PRM_2	structure	<i>sub-product</i>
+ List_of_Rotation_Records	structure	attribute: 'count'
++ Rotation_Record	structure	repeated 'count' times
+++ Time_Information	structure	
++++ Time_Since_Reference_Epoch	float	attribute: 'unit'
+++ Quaternions	structure	
++++ Q1	float	
++++ Q2	float	
++++ Q3	float	
++++ Q4	float	
SST_PRP_2	structure	<i>sub-product</i>
+ List_of_PDF_Files	structure	attribute: 'count'
++ PDF_File	string	attribute: 'encoding', encoded PDF file

5.3.3.4 EGM_GOC_2_

Tag Name	Type	Comment
EGM_GAN_2	structure	<i>sub-product</i>
+ List_of_Latitudes	structure	attribute: 'count'
++ Latitude	structure	attribute: 'degree', repeated 'count' times
+++ List_of_Longitudes	structure	attribute: 'count'
++++ Longitude	structure	repeated 'count' times



++++ Value	float	attribute: 'unit'
EGM_GCF_2	structure	sub-product
+ List_of_ICGEM_Records	structure	attribute: 'count'
<i>For a detailed description of an ICGEM record see SST_AUX_2 in paragraph 5.3.3.5</i>		
EGM_GEO_2	structure	sub-product
+ List_of_Latitudes	structure	attribute: 'count'
++ Latitude	structure	attribute: 'degree', repeated 'count' times
+++ List_of_Longitudes	structure	attribute: 'count'
++++ Longitude	structure	repeated 'count' times
++++ Value	float	attribute: 'unit'
EGM_GER_2	structure	sub-product
+ List_of_Latitudes	structure	attribute: 'count'
++ Latitude	structure	attribute: 'degree', repeated 'count' times
+++ List_of_Longitudes	structure	attribute: 'count'
++++ Longitude	structure	repeated 'count' times
++++ Value	float	attribute: 'unit'
EGM_GRP_2	structure	sub-product
+ List_of_PDF_Files	structure	attribute: 'count'
++ PDF_File	string	attribute: 'encoding', encoded PDF file
EGM_GVE_2	structure	sub-product
+ List_of_Latitudes	structure	attribute: 'count'
++ Latitude	structure	attribute: 'degree', repeated 'count' times
+++ List_of_Longitudes	structure	attribute: 'count'
++++ Longitude	structure	repeated 'count' times
++++ Value	float	attribute: 'unit'
EGM_GVN_2	structure	sub-product
+ List_of_Latitudes	structure	attribute: 'count'
++ Latitude	structure	attribute: 'degree', repeated 'count' times
+++ List_of_Longitudes	structure	attribute: 'count'
++++ Longitude	structure	repeated 'count' times
++++ Value	float	attribute: 'unit'

5.3.3.5 SST_AUX_2

Tag Name	Type	Comment
List_of_ICGEM_Records	structure	attribute: 'count'
+ ICGEM_Record	structure	attribute: 'type', repeated 'count' times For Earth gravity field models, type can be: 'GFC', 'GFCT' or 'DOT', For Ocean and Atmosphere tides, type can be: 'LOVNR', 'OCS', 'ACS', 'CCS', 'OAP', 'AAP' or 'CAP'
++ Degree	integer	for all record types
++ Order	integer	for all record types, except 'LOVNR'
++ Load_Love_Number	integer	only for record type 'LOVNR'
++ Pro_or_Retro	string	for all ocean and atmosphere tides record types, except 'LOVNR'
++ Doodson_Number	integer	for all ocean and atmosphere tides record types, except 'LOVNR'
++ Clm	float	for all record types, except 'LOVNR', 'OAP', 'AAP' and 'CAP'
++ Slm	float	for all record types, except 'LOVNR', 'OAP', 'AAP' and 'CAP'



++ Alm	float	only for record types 'OAP', 'AAP' and 'CAP'
++ Plm	float	only for record types 'OAP', 'AAP' and 'CAP'
++ Sigmas	structure	when errors != "no", for all record types, except 'LOVNR'
+++ C	float or structure	float when errors = "calibrated" or "formal", structure when errors = "calibrated_and_formal", for all record types, except 'LOVNR', 'OAP', 'AAP' and 'CAP'
+++ A	float or structure	float when errors = "calibrated" or "formal", structure when errors = "calibrated_and_formal", only for record types 'OAP', 'AAP' and 'CAP'
++++ Calibrated	float	only when errors = "calibrated_and_formal"
++++ Formal	float	only when errors = "calibrated_and_formal"
+++ S	float or structure	float when errors = "calibrated" or "formal", structure when errors = "calibrated_and_formal"
+++ P	float or structure	float when errors = "calibrated" or "formal", structure when errors = "calibrated_and_formal", only for record types 'OAP', 'AAP' and 'CAP'
++++ Calibrated	float	only when errors = "calibrated_and_formal"
++++ Formal	float	only when errors = "calibrated_and_formal"
+++ Date	integer	only for record type 'GFCT'
+++ Comment	string	<i>optional</i>
+ Comment	string	<i>optional</i>

Example:

ICGEM record used in HPF gravity field products EGM_GOC_2_ and SST_AUX_2_):

Tag Name	Type	Comment
ICGEM_Record	structure	type="GFC"
+ Degree	integer	
+ Order	integer	
+ Clm	float	
+ SIm	float	
+ Sigmas	structure	
++ C	float	
++ S	float	

5.4 EGM_GVC_2_ FORMAT

General Product Layout

Due to the size of the variance-covariance product it is not stored in XML format, but in a specific ASCII format specified below. A header in XML will be included. This product is not distributed by on-line access, but only via DVD copies.

Due to a maximum file size of 2 GB for some operating systems the matrix is distributed among several files. The splitting of the lower triangle shall be done row-wise (in order to facilitate the handling of block-diagonal approximations). The matrix entries of each harmonic order m is stored in a separate file. The numbering of the files is done by a consecutive numbering scheme in the file name. The following figure illustrates the file splitting for an example with maximum degree and order 4.

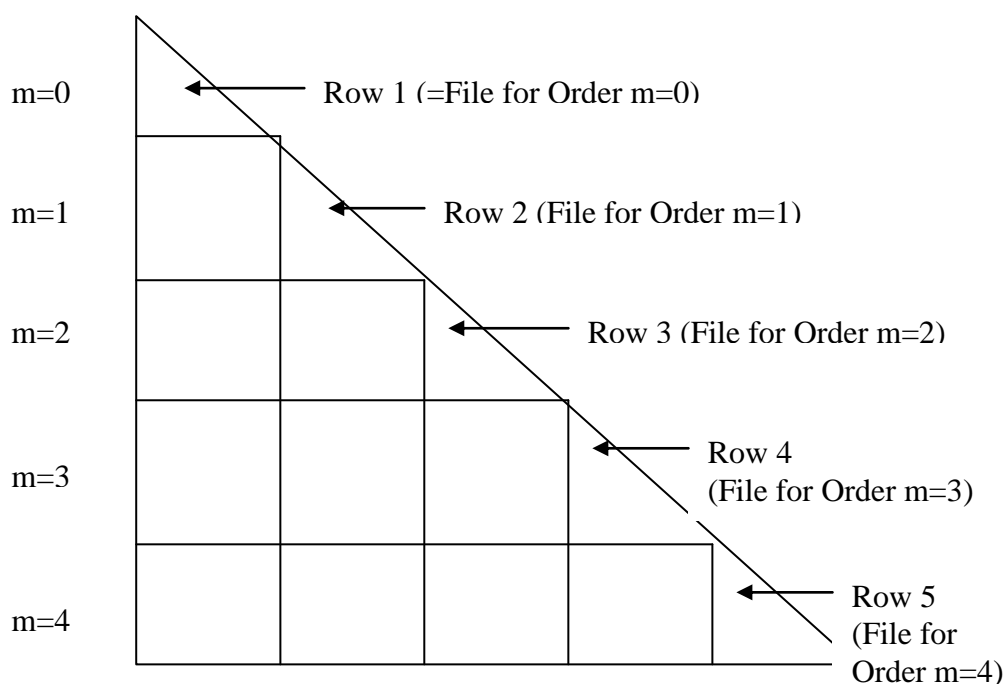

Meta Data File:

The set of files is complemented by a general-meta data ASCII file describing the whole file sequence. This general meta-data file contains all information what is required to identify and read the subsequent data files of the variance-covariance matrix. In the product this file has the extension “.IIH”. The following list shows the entries provided in the general meta-data file. Each keyword has to be read with a fixed length of 30 characters, while the maximum length for the related parameter is fixed to 70 characters.

Keyword [30 characters fixed length, filled with blanks]	Meaning of parameters [<70 characters]
product_type	Variance-covariance matrix
modelname	Name of the model
earth_gravity_constant	Earth gravity constant multiplied by mass, which has been used for the gravity field model (GM). This value might be required for error propagation.
radius	Radius of sphere which has been used for the gravity field model. This value might be required for error propagation.
max_degree	Maximum degree of the spherical harmonic series
errors	Must be set to: "formal", "calibrated" or "calibrated_and_formal" depending on the type of the errors
covariance_matrix_type	Covariance file type: "full" or "block" Full means a full system, block means a block-diagonal system.
sequence_number_entries	Number of coefficients in the matrix. After this entry the sequence of the coefficients is provided. Each coefficient is described in one line. The sequence of the coefficients must be according to the order of the spherical harmonic series (see figure above).
[C,S]_nnn_mmm	Coefficient description with degree nnn and order mmm
sequence_number_files	Number of files that belong to the variance-covariance matrix file. Each file name is then provided in a subsequent record. Files are stored per harmonic order.
	List of file names (each in a new record without keyword)

The following example shows the meta data file for the example with a maximum degree and order 4 (see previous figure) for a specific ordering scheme inside the orders. The file name of this file is chosen as "meta_data_file_1.IIH"

```

product_type          variance-covariance matrix
modelname            EXAMPLE-MODEL-1
earth_gravity_constant 0.3986004415E+15
radius               0.6378136460E+07
max_degree           4
errors               formal
covariance_matrix_type full
sequence_number_entries 25
                    C_000_000
                    C_001_000
                    C_002_000
                    C_003_000
                    C_004_000
                    C_001_001
                    C_002_001
                    C_003_001
                    C_004_001
                    S_001_001
                    S_002_001
                    S_003_001
                    S_004_001
                    C_002_002
                    C_003_002
                    C_004_002
                    S_002_002
                    S_003_002
                    S_004_002

```

```

C_003_003
C_004_003
S_003_003
S_004_003
C_004_004
S_004_004
sequence_number_files      5
data_file_1_000
data_file_1_001
data_file_1_002
data_file_1_003
data_file_1_004

```

Data File:

The data files themselves are stored in ASCII and include in the first lines the following meta data. Each keyword has to be written with a fixed length of 30 characters, while the maximum length for the related parameter is fixed to 70 characters.

Keyword [30 characters fixed length, filled with blanks]	Meaning of parameters [<70 characters]
meta_data_file_name	Name of the meta data file
order	Harmonic order of the file
number_entries	Total number of data values in the file (for control information)
begin_data	Keyword indicating where the data section starts
end_data	Keyword indicating where the data section ends.

The data files are stored in row-wise order (one entry per line free ASCII formatted in order to avoid problems with the record length). The sequence for order 1 of the previous example with a maximum order of 4 is shown in the following figure. The numbers in the drawing indicate the sequence how the elements are stored in the file.

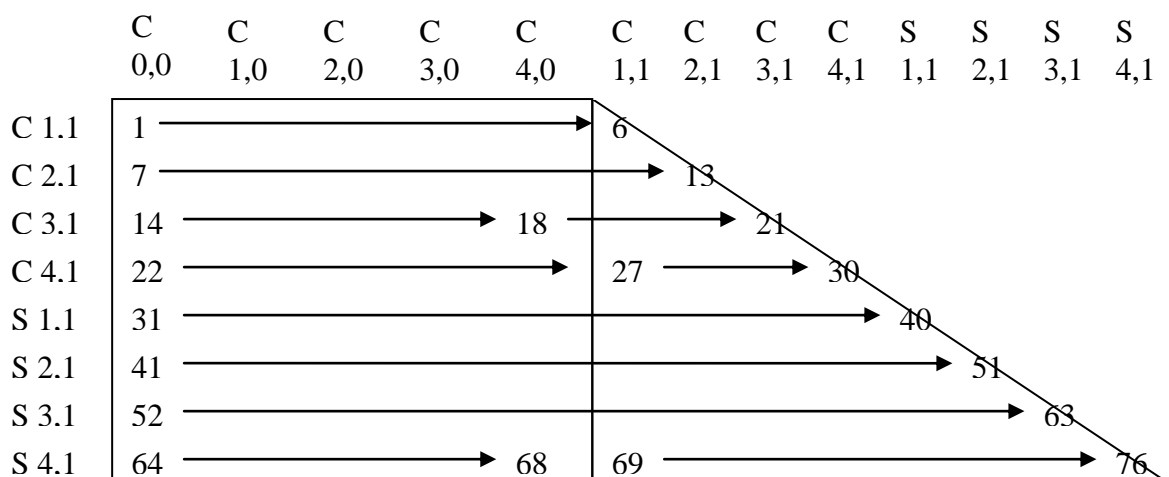

Below the example file for a subsequent data file is provided (the sample file is related to the figure above):

```

meta_data_file_name      meta_data_file_1.IIH

```

```

order                               1
number_entries                       76
begin_data
-0.7657887654320E-09
...
...
...
...           (all together 76 numbers in ASCII format)
...
...
+1.0567758766890E-14
end_data

```

Example for Different Ordering:

It shall be noted that the sequence inside the orders is flexible and can be different from the example as shown above. For a different sequence of coefficients inside the orders the meta data file has to describe the correct sequence of the data as they are provided in the data file. Below an alternative example for a variance-covariance matrix with maximum degree of 4 and a different ordering is shown. Now the file name of this meta-data file is chosen as “*meta_data_file_2.IIH*”

```

product_type           variance-covariance matrix
modelname              EXAMPLE-MODEL-2
earth_gravity_constant 0.3986004415E+15
radius                0.6378136460E+07
max_degree            4
errors                formal
covariance_matrix_type full
sequence_number_entries 25
    C_000_000
    C_002_000
    C_004_000
    C_001_000
    C_003_000
    C_001_001
    C_003_001
    C_002_001
    C_004_001
    S_001_001
    S_003_001
    S_002_001
    S_004_001
    C_002_002
    C_004_002
    C_003_002
    S_002_002
    S_004_002
    S_003_002
    C_003_003
    C_004_003
    S_003_003
    S_004_003
    C_004_004
    S_004_004

```

```
sequence_number_files      5
    data_file_2_000
    data_file_2_001
    data_file_2_002
    data_file_2_003
    data_file_2_004
```

The data file for this example then has the following sequence:

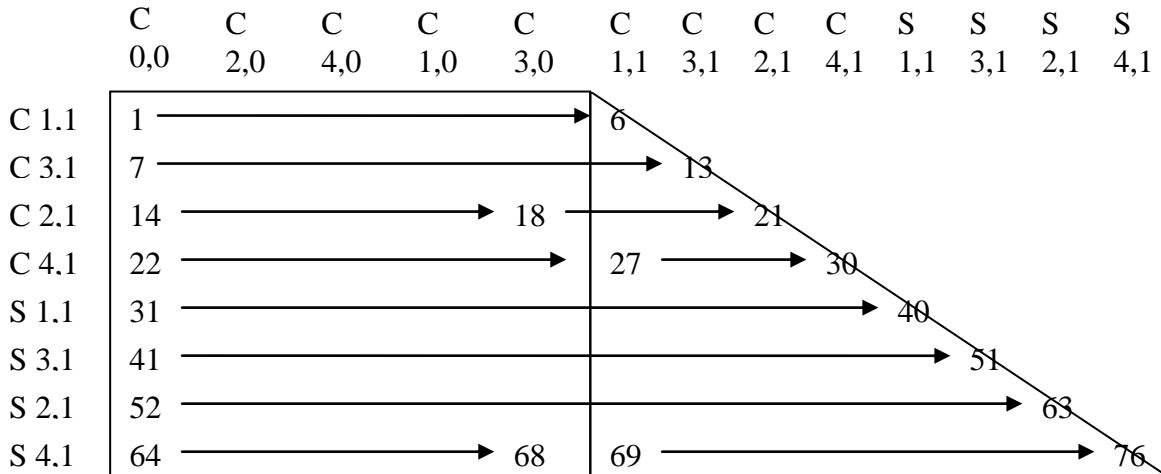

```
meta_data_file_name      meta_data_file_2.IIH
order                    1
number_entries           76
begin_data
-0.7657887654320E-09
...
...
...
...          (all together 76 numbers in ASCII format)
...
...
+1.0567758766890E-14
end_data
```

Estimation of File Sizes:

The maximum number of elements in a file for a maximum degree of 250 is 12173185 (at order 106) and 20993274 for maximum degree of 300 (at order 127). Under the assumption that we need not more than 20 bytes for 1 elements this sums up to a maximum file size of about 250 MB (for a maximum degree 250) and to 420 MB (for a maximum degree 300). These files can be easily handled by all computer systems.

5.5 GRD/GRC_SPW_2_ FORMAT

General Product Layout

The gravity gradient grid products are not stored in XML format, but in a specific ASCII format specified below.

The file consists of:

- an internal header
- 6 (or less) columns with grid gravity gradients, sorted by latitude (Vee, Vnn, Vrr, Ven, Ver, Vnr, or Tzz)
- 6 (or less) columns with error estimates, sorted by latitude (σ Vee, σ Vnn, σ Vrr, σ Ven, σ Ver, σ Vnr, or stdTzz)
- 2 (or less) columns with gravity anomalies and estimated errors (only for GRC product) (Dg, std Dg)

Where:

- Vee: East gravity gradient of gravity potential V
- Ven: mixed East-North gravity gradient of gravity potential V
- Ver: mixed East-Radial gravity gradient of gravity potential V
- Vnn: North gravity gradient of gravity potential V
- Vnr: mixed North-Radial gravity gradient of gravity potential V
- Vrr: radial gravity gradient of gravity potential V
- σ Vxy: error estimates for the gravity gradient xy
- Tzz: radial gravity gradient of disturbing potential
- stdTzz: estimated error of radial gravity gradient Tzz
- Dg: gravity anomaly
- StdDg: estimated error of gravity anomaly

The main differences between GRD and GRC products are the grid resolution / altitude and the estimated functionals (gravity gradients for GRD and e.g. gravity anomalies and second radial derivatives for GRC).

The grid data points are sorted by columns, this means data for column 1 are followed by data by column 2 and so forth (see illustration and example below):

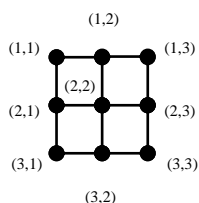

→ (1,1); (2,1); (3,1); (1,2); (2,2); (3,2); (1,3); (2,3); (3,3)

Vee11	Vnn11	...	σ Vee11	σ Vnn11	...
Vee21	Vnn21	...	σ Vee21	σ Vnn21	...
Vee31	Vnn31	...	σ Vee31	σ Vnn31	...
...
VeeN1	VnnN1	...	σ VeeN1	σ VnnN1	...
Vee12	Vnn12	...	σ Vee12	σ Vnn12	...
Vee22	Vnn22	...	σ Vee22	σ Vnn22	...
Vee32	Vnn32	...	σ Vee32	σ Vnn32	...
...
VeeN2	VnnN2	...	σ VeeN2	σ VnnN2	...
...
VeeNN	VnnNN	...	σ VeeNN	σ VnnNN	...

The product file is complemented by an internal header which is described below.

Keyword [30 characters fixed length, filled with blanks]	Meaning of parameters [<70 characters]
product_type	Description of product
modelname	Name of the model
reference ellipsoid	Ellipsoid of reference potential (required only for disturbing potential and gravity anomalies)
min latitude	Minimum latitude (bottom row of grid) (in degree)
max latitude	Maximum latitude (top row of grid) (in degree)
min longitude	Minimum longitude (left column of grid) (in degree)
max longitude	Maximum longitude (right column of grid) (in degree)
delta latitude	Distance latitude grid lines (in degree)
delta longitude	Distance longitude grid lines (in degree)
number of rows	Number of rows in grid file
number of columns	Number of columns (longitudes) in grid file
number of grids	Number of values provided for each grid point
grid altitude	Geocentric height for which the grid values are provided
functionals	Sequence of functionals provided per grid point (see descriptions above)

The following example shows the first lines of a product file:

```

product_type      space-wise GOCE-only data grids
modelname         GO_CONS_GRD_SPW_2_20091101T055147_20100630T180254_0001
min latitude      -89.9000000      [degree]
max latitude      +89.9000000      [degree]
min longitude     -179.9000000     [degree]
max longitude     +179.9000000     [degree]
delta latitude    0.2000000      [degree]
delta longitude   0.2000000      [degree]
number of rows    900
number of columns 1800
number of grids   4
grid altitude     6.6376552e+006 [m]
functionals       Vee[E], Ven[E], Ver[E], Vnn[E]
-1.35489507e+003 -1.76966457e-002 -2.42098801e-002 -1.35478049e+003
-1.35489102e+003 -1.57941626e-002 -3.69133297e-002 -1.35477690e+003
-1.35488794e+003 -1.19439160e-002 -4.80821309e-002 -1.35477545e+003
-1.35488584e+003 -6.88425901e-003 -5.71397738e-002 -1.35477639e+003

```

		<p><i>GOCE Level 2 Product Data Handbook</i> Doc. Nr: GO-MA-HPF-GS-0110 Issue: 5.0 Date: 04.08.2014 Page: 84 of 84</p>
---	---	--

6. REFERENCES

- Bock H., Jäggi A., Svehla D., Beutler G., Hugentobler U., Visser P. *Precise Orbit Determination for the GOCE Satellite using GPS*, J. Adv. Space Res., 39, pp. 1638-1647, doi:10.1016/j.asr.2007.02.053.
- Dach R., Hugentobler, U., Meindl, M. et al. (Eds.). *Bernese GPS Software Version 5.0*, Astronomical Institute, University of Bern, Switzerland, January 2007.
- ESA: *Reports for Mission Selection 'The Four Candidate Earth Explorer Core Missions', Gravity Field and Steady-State Ocean Circulation Mission*; ESA SP-1233(1), ESA Publication Division, 1999.
- Heiskanen W.A., Moritz H., *Physical Geodesy*, W.H. Freeman and Company, San Francisco and London, 1967
- Hofmann-Wellenhof/Moritz, *Physical Geodesy*, Springer Verlag Wien New York, 2005
- Johanessen J., Balmino G., LeProvost C., Rummel R., Sabadini R., Sünkel H., Tscherning C.C., Visser P., Woodworth P., Hughes C., LeGrand P., Sneeuw N., Perosanz F., Aguirre-Martinez M., Rebhan H., Drinkwater M.: *The European Gravity Field and steady-state Ocean Circulation Explorer satellite mission: Its impact on Geophysics*. Surveys in Geophysics, Kluwer Academic Publishers (Hrsg.), 2003
- Kautzleben H.: *Kugelfunktionen*; Geomagnetismus und Aeronomie, Band I/Ergänzungsband, Hrsg. Fanselau, Teubner Verlagsgesellschaft Leipzig, 1965.
- Moritz, H.; Geodetic Reference System 1980. Bulletin Geodesique, Vol. 54, no. 3, pp. 395-405, 1980..
- Rummel R., Balmino G., Johanessen J., Visser P., Woodworth R.: *Dedicated Gravity Field Missions. Principles and Aims*. Journal of Geodynamics, **33**, 3-20, 2002.
- Rummel R., Gruber Th., Koop R.; *High Level Processing Facility for GOCE: Products and Processing Strategy*; Proceedings of the 2nd International GOCE User Workshop, ESA-SP569, 2004.
- Thomas, M., *Ocean induced variations of Earth's rotation – Results from a simultaneous model of global circulation and tides*, Ph.D. diss., 129 pp., Univ. of Hamburg, Germany, 2002.
- Torge, W.: *Geodesy*. 3. ed., de Gruyter, Berlin, 2001.
- Visser P., van den IJssel J., van Helleputte T., Bock H., Jäggi A., Beutler G., Hugentobler U., Svehla D. *Rapid and precise orbit determination for the GOCE satellite*, Proceedings of the 3rd GOCE User Workshop, ESA ESRIN, 6-8 November 2006.

7. ACKNOWLEDGEMENT

We gratefully acknowledge the feedback we received from a number of people about the theoretical considerations and formulas presented in this document. Special thanks go to Joachim Schwabe from the Institut für Planetare Geodäsie at Technische Universität Dresden, Germany, who provided some corrections for chapter 4.4.3.2.
