

IRS-P6

DATA USER'S MANUAL



- Introduction
- System Description
- Ground Segment
- Orbit, Coverage and Referencing Scheme
- Data Products
- Services and Data Dissemination
- Applications

RESOURCESAT - 1 (IRS - P6) DATA USER'S HANDBOOK

DOCUMENT CONTROL AND DATA SHEET

1.	Report No. and date	:	IRS-P6/NRSA/NDC/HB-10/03 October 2003
2.	Title and subtitle	:	IRS-P6 Data User's Handbook
3.	Type	:	Technical, Reference
4.	No. of pages	:	
5.	Compiled and Edited by	:	
6.	Originating Unit	:	National Remote Sensing Agency (NRSA)
7.	Contributing Units	:	ISRO Satellite Centre (ISAC), Bangalore ISRO Telemetry, Tracking and Command Network (ISTRAC), Bangalore Space Applications Centre (SAC), Ahmedabad National Natural Resources Management System (NNRMS), Bangalore ISRO HQ, Bangalore National Remote Sensing Agency (NRSA), Hyderabad
8.	Abstract	:	A reference document containing information regarding IRS-P6 mission, sensors, data reception, orbit and coverage, data processing, products and services and dissemination
9.	Key words	:	IRS-P6, LISS-III, LISS-IV, AWiFS, OBSSR, Electronic switching, Mono and multi-spectral mode, Data Reception, Orbit and Coverage, Referencing Scheme, Path/Row, Steerability, Payload Programming, Data Processing, Products, Services, Digital Browse, User Order Processing System, Dissemination
10.	Security Classification	:	Unrestricted
11.	Distribution	:	Remote Sensing Data Users' Community

CONTENTS

Section	Page No.
ORGANISATION OF THE HANDBOOK	11
1. INTRODUCTION	
1.1 INDIAN SPACE PROGRAMME	12
1.1.1 Goal	12
1.1.2 Indian Remote Sensing Programme	12
1.1.2.1 Scope	12
1.1.2.2 Indian Remote Sensing Satellite Missions	12
1.1.2.3 Future IRS Satellite Missions	13
1.2 MISSION OVERVIEW	14
1.2.1 Mission Objectives	14
1.2.2 Payload overview	14
2. SYSTEM DESCRIPTION	
2.1 SYSTEM OVERVIEW	15
2.2 SPACE SEGMENT	17
2.3 PAYLOAD SYSTEM	22
2.3.1 LISS-IV Camera	22
2.3.2 LISS-III Camera	23
2.3.3 AWiFS Camera	24
2.4 PAYLOAD DATA HANDLING SYSTEM	26
2.4.1 Base band data handling system	26
2.4.1.1 BDH for LISS-III chain	26
2.4.1.2 BDH for LISS-IV chain	26
2.4.2 Solid State Recorder	27
2.4.3 Data Handling System (RF)	27
2.4.4 Satellite Positioning System (SPS)	28
3. GROUND SEGMENT	
3.1 GROUND SEGMENT OVERVIEW	29
3.2 TTC AND SPACECRAFT CONTROL CENTRE	31
3.2.1 Introduction	31
3.2.2 Spacecraft operations	31
3.2.3 TTC network	31
3.2.4 TTC Ground Station Configuration	31
3.2.5 Functional requirements of TTC network	33
3.2.5.1 Telemetry	33
3.2.5.2 Telecommand	33

Section	Page No.
3.2.5.3 Tracking	33
3.2.5.4 Data communication	33
3.2.6 Spacecraft Control Centre	34
3.2.6.1 Computer Configuration for IRS-P6	34
3.2.6.2 Flight Dynamics operations	34
3.2.6.3 Multi-Satellite Scheduling System	35
3.2.7 Payload Programming	35
3.3 DATA RECEPTION STATION	36
3.3.1 Introduction	36
3.3.2 Ground Station Configuration	36
3.3.3 Data Acquisition System	36
3.3.3.1 Antenna System	36
3.3.3.2 Tracking Pedestal	36
3.3.3.3 Servo System	38
3.3.3.4 Receiving System	39
3.3.4 Data Archival and Level-0 System	40
3.3.4.1 Data Archival System	40
3.3.4.2 DAQLB Systems	41
3.3.4.3 Network Systems	43
3.3.4.4 Level-0 Information System	44
3.3.4.5 Timing Systems	45
3.3.4.6 Datapath Controller	45
3.3.4.7 Data Simulator	46
3.3.4.8 S-band SPS Data Acquisition System	46
3.3.4.9 Back-up Management System	46
3.4 DATA PRODUCTS GENERATION FACILITY	
3.4.1 Introduction	47
3.4.2 Data Processing Systems	47
3.5 FILMING SYSTEM	
3.5.1 Introduction	50
3.5.2 LFFS	50
3.5.3 SFFS	50
3.6 PHOTO PRODUCTS GENERATION SYSTEM	52
3.7 QUALITY ASSURANCE	
3.7.1 General criteria	54
3.7.2 Photo products criteria	54
3.7.3 Digital product criteria	54
3.7.4 Value Added Products criteria	55
3.7.5 Geometric Data Quality Control (GDQC)	56
3.7.6 QC Certificate	56
3.7.7 Screening and validation of sensitive areas/ masking in LISS-IV products	56

Section	Page No.
3.8 DATA QUALITY EVALUATION	
3.8.1 DQE parameters	58
3.8.2 DQE software package	58
3.8.3 Reference Database Generation	59
3.8.4 Histogram based detector port performance analysis	59
3.8.5 Calibration and Validation activity in DQE system	61
3.9 INTEGRATED INFORMATION MANAGEMENT SYSTEM	64
4. ORBIT, COVERAGE AND REFERENCING SCHEME	
4.1 ORBIT AND COVERAGE	66
4.2 REFERENCING SCHEME	69
4.2.1 Introduction	69
4.2.1.1 New features of IRS-P6 with respect to IRS-1c, relevant for referencing scheme and data products	69
4.2.2 Path	69
4.2.3 Row	70
4.2.4 Scene definition	70
4.2.5 Use of referencing scheme	70
4.2.6 Comparison between IRS-P6 and IRS-1C referencing scheme	70
4.2.7 LISS-III referencing scheme and scene coverage	71
4.2.8 LISS-IV referencing scheme and scene coverage	71
4.2.8.1 Mono Mode	71
4.2.8.2 Multi-spectral (Mx) Mode	72
4.2.9 AWiFS referencing scheme and scene coverage	72
4.2.10 Indian and World referencing scheme maps	73
4.2.11 Determination of observation dates	74
4.2.12 Estimation of Path and Row, local clock time and other details for any point on Indian sub-continent	74
4.2.13 Framing procedure and scene centre and corner co-ordinates evaluation for the referencing scheme	76
4.2.14 Estimation of the centre and co-ordinates of LISS-III and LISS-IV scenes.	76
4.2.15 Deviations of orbit and attitude parameters and its effect on the image	79
4.2.16 Orbit determination and prediction errors	81
4.2.17 Deviation of attitude parameters	81
4.2.18 Image framing during actual operations	82
4.2.19 Impact of the deviations on overlap and side lap during operational lifetime	83
4.2.20 Accuracy of orbit and attitude parameters used for generating data products	84
4.2.21 Impact of continuous yaw steering on LISS-III, LISS-IV and AWiFS scenes.	84

Section	Page No.
5. DATA PRODUCTS	
5.1 DATA PRODUCTS	85
5.1.1 Introduction	85
5.1.2 Corrections applied to raw data	85
5.1.2.1 Radiometric corrections	85
5.1.2.2 Geometric corrections	86
5.1.3 Product types	87
5.1.4 Standard Products	87
5.1.4.1 Path/Row based products	87
5.1.4.2 Shift Along Track (SAT) products	87
5.1.4.3 Quadrant products	87
5.1.4.4 Geo-referenced products	88
5.1.4.5. Basic Stereo Products	88
5.1.5 Value Added Products	88
5.1.5.1 Precision Geocoded Products	88
5.1.5.2 Merged Products	88
5.1.5.3 Ortho Products	88
5.1.5.4 Template Registered Products	88
5.1.6 Product Options	90
5.1.7 Product Radiometric Accuracy	-
5.1.8 Location Accuracy for System Corrected Products	-
5.2 PHOTOGRAPHIC PRODUCTS	94
5.3 DIGITAL DATA FORMATS	
5.3.1 Introduction	97
5.3.2 LGSOWG format	97
5.3.3 Fast format	98
5.3.4 GeoTiFF format	98
5.3.5 HDF format	98
6. SERVICES AND DATA DISSEMINATION	
6.1 INTRODUCTION	103
6.2 USER ORDER PROCESSING SYSTEM	
6.2.1 Introduction	104
6.2.2 User order processing	104
6.2.3 Services	105
6.2.4 Order Processing and monitoring on Intranet by NDC	113
6.2.5 Off-line Order placing by NDC	113
6.2.6 Stand Alone Services	113
6.3 DIGITAL BROWSE FACILITY	
6.3.1 Introduction	114
6.3.2 Search for images based on date of pass	114

Section	Page No.
6.3.3 Search for images based on Path	115
6.3.4 Geographical area based Query	116
6.3.5 Map sheet number based Query	117
6.3.6 Point identification based Query	118
6.3.6.1 Latitude-longitude based Query	118
6.3.6.2 Location name based Query	119
6.3.7 Data ordering	119
6.4 PAYLOAD PROGRAMMING SYSTEM	
6.4.1 Introduction	120
6.4.2 Programming Requests	121
6.4.3 Programming Services	121
6.4.4 Programming Sequence and Time line	121
6.5 DATA DISSEMINATION	
6.5.1 Introduction	130
6.5.2 IRS-P6 Data Distribution	130
6.5.3 Data Down Link Access	130
6.5.4 Upgradation / Establishment of Ground Station	130
6.5.5 Data delivery	130
 7. APPLICATIONS	 133
 APPENDICES	
I ACRONYMS	140

LIST OF FIGURES

Description	Page No.	
Figure 2.1.1	Overview of IRS-P6 mission	16
Figure 2.2.1	Isometric view of IRS-P6 (stowed)	21
Figure 2.2.2	Isometric view of IRS-P6 (deployed)	21
Figure 2.3.1	LISS-IV Camera	23
Figure 2.3.2	LISS-III Camera	24
Figure 2.3.3	AWiFS-A Camera	25
Figure 2.4.1	Schematic diagram of DH (RF)	28
Figure 3.1.1	IRS-P6 Ground Segment organisation	30
Figure 3.2.1	IRSTRAC functional organisation for IRS-P6 mission support	32
Figure 3.2.2	Computer configuration for IRS-P6 mission operations support	35
Figure 3.3.1	Block Diagram of Data Acquisition System	37
Figure 3.3.2	Level-0 DAQLB Archival System	40
Figure 3.3.3	Level-0 DAQLB (Main) Archival System	41
Figure 3.3.4	Level-0 DAQLB (Backup) Archival System	42
Figure 3.3.5	Network configuration at Shadnagar Earth Station	43
Figure 3.3.6	Level-0 network connectivity	44
Figure 3.3.7	Level-0 Timing System	45
Figure 3.3.8	SPS data acquisition System	46
Figure 3.4.1	Configuration of Data Processing system	48
Figure 3.4.2	Configuration of PC- based AWiFS Data Processing system	49
Figure 3.5.1	Film gamma correction	50
Figure 3.5.2	LFFS network configuration	51
Figure 3.6.1	Photographic products generation flow	53
Figure 3.7.1	Flow chart for generation of photo products	55
Figure 3.7.2	Flow chart for generation of digital products	56
Figure 3.7.3	GDQC hardware interface layout	57
Figure 3.7.4	Format of QC certificate	57
Figure 3.8.1	Screen layout for GCP Id when reference is video chip	60
Figure 3.8.2	Screen layout for GCP Id when reference is LISS-III/PAN image with rectified corner co-ordinates	60
Figure 3.8.3	Scene histogram of all 4 bands of LISS-III sensor	61
Figure 3.8.4	North Cot Cattle farm, Chharodi as viewed by LISS-III	63
Figure 3.9.1	IIMS configuration	64
Figure 4.1.1	Ground trace pattern	67
Figure 4.1.2	Scene layout of LISS-IV and LISS-III in AWiFS main scene	67
Figure 4.1.3	Coverage due to LISS-IV off-nadir capability	68
Figure 4.2.1	LISS-III coverage pattern.	71
Figure 4.2.2	LISS-III scene layout	72
Figure 4.2.3	LISS-IV scenes (Mono) within a LISS-III scene	72
Figure 4.2.4	AWiFS scene coverage	73

Description	Page No.	
Figure 4.2.5	Sub-scenes of AWiFS within main scene	74
Figure 4.2.6	Calculations of coordinates of a point P on the earth surface.	79
Figure 4.2.7	Scale variations of image with altitude	80
Figure 4.2.8	Local time control by inclination correction	81
Figure 4.2.9	Effect of attitude errors on image	82
Figure 5.1.1	Concept of a SAT product.	88
Figure 5.1.2	LISS-III Quadrants	88
Figure 5.1.3	Concept of stereo pairs	89
Figure 5.2.1	Layout of Photographic products	95
Figure 5.2.2	Annotation details	96
Figure 5.3.1	Schematic of the required and optional components (attributes) of an SDS. The required components are shown on the left side of the figure, and the optional components are shown on the right.	99
Figure 5.3.2	HDF structure and inter- relationship	102
Figure 6.2.1	Block diagram of User Order Processing System	104
Figure 6.2.2	UOPS Home page	105
Figure 6.2.3	Page displaying the UOPS Services	106
Figure 6.2.4	Page displaying the list of scenes selected	107
Figure 6.2.5	Form for manual data entry	108
Figure 6.2.6	Product option selection form	108
Figure 6.2.7	Page displaying selected products	109
Figure 6.2.8	Form seeking shipping address details	110
Figure 6.2.9	Page displaying complete order details	111
Figure 6.2.10	Page displaying order status	112
Figure 6.2.11	Advance payment details form	112
Figure 6.2.12	Page displaying transaction details	113
Figure 6.3.1	Browse queries mainform	114
Figure 6.3.2	Date base queryform	115
Figure 6.3.3	Path based queryform	116
Figure 6.3.4	Geographical area based query form	117
Figure 6.3.5	Map sheet number based query form	118
Figure 6.3.6	Latitude-longitude based query form	119
Figure 6.4.1	Steerability of LISS-IV camera	120
Figure 6.4.2	Overall flow of the programming activities	122
Figure 6.4.3	Typical PR form	124
Figure 6.4.4	Acquisition proposal	125
Figure 6.4.5	Typical status form	126
Figure 6.4.6	IGS request form	127
Figure 6.4.7	IGS status form	128
Figure 6.4.8	Sample Programming Schedule	-
Figure 6.5.1	Flow of data transfer	131

LIST OF TABLES

Description	Page No.
Table 2.2.1 Overall specifications of IRS-P6	19
Table 2.3.1 Major specifications of LISS-IV camera	22
Table 2.3.2 Major specifications of LISS-III camera	23
Table 2.3.3 Major specifications of AWiFS camera	25
Table 3.1.1 Ground segment elements and functions	29
Table 3.2.1 Characteristics of ISTRAC network stations	33
Table 3.3.1 Specifications of Antenna and Tracking Pedestal System	38
Table 3.3.2 Specifications of Servo System	39
Table 3.3.3 Specifications of Receiving System	39
Table 3.6.1 Functions of various photographic processors	52
Table 3.7.1 Photo masters specification (Backup mode)	54
Table 3.8.1 Saturation radiance values at various Gains/Exposures	62
Table 4.1.1 IRS-P6 orbit	66
Table 4.1.2 Overlap and sidelap between the scenes	66
Table 4.2.1 Typical Orbital Calendar of IRS-P6	75
Table 4.2.2 The difference in longitude of a given row latitude and descending time	77
Table 4.2.3 Equatorial crossing longitude for paths over Indian region	78
Table 4.2.4 Equatorial crossing time (GMT) for paths over Indian region (Local time at descending node 10:30 hrs)	78
Table 5.1.1 LISS-III Products	91
Table 5.1.2 LISS-IV Products	92
Table 5.1.3 AWiFS Products	92
Table 5.1.4 Value Added Data Products	93
Table 6.4.1 Modes of OBSSR acquisition	121
Table 6.4.2 Modes of Real Time acquisition	121
Table 6.4.3 Programming sequence and timeline	122

ORGANISATION OF THE HANDBOOK

The IRS-P6 Data User's Handbook is published to provide essential information to the users about the mission - the sensors, orbit and coverage, referencing scheme, data acquisition, products, services and potential applications of the data.

Chapter 1 provides an overview of the Indian Space Programme and the resourcesat-1 mission.

Chapter 2 provides an overview of IRS-P6 space segment, data handling system and payload.

Chapter 3 covers various aspects of IRS-P6 ground segment such as mission operations and control centre; data acquisition, archival, generation and processing systems.

Chapter 4 deals with the satellite's orbit, coverage and referencing scheme.

Chapter 5 provides information on the various digital and photographic products provided by this mission.

Chapter 6 provides information on the various services provided by NDC and data dissemination schemes.

Chapter 7 contains information on the potential applications of IRS-P6 data.

1.1 INDIAN SPACE PROGRAMME

1.1.1 Goal

The goal of the Indian Space Programme is to harness space technology for applications in the areas of communications, broadcasting, meteorology, disaster warning, search and rescue operations and remote sensing. Operational systems have been realised in all the above areas during the past two decades. The remote sensing component of the programme, in particular, has successfully achieved global acceptance. Operational satellites have been indigenously built and launched, which cater to land and ocean applications.

1.1.2 Indian Remote Sensing (IRS) Programme

1.1.2.1 Scope

Remote sensing is an important part of the Indian Space Programme and the Department of Space (DOS), Government of India, is the nodal agency for the realisation of the National Natural Resources Management System (NNRMS), the National Resources Information System (NRIS) and the Integrated Mission for Sustainable Development (IMSD), besides several other national level application projects like Crop Acreage and Production Estimation (CAPE), National Drinking Water Mission and Wasteland Mapping etc., in close collaboration with the user agencies.

As a part of this programme, DOS has acquired the capability to design, develop and operate state-of-art multi-sensor satellite based systems comprising of space, ground and application segments to meet domestic and international requirements. The department also successfully operationalised the launch vehicle programme for the remote sensing satellites.

1.1.2.2 Indian Remote Sensing Satellite Missions

The following satellite missions are the important milestones, which have been crossed, in the

realisation of indigenous end-to-end remote sensing capabilities.

Bhaskara 1 and 2 : These were experimental remote sensing satellites launched in June 1979 and November 1981 respectively. Their payload consisted of TV cameras and radiometers. These satellites provided hands-on experience in achieving the goal of the Indian Space Programme.

IRS-1A and 1B : These two satellites, launched in March 1988 and August 1991 respectively, were the first generation, operational remote sensing satellites. The two identical satellites carried Linear Imaging and Self Scanning sensors (LISS-1 and LISS-II (2)) for providing data in four spectral bands with a resolution of 72.5m and 36.25m respectively with a repetivity of 22 days. These two satellites, during a period of more than a decade of operations, provided vital data for several national level projects.

IRS-P2 : This satellite was launched in October 1994 using the indigenously developed Polar Satellite Launch Vehicle (PSLV-D2). IRS-P2 carried a modified LISS camera.

IRS-1C and IRS-1D : These two satellites, launched in December 1995 and September 1997 respectively, are the second generation, operational remote sensing satellite missions with improved sensor and coverage characteristics.

The three sensors on-board the satellites are :

- * A PAN sensor with a spatial resolution of 5.8m (at nadir) in a single band in the visible region, with a swath of 70 Km (at nadir) and across track steerability of +/- 26 degrees.
- * A LISS-III multi-spectral sensor with a spatial resolution of 23.5m, operating in the visible, near infra-red bands and 70.5m resolution in the short-wave infra-red band, with a swath of 141Km.

* A Wide Field Sensor (WiFS) sensor with a spatial resolution of 188m, two spectral bands in the visible and near infra-red regions, with a swath of 810 Km.

These two satellites are providing data that can be used for resource mapping up to 1:25,000 scale. Several applications have exploited the improved capabilities of these two missions.

IRS-P3 : This satellite was launched in April 1996 by the PSLV-D3. The payload consists of two imaging sensors and one non-imaging sensor. The Wide Field Sensor (WiFS) sensor is providing data with a spatial resolution of 188m in three spectral bands, in the visible and near infra-red regions, with a swath of 810 Km. The other two sensors on-board are a Modular Opto-electronic Scanner (MOS) and an X-ray astronomy payload. WiFS and MOS data products are being disseminated to users.

OCEANSAT-1 (IRS-P4) : This satellite, the eighth one in the IRS programme, was launched in May 1999. The payload consists of an Ocean Color Monitor (OCM) operating in eight spectral in the visible and infra-red region and a Multi-frequency Scanning Microwave Radiometer (MSMR), operating in four frequencies namely 6.60, 10.61, 18 and 21 GHz. These sensors are providing data for measuring the physical and biological parameters of oceans.

1.1.2.3 Future IRS satellite Missions

Encouraged by the successful operations of the above mentioned missions, a number of missions are planned for realisation in the next few years. These missions are designed to carry suitable sensors for applications in cartography, oceanography and atmospheric studies and microwave remote sensing.

CARTOSAT-1 (IRS-P5) : This satellite will have two PAN sensors with 2.5m resolution and fore-aft stereo capability. The payload is designed to

cater to applications in cartography, terrain modeling, cadastral mapping etc.,.

OCEANSAT-2 : This satellite mission is conceived to provide continuity of services to the Oceansat-1 data users. This satellite will have enhanced capabilities. It will carry an Ocean Color Monitor (OCM) and Wind Scatterometer. Inclusion of a thermal infra-red Radiometer is also under consideration.

RISAT : This will be the first satellite to be launched by India to operate in the microwave region. The satellite will carry a multi-mode, agile Synthetic Aperture RADAR (SAR) payload operating in ScanSAR strip and Spot modes to provide images with coarse, fine and high spatial resolutions respectively. Some of the potential applications of the SAR data are Ship detection and Oil pollution monitoring, paddy crop acreage and yield estimation, flood inundation mapping, ship routing and snow mapping.

1.2 IRS-P6 MISSION OVERVIEW

1.2.1 Mission objectives

The main objectives of IRS-P6 mission are :

To provide continued remote sensing data services on an operational basis for integrated land and water resources management at micro level with enhanced multi-spectral and spatial coverage with stereo imaging capability.

To further carry out studies in advanced areas of user applications like improved crop discrimination, crop yield, crop stress, pest/disease surveillance, disaster management and urban management.

1.2.2 Payload overview

IRS-P6 (RESOURCESAT) is envisaged as a continuation of IRS-1C/1D with enhanced capabilities. The satellite is designed to provide both multi-spectral and panchromatic imagery of the Earth's surface. It has three sensors on-board : a Linear Imaging and Self Scanning sensor (LISS-III), an Advanced Wide Field Sensor (AWiFS) and a high resolution multi-spectral camera LISS-IV along with an On-Board Solid State Recorder (OBSSR). All the three cameras will be working on the 'pushbroom scanning' concept using linear arrays of Charge Coupled Devices (CCDs). In this mode of operation, each line of image is electronically scanned and contiguous lines are imaged by the forward motion of the satellite.

The LISS-IV camera is a multi-spectral high resolution camera with a spatial resolution of 5.8m at nadir. This camera can be operated in two modes : Mono and Multi-spectral. In the multispectral mode, data is collected in three spectral bands -

- 0.52 to 0.59 m (Green (band 2))
- 0.62 to 0.68 m (Red (Band 3))
- 0.76 to 0.86 m (NIR (Band 4))

In the multispectral mode, the sensor provides data corresponding to pre-selected 4096 contiguous pixels, corresponding to 23.9 Km swath. The 4K strip can be selected anywhere within the 12K pixels by commanding the start pixel number using electronic scanning scheme.

In Mono mode, the data of full 12K pixels of any one selected band, corresponding to a swath of 70 Km, can be transmitted. Nominally, Band-3 data will be transmitted in this mode.

The LISS-IV camera has the additional feature of off-nadir viewing capability by tilting the camera by +/- 26deg. This way it can provide a revisit of 5 days for any given ground area.

The LISS-III is a multi-spectral camera operating in four spectral bands, three in the visible and near infrared and one in the SWIR region, as in the case of IRS-1C/1D. The new feature in LISS-III camera is the SWIR band (1.55 to 1.7 microns), which provides data with a spatial resolution of 23.5 m unlike in IRS-1C/1D (where the spatial resolution is 70.5 m).

The AWiFS camera is realised in two electro-optic modules viz., AWiFS-A and AWiFS-B, and provides a combined swath of 740 Km. The AWiFS camera provides enhanced capabilities compared to the WiFS camera on-board IRS-1C/1D, in terms of spatial resolution (56m Vs 188m), radiometric resolution (10 bits Vs 7 bits) and Spectral bands (4 Vs 2), with the additional feature of on-board detector calibration using LEDs.

2.1 SYSTEM OVERVIEW

IRS-P6 is a three axes body stabilized spacecraft launched by PSLV-C5 into a Sun Synchronous Orbit at an altitude 817 Km. The spacecraft is designed for a nominal mission life of five years. IRS-P6 carries three optical cameras as payload.

(1) LISS-IV Camera

LISS-IV is a high resolution multi-spectral camera operating in three spectral bands (B2, B3, B4). LISS-IV provides a ground resolution of 5.8 m (at Nadir) and can be operated in either of the two modes. In the multi-spectral mode (Mx), a swath of 23 Km (selectable out of 70 Km total swath) is covered in three bands, while in mono mode (Mono), the full swath of 70 Km can be covered in any one single band, which is selectable by ground command (nominal is B3 – Red band). The LISS-IV camera can be tilted up to $\pm 26^\circ$ in the across track direction thereby providing a revisit period of 5 days.

(2) Linear Imaging Self Scanning Sensor (LISS-III)

The LISS-III camera is identical to the LISS-III flown in IRS-1C/1D spacecraft except that the spatial resolution of SWIR band (B5) is also 23.5 m (same as that of B2, B3, B4). LISS-III covers a swath of 141 Km in all the 4 bands.

(3) Advanced Wide Field Sensor (AWiFS)

AWiFS camera is an improved version compared to the WiFS camera flown in IRS-1C/1D. AWiFS operates in four spectral bands identical to LISS-III, providing a spatial resolution of 56 m and covering a swath of 740 Km. To cover this wide swath, the AWiFS camera is split into two separate electro-optic modules, AWiFS-A and AWiFS-B.

The IRS-P6 spacecraft mainframe is configured with several new features and enhanced capabilities to support the Payload operations. The payloads can be operated either in Real Time mode by direct

transmission to ground station or in Record and Playback mode using an on-board 120 GB capacity Solid State Recorder. The various modes of Payload operations can be programmed *apriori* through a Telecommand processor (TCP).

The Ground Segment consists of :

- (i) A Telemetry Tracking and Command (TTC) segment comprising of a TTC network to provide optimum satellite operations and a Mission Control Centre for mission management, spacecraft operations and scheduling.
- (ii) An Image segment comprising of data reception, data acquisition, data processing and product generation systems, along with a centralized data dissemination centre. The overview of IRS-P6 mission is shown in Figure 2.1.1.

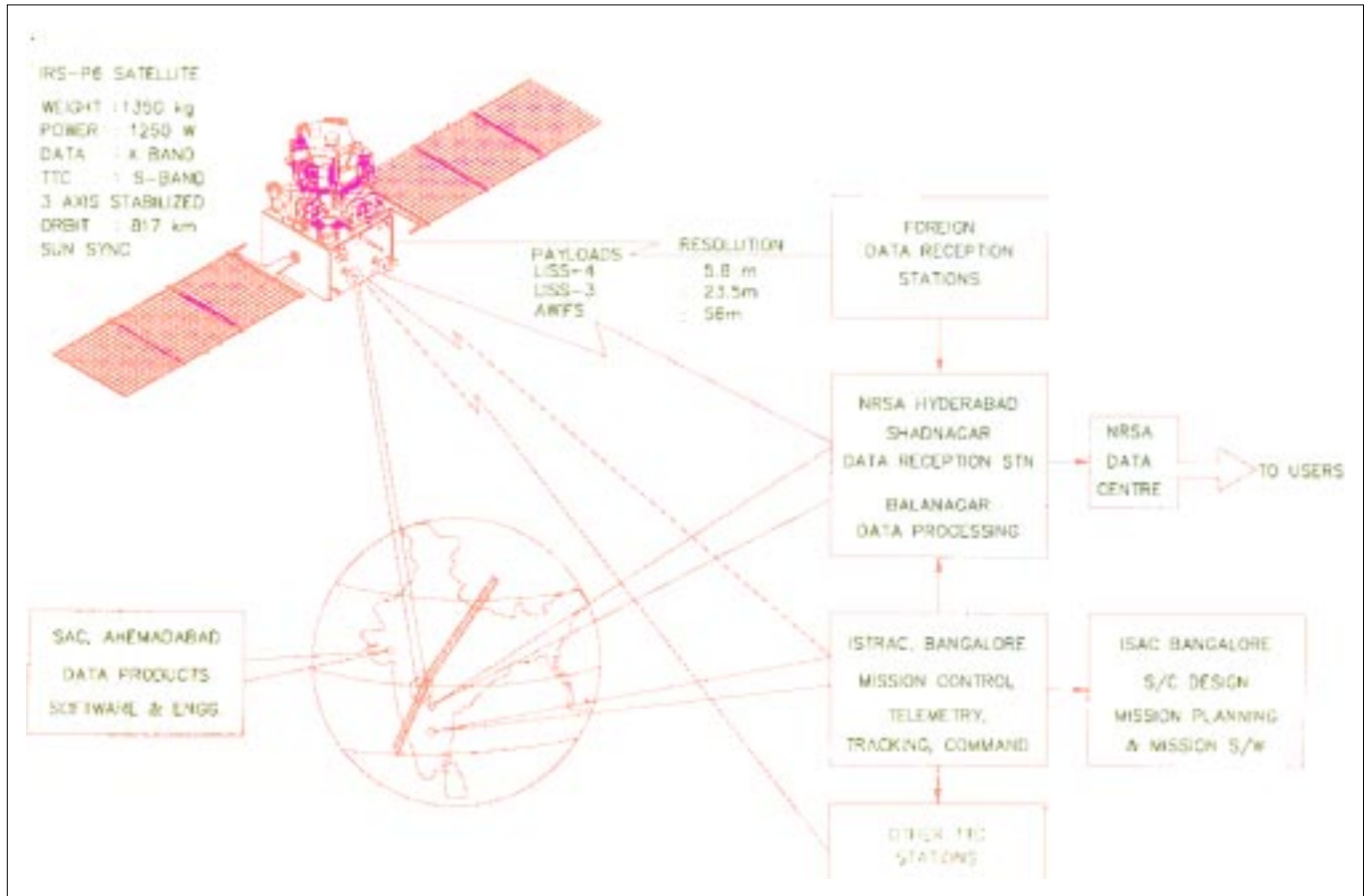

Figure 2.1.1 Overview of IRS-P6 mission

2.2 SPACE SEGMENT

The Space segment of IRS-P6 carries out the following functions :

- * Image the earth features in the required spectral band.
- * Format the payload sensor data along with auxiliary information and transmit the same to the ground station in two X-band carriers, either in RT or in Play back of on-board recorded data.
- * Provide necessary power for main frame subsystems and payload operations with a positive power margin.
- * Provide required pointing accuracy and platform stability during imaging.
- * Maintain the proper orbit by periodic correction maneuvers
- * Transmit house keeping information for various subsystems and accept telecommands to control the spacecraft.

A brief description of the spacecraft is given in the following paragraphs.

The Structure of the spacecraft consists of a Main Platform (MPL) and a Payload Platform (PPL). The main platform is built around a central load bearing cylinder of 915 mm diameter and consists of four vertical panels and two horizontal decks. The bottom of cylinder is attached to an interface ring which interfaces with the launch vehicle. The vertical panels and the horizontal decks carry various subsystem packages. Four shear panels connecting the vertical panels to the main cylinder provide structural stiffness and also support for the solar array drive motors on the Sun side and Anti-sun side. Various Attitude sensors, Satellite Positioning System (SPS) and data transmitting antennas are mounted on the outside surfaces of the equipment panels and the bottom

deck. Two Star Trackers are mounted with skewed orientation on the top deck.

The Payload Platform consists of a two-tier system – the PPL deck and the rotating deck. The PPL deck accommodates LISS-III, AWIFS-A and AWIFS-B camera modules. The LISS-IV camera is mounted on a rotating deck which is attached to a Payload Steering Motor (PSM) which can rotate by $\pm 26^\circ$. The various electronics package associated with LISS-IV are mounted on a hexagonal shaped Aluminum honeycomb cover which also serves as a thermal cover for LISS-IV. The entire rotating deck is held down during launch to take care of launch vibrations and will be released in-orbit using a steel wire rope Pyro Cutter. The entire PPL assembly is attached to a CFRP mono-coque cylinder, which in turn is attached to the main cylinder of the MPL through a strut assembly for effective load transfer.

The mono propellant Hydrazine based Reaction Control System (RCS) consists of a single propellant tank of 250 liters capacity mounted inside the MPL main cylinder. eight nos. of 1 Newton and four 11 Newton thrusters are mounted on the bottom deck. The thermal control system maintains the temperature of different subsystems within the specified limits using semi- active and active thermal control elements like paints, Multi Layer Insulation (MLI) blankets, Optical Solar Reflectors and auto-temperature Controllers. The LISS-IV CCD temperature control is implemented using a radiator plate coupled to each band CCD through heat pipes and copper braid strips. Three strip heaters mounted on the Detector Head Assembly which are in the control loop of a temperature controller maintain the CCD temperature within its operating limits of 20 ± 4 deg.C.

The power system of IRS-P6 consists of six deployable solar panels, with three panels in each wing (Sun side and Anti-sun side), each panel of size $1.4 \times 1.8 \text{ m}^2$. These solar arrays are deployed

immediately after spacecraft separation from the Launcher using deployment mechanism. Then onwards, they are continuously rotated to track the Sun using the Solar Array Drive Motor (SADM). Two solar panel Sun sensors provide the position error of each solar array with respect to the Sun vector, which is automatically corrected by SADA electronics. The rotation of solar arrays is arrested during Payload operation to minimize the disturbance on the platform. The solar arrays generate a power of 1250 W at end-of-life (EOL). Two Ni-Cd chemical batteries of 24AH capacity each, provide support during eclipse and peak loads. The power conditioning and distribution to various subsystems is achieved using core power electronics and user specific DC/DC converters. An Ampere-Hour meter is provided to monitor the Battery charge – discharge condition.

The TTC system is configured to work in S-band and comprises of three sub-systems Telemetry, Telecommand and Transponder. The Telemetry system collects the house keeping (HK) data from each subsystem, formats and modulates onto the sub-carrier. There are two formats viz., Dwell and Normal which can be simultaneously received. The telemetry data is transmitted at 1 Kbps in normal mode and 16 Kbps in play-back mode. The normal mode telemetry is modulated on 25.6 KHz sub-carrier while the play back/dwell data is modulated on 128 KHz sub-carrier for transmission. An on-board storage of 6.3 M bits capacity stores the telemetry data during non-visible period for later play back.

The Telecommand system incorporates a shortened BCH code for command reception. It provides time tag command execution as well as on-board timer (OBT) based command execution facilities. A Micro processor (80C86) based Telecommand Processor (TCP) is programmed to execute a pre-defined sequence of commands under various modes of Payload operations (real time, calibration and record/play back).

The TTC transponder transmits the telemetry data, receives the telecommand signals, demodulate the ranging tones and re-transmits them to ground with a fixed turn around ratio of 240/221 for two-way Doppler measurement.

The transponder system consists of receiving and transmitting system and can operate either in coherent mode or non-coherent mode. In coherent mode, the down link carrier is derived by PLL technique from the uplink signal. In non-coherent mode, the down link carrier is derived from an independent TCXO.

The Attitude and Orbit Control System (AOCS) supports the functions of Earth acquisition after launch, three axis body stabilization as well as orbit maintenance throughout the mission life. The AOCS is configured with a Microprocessor based control electronics with hot redundancy. The control electronics receives the attitude error measurements from sun sensors, earth sensors, star trackers, magnetometers, gyroscopes and drives the actuators – reaction wheels, magnetic torques and RCS thrusters to minimize the attitude errors. There are several special logics like auto-acquisition sequence, safe mode, auto-reconfiguration of reaction wheels in case of a single wheel failure etc.,.

The overall specifications of IRS-P6 are given in table 2.2.1. An isometric view of the spacecraft is shown in Figure 2.2.1 and 2.2.2.

Spacecraft	Three axes body stabilized spacecraft	
Orbit	Near polar, sun-synchronous, 817 Km with ECT of 10.30 a.m, descending node	
Repetevity	341 orbits / cycle (24 days)	
Revisit	5 days (LISS-IV Mono & AWIFS)	
Mainframe Systems		
Structure	Aluminium and Aluminium honeycomb with CFRP elements for MPL and PPL	
Weight	1350 Kgs	
Thermal Control		
	Passive, semi-active and active elements like OSR, MLI, Heat pipes, tape/foil heaters etc.,	
Battery	$5 \pm 5^{\circ} \text{C}$	
Payload cameras	$20 \pm 3^{\circ} \text{C}$	
Electronics	$0 - 40^{\circ} \text{C}$	
Power System		
Solar Array	6 Solar panels (1.4 x 1.8 sq.m each) generates 1250 W power at EOL	
Battery	2 x 24 Ah Ni-Cd batteries	
Power electronics	Two Raw buses 28 to 42 V Discrete and Hybrid DC-DC converters	
AOCS		
Attitude Sensors	Earth sensors, Digital Sun sensors, Star trackers, 4 Pi Sun sensors, Gyroscopes AD accuracy 0.1 deg with Earth sensors 0.006 deg. with Star trackers	
Actuators	4 nos. Reaction wheels (5 NMS); 8 nos. x 1N & 4 nos. 11N Hydrazine thrusters ; 2 nos. Magnetic torquers	
Control Electronics	Pointing accuracy	< + 0.05 deg (3 sigma)
	Drift rate	< + 5 x 10 ⁻⁵ deg/sec (3 sigma)

Table 2.2.1 Overall specifications of IRS-P6

TTC

Telemetry	Real time/Dwell	1024 Bits/sec
	Playback	16 Kbps
	Sub-carrier	25.6 KHz (RT), 128KHz (PB)
	Modulation	PCM/PSK/PM
	On-board Storage	6.3 Gbits
Telecommand	No. of ON/OFF commands	
	No. of Data commands	
	Command bit rate	100 bits/sec
	Modulation	PCM/FSK/FM/PM
	FSK sub-carrier for '1'	5.555 KHz
	FSK sub-carrier for '0'	3.125 KHz
	No.of Time-tag commands	255
	Probability of erroneous command execution	1.8×10^{-42}
	Probability of command rejection	0.98×10^{-13}
Transponder	Uplink frequency	2071.875 MHz
	Down link frequency	2250 MHz
	Turn around ratio	240/221

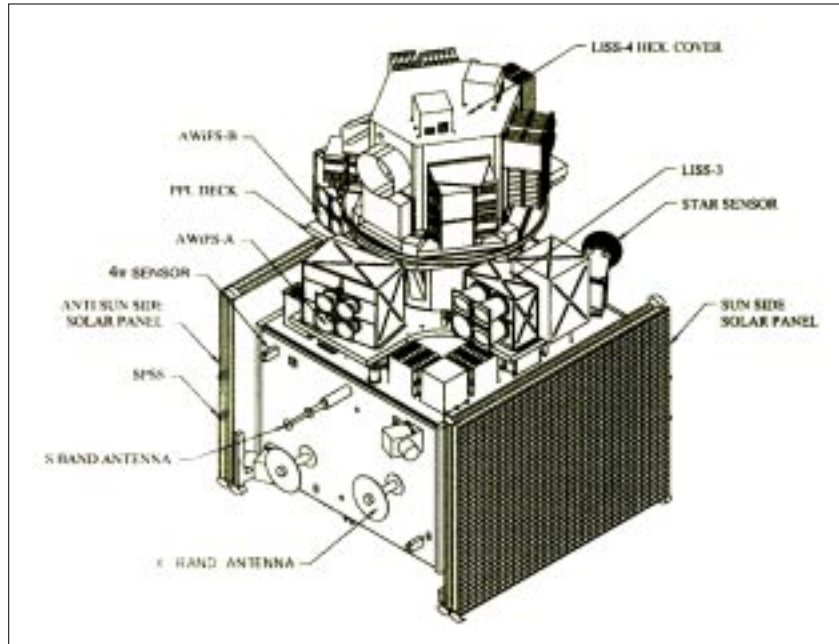

Figure 2.2.1 Isometric view of IRS-P6 (1)

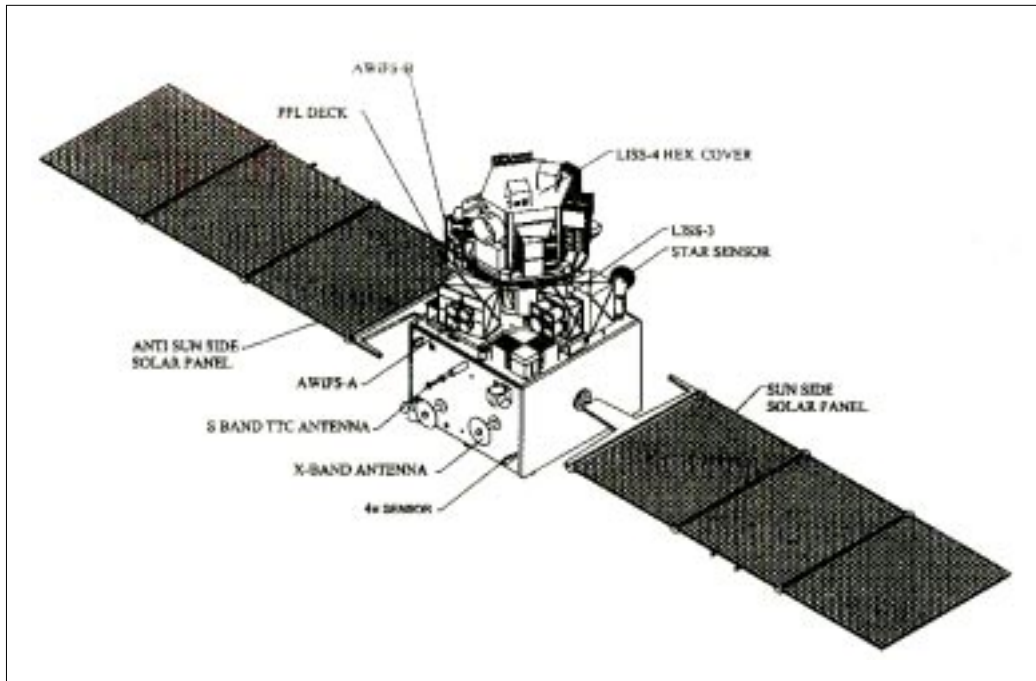

Figure 2.2.2 Isometric view of IRS-P6 (2)

2.3 PAYLOAD SYSTEMS

2.3.1 LISS-IV Camera

The LISS-IV camera is realized using the three mirror reflective telescope optics (same as that of the PAN camera of IRS-1C/1D) and 12,000 pixels linear array CCDs with each pixel of the size 7 micron x 7 micron. Three such CCDs are placed in the focal plane of the telescope along with their individual spectral band-pass filters. An optical arrangement comprising an isosceles prism is employed to split the beam into three imaging fields which are separated in the along track direction. The projection of this separation on ground translates into a distance of 14.2 Km between B2 and B4 image lines. While Band-3 is looking at nadir, Band-2 will be looking ahead and Band-4 will be looking behind in the direction of velocity vector. The CCDs employed in LISS-IV camera are of Thomson make THX31543A . Each CCD has 12K pixels, separated into 6K each of Odd and Even pixels. These odd and even pixel rows are separated by 35 microns (equal to 5 pixels). To avoid any gap in the image due to this separation coupled with the earth rotation, the spacecraft is given a rate about Yaw axis. There are 8 output ports for each CCD and each port gives output data for 1500 video pixels + 14 pre-scan pixels + 20 dummy pixels + 2 post scan pixels (total 1536 pixels per port). Each detector has eight Light Emitting Diodes (LED) for in-flight calibration. The analogue output signals from the CCDs are processed through independent port-wise electronic chains, comprising of amplifiers, DC restoration and 10 bit AD converter. The major specifications of LISS-IV camera are given in Table 2.3.1. The optical schematic is given in Figure 2.3.1.

Inflight Calibration

Pre-launch light transfer characteristics (LTC) of the overall Payload system are generated in the laboratory covering performance parameters like spectral response, dark current, dynamic range, temperature and linearity. This LTC data is used for radiometric corrections of the image data. However,

to monitor the long term performance of the detector and processing electronics, an in-flight calibration scheme is implemented using LEDs. Eight LEDs are positioned in front of the CCD (without obstructing the light path during imaging). These LEDs are driven with a constant current and the integration time is varied to get 16 exposure levels, covering the dynamic range in a sequential manner. This sequence repeats in a cyclic form.

IGFOV (across track)	5.8 m at nadir
Ground sampling distance	5.8 m at nadir
Spectral Bands (microns)	B2 0.53 - 0.59 B3 0.62 - 0.68 B4 0.77 - 0.86
Swath	23.9 Km (multispectral mode) 70 Km (MONO mode)
Saturation radiance (mw/cm ² /sr/micron)	B2 - 55 B3 - 47 B4 - 31.5
Integration time	0.877714 msec
Quantization	10 bits selected 7 bits will be transmitted by the data handling system
No. of gains	Single gain (Dynamic range obtained by sliding 7 bits out of 10 bits)

Table 2.3.1 Major specifications of LISS-IV camera



Figure 2.3.1 LISS-IV Camera

2.3.2 LISS-III Camera

The LISS-III Camera operates in four spectral bands in the VNIR and SWIR range. Each band consists of a separate lens assembly and a linear array CCD. Each lens assembly is realised with 8 refractive lens elements (a combination of convex and concave lenses), an interference filter and a neutral density filter. The VNIR bands (B2, B3, B4) use 6,000 element CCDs each with pixel size of 10 microns x 7 microns. The SWIR band (B5) uses a 6,000 element Indium Gallium Arsenide CCD with pixel size of 13 micron x 13 micron. This SWIR CCD is a new device employing CMOS readout technique for each pixel, thereby improving noise performance. The major specifications of LISS-III camera are given in Table 2.3.2.

IGFOV	23.5 m
Spectral Bands (Microns)	B2 0.52 - 0.59
	B3 0.62 - 0.68
	B4 0.77 - 0.86
	B5 1.55 - 1.70
Swath	141 Km
Saturation radiance (mw/cm ² /sr/micron)	B2 28-31
	B3 25-38
	B4 27-30
	B5 7.5
Integration time	3.32 msec
Quantization	7 bits
	SWIR band has 10 bit quantisation, selected 7 bits out of 10 bits will be transmitted by the data handling system
No. of gains	4

Table 2.3.2 Specifications of LISS-III Camera

The four band assemblies are mounted on a rigid Invar structure with their optical axis co-aligned for band to band registration. The detector electronics supplies various Clocks and bias required for the operation of the CCD and output signals from the CCDs are processed in the video processing electronics. The data from the VNIR bands are digitized to 7 bits while the data from SWIR band are digitized to 10 bit. The VNIR bands could be operated in any one of the four selectable gains by command, while the SWIR band is configured with single gain setting covering the full dynamic range.

In-flight Calibration

The In-flight calibration of the LISS-III camera is carried out using 4 LEDs per CCD in

VNIR bands and 6 LEDs for the SWIR band. These LEDs are operated in pulsed mode and the pulse duration during which these LEDs are ON is varied in specific steps. Each LED has a cylindrical lens to distribute the light intensity onto the CCD. Each calibration cycle consists of 2048 lines providing six non zero intensity levels. Each intensity level is generated sequentially by LED-1 ON, LED-2 ON and LED-1 and 2 ON .

2.3.3 AWiFS Camera

The AWiFS camera operates in four spectral bands which are identical to LISS-III . In order to cover the Wide field imaging with minimum geometric distortion, the AWiFS camera is realized

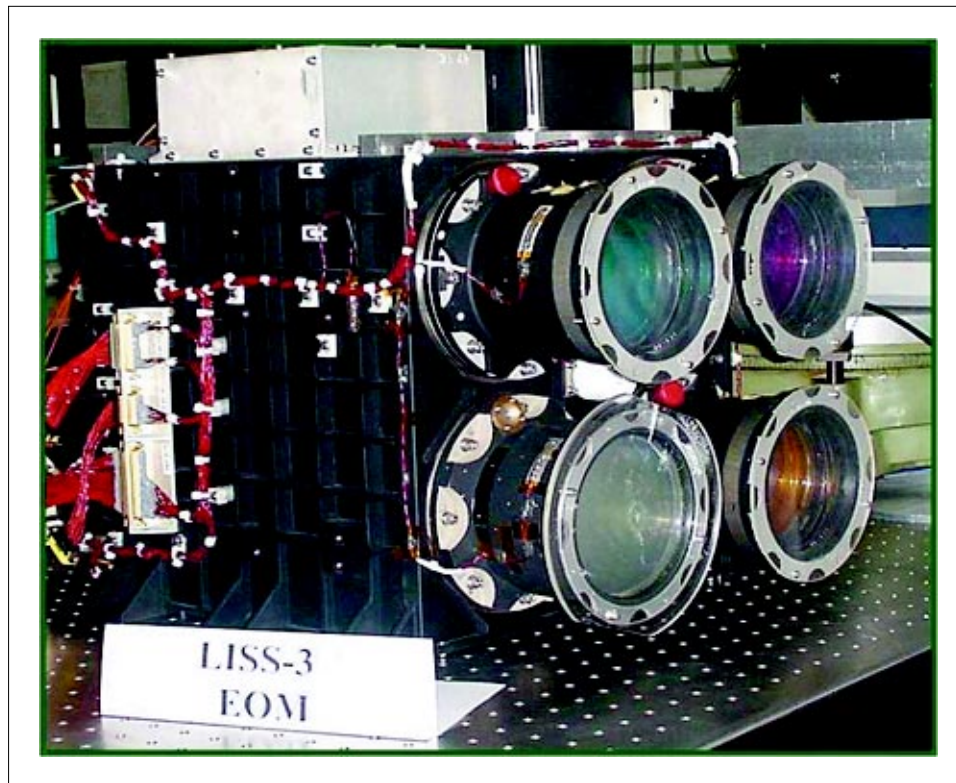

Figure 2.3.2 LISS - III Camera

using two separate electro-optic modules which are tilted by 11.94° with respect to nadir. Each module covers a swath of 370 Km providing a combined swath of 740 Km with a side lap between them. The major specifications of AWiFS camera are given in Table 2.3.3.

The electro-optic module contains refractive imaging optics alongwith band pass interference filter, a neutral density filter and a 6000 pixels linear array CCD detector for each spectral band. The CCDs used in AWiFS are identical to those of LISS-III. The output signals from each CCD are amplified and digitised into 10 bit parallel data in the video processing electronics. The in-flight calibration is implemented using 6 LEDs in front of each CCD. For the VNIR bands (B2, B3, B4), the calibration is a progressively increasing sequence of 16 intensity levels through exposure control. For the SWIR band, the calibration sequence is similar to that of LISS-III through a repetitive cycle of 2048 scan lines.

IGFOV	56 m (nadir) 70 m (at field edge)
Spectral Bands (Microns)	B2 0.52 - 0.59 B3 0.62 - 0.68 B4 0.77 - 0.86 B5 1.55 - 1.70
Swath	740 Km (combined) 370 Km each head
Saturation radiance (mw/cm ² /sr/micron)	B2 - 53 B3 - 47 B4 - 31.5 B5 - 7.5
Integration time	9.96 msec
Quantization	10 bits
No. of gains	16

Table 2.3.3 Major specifications of AWiFS camera

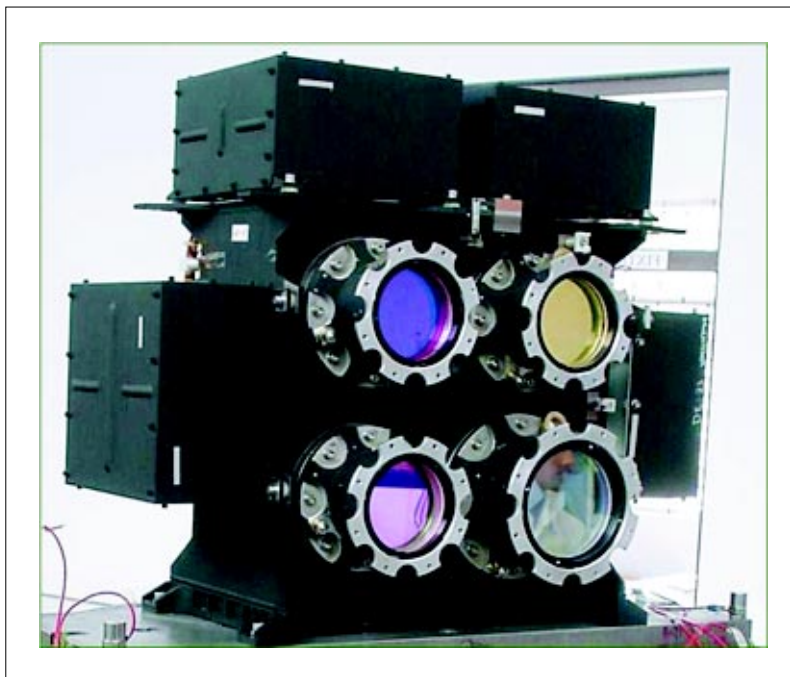

Figure 2.3.3 AWiFS - A Camera

2.4 PAYLOAD DATA HANDLING SYSTEM

The payload data handling system receives the digital data from each camera in bit parallel - byte serial mode, formats it with auxiliary data, modulates it on the RF carrier and transmits to the ground. There are two separate data handling chains, one to transmit LISS-III + AWiFS data and the second to transmit LISS-IV data, both operating at 105 Mbits/sec data rate. The DH system essentially consists of two sub-systems – Base band Data Handling (BDH) and X-band data Transmitting system. A brief description of these systems is covered in the following paragraphs.

2.4.1 Baseband data handling system

The baseband data handling system consists of two separate chains, one for LISS-III and AWiFS data and the second chain for LISS-IV data. Each chain contains two Formatter packages and a common Clock and RF Interface package with full redundancy for both the chains. In addition, there is an on-board Solid State Recorder (SSR) to record the Payload data during non-radio visible operation for later playback.

2.4.1.1 BDH for LISS-III chain

The BDH system for LISS-III chain is configured to multiplex all the four band (B2,B3, B4, B5) data of LISS-III and AWiFS cameras, formats suitably with frame sync code plus auxiliary data, differentially encode the data and transmit to the RF system for QPSK modulation. The BDH formatter gives 8 bit rate clock (BRC) and 8 wide line start pulse (WLSP) signals to the camera electronics, for both LISS-III and AWiFS with cross coupling. Similarly the video data from camera electronics is available to both main and redundant BDH systems. The parallel video data of LISS-III is shifted to the data handling system at a rate of 937 words/Sec. Similarly, for AWiFS payload, the VNIR and SWIR data is shifted at 625 Kwords/Sec and 312.5 Kwords/Sec respectively. For LISS-III, 7 bit data is transmitted in VNIR bands whereas the selected 7 consecutive bits out of

10 bits generated at payload end are transmitted in SWIR band. The selection of 7 bits for SWIR band is done by bit sliding in the BDH formatter. Subsequently, all the 4 band data are multiplexed, formatted with auxiliary data like line count, gyro fine rate, AOCE data and camera CAL status. The formatted data is serialized and sent to the QPSK modulator as a serial bit stream at 52.5 MHz.

The AWiFS data corresponding to all four bands are received as 10 bit parallel data by the BDH. This parallel data are multiplexed and formatted with the auxiliary information similar to LISS-III and transmitted to RF system for QPSK modulation as a serial bit stream at 52.5 MHz. The data handling system is configured in such a way that the full LISS-III data is transmitted in I channel while the AWiFS data is transmitted in Q Channel.

Depending on the selection by ground Command for Real-Time (RT) transmission or on-board recording in the Solid State Recorder, the formatted serial data is converted to parallel data in byte format and is given to a Selection logic for differential encoding. In the RT mode, the differentially encoded output is converted to serial stream and sent to RF for further transmission. In the recording mode, the parallel data prior to differential encoding is sent to Solid State Recorder for recording. While playing back the data from Solid State Recorder, it is differentially encoded, converted to serial stream before final transmission to RF.

2.4.1.2 BDH for LISS-IV

The BDH system of LISS-IV Camera receives the 10 bit parallel data from all 3 bands (B2, B3, B4), selects 7 consecutive bits out of the 10 bits received by bit sliding, formats the 7 bit data suitably depending on the mode of operation (Mono/ Multi-spectral), appends the data with auxiliary information and after differential encoding transmits the data to RF system for QPSK modulation.

The LISS-IV BDH gives 6 BRC and 6 WLS signals to camera electronics and receives 10 bit parallel data from the Camera electronics with cross-coupling between main and redundant systems.. This parallel data is shifted at 1.75 Mwords/sec to the data handling formatter. In the formatter, any consecutive 7 bits out of 10 bits are selected by a data command before multiplexing the data. If any one of the MSBs on the left side of selected 7 bits is "high", the selected 7 LSBs are forced to '1'. This is equivalent to digital gain selection depending on the input radiance from the scene. The LISS-IV Camera system is designed for saturation radiance corresponding to 100 % albedo in all 3 bands with 10 bit quantisation.

This slided 7 bit data is given to the multiplexing and electronic scanning logic. Here, multiplexing is done in two groups - Group-1 from pixel 1 to pixel 6000 and Group-2 from pixel 6,001 to pixel 12,000. The final multiplexed data is organized in the ascending order of the pixel numbers and written on to a memory. This is done group wise during the previous scan line integration time. This data goes simultaneously to band selector and electronic scanning. Band selector can select any single band or multi-spectral data. In the case of Mono mode, all 12K pixels are transmitted in the multi spectral mode, selected 4K consecutive pixels for each band will be transmitted. This selection of 4K pixels is carried out by electronic scanning in the BDH system. Through a ground command the start pixel can be defined from which 4K pixels are to be selected for transmission. The position of start pixel can be varied from 1 to 7936.

2.4.2 Solid State Recorder

A Solid State Recorder with 120 GB capacity is included in the Data Handling System of IRS-P6. The Solid State Recorder has got four input channels and eight output channels (4 main + 4 redundant). The LISS-III and AWiFS data is recorded as I_1 and Q_1 on two channels and the LISS-IV data is recorded

as I_2 and Q_2 in the remaining two channels. In each channel, both the recording as well as Playback is done at 52.5 MHz data rate. With the available capacity of the Solid State Recorder, the LISS-IV and LISS-III + AWiFS data can be recorded for 9 minutes each.

2.4.3 Data Handling System (RF)

The data handling system (RF) accepts the baseband data of LISS-IV and LISS-III + AWiFS at 105 Mbps from the BDH system and modulates this data on two independent X-band carriers to transmit to the ground. Each chain is configured with passive redundancy for the transmitter. The LISS-IV data are transmitted on carrier-1 at 8125 MHz and LISS-III + AWiFS data are transmitted on carrier-2 at 8300 MHz. Each transmitter has its own basic crystal oscillator (270.833 MHz for LISS-IV and 276.666 MHz for LISS-III chains). These basic frequencies are multiplied by 30 times through different stages to get the final carrier frequency. The output from TCXO is amplified to a level of + 22 dBm in two stage VHF amplifier and is fed to an L-band multiplier and a band pass filter. Here the signal is multiplied by X6 and after further amplification (to + 23 dBm), it is passed through the final multiplier where it is multiplied by X5 to get the final X-band carrier.

The TTL compatible data from base band system are modulated on the carrier through a QPSK modulator. The LISS-IV data are modulated on I_1 and Q_1 channels at 52.5 Mbps each ; the LISS-III data is modulated on I_2 channel and AWiFS data on Q_2 channel. The modulated signal is amplified through a 40 W TWTA and is fed to the shaped beam antenna for transmission. There are three TWTA's – one each for LISS-IV and LISS-III chains and the third one will serve as a redundant to either of them. A link margin of about 5 dB is available in both these chains. The schematic diagram of DH (RF) is given in Figure 2.4.1.

2.4.4 Satellite Positioning System

The Satellite Positioning System (SPS) on-board IRS-P6 is a 8-channel GPS receiver operating at 1575.42 MHz frequency. The SPS provides the position and velocity vectors of the IRS spacecraft at each instant in the orbit. There are two SPS units with full redundancy.

Each SPS consists of an 8 channel high dynamics Receiver Core Engine and a Spacecraft Interface Module. Both SPS units are mounted on the anti-Earth face of the satellite to track GPS satellites continuously. The RF front end of each SPS consists of a micro strip patch antenna to track the GPS satellite signals. The received signals are fed to a single stage Low Noise Amplifier followed by a two stage L-band amplifier.

The SPS data are transmitted in three formats - Real Time, Play Back and House Keeping through

Telemetry. The RT data consist of FSC, X, Y, Z, X-dot, Y-dot, Z-dot, GPS time, tracked GPS Ids, Pseudo ranges, delta ranges, received CNDRs (carrier to noise density ratio), indication of GPS satellites used for computation, PDOP (Position Dilution of Precision), ephemeris of the GPS satellites. These RT data are sampled at 1 sec interval. The PB data are sampled at 1 sample/10 seconds and are stored in a memory. These PB data also consist of same parameters as RT data except for ephemeris and Frame number of SPS stored data. Either the RT data or PB data (selected by ground command) are transmitted at a data rate of 16 Kbps after PSK modulation on 128KHz sub-carrier.

The HK data are sampled once in 32 seconds and consist of same parameters as RT data in addition to the health parameters of SPS.

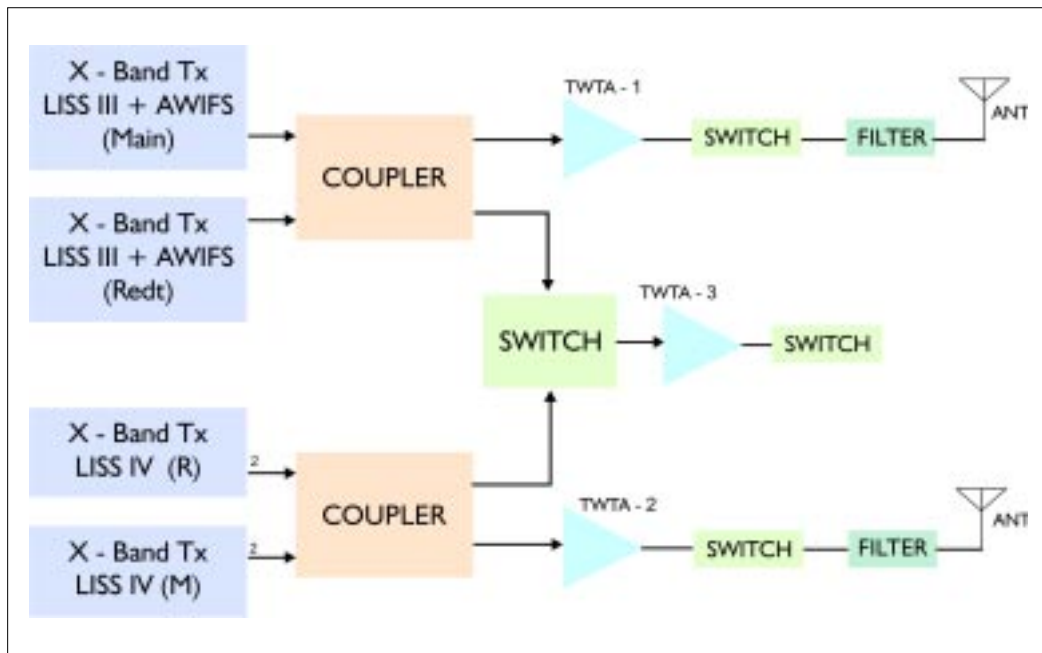

Fig 2.4.1 Schematic diagram of DH (RF)

3.1 GROUND SEGMENT OVERVIEW

The main functions of the Ground Segment are :

- Telemetry Tracking and Command
- Mission Control
- Data Reception
- Data products Generation and Dissemination
- Data Analyses

Telemetry Tracking and Command (TTC) functions are carried out by ISRO Telemetry Tracking and Command Centre (ISTRAC) with its ground stations located at Bangalore, Lucknow and Mauritius, with the selective support from space agencies of Europe, Russia and America. The

reception and recording of payload data are done at the earth station of the National Remote Sensing Agency (NRSA), located at Shadnagar, near Hyderabad. Mission Control support is provided from ISTRAC, Bangalore. Data is also transmitted to different International Ground Stations (IGS). The various elements of the IRS-P6 Ground Segment are given in Table 3.1.1 and the Ground Segment Organisation in Figure 3.1.1.

<i>Element</i>	<i>Location</i>	<i>Functions</i>
TTC	ISTRAC ground stations at Bangalore, Lucknow and Mauritius	<ol style="list-style-type: none"> 1. Satellite house keeping, data reception and recording 2. Spacecraft commanding and tracking
Mission Control	ISTRAC, Bangalore	<ol style="list-style-type: none"> 1. Network coordination and control 2. Scheduling spacecraft operations 3. Spacecraft HK data logging 4. Communication links between concerned ground segment elements
Data Reception	NRSA, Shadnagar	<ol style="list-style-type: none"> 1. Reception and recording of payload and OBTR data 2. Generation of browse imagery 3. Generation of ancillary data for product generation 4. Transfer of all data
Data products Generation, Dissemination and Analyses	NRSA, Balanagar	<ol style="list-style-type: none"> 1. Generation and distribution of different types of data products 2. Data quality evaluation, data and browse archival and management 3. Payload programming and request processing

Table 3.1.1 Ground segment elements and functions

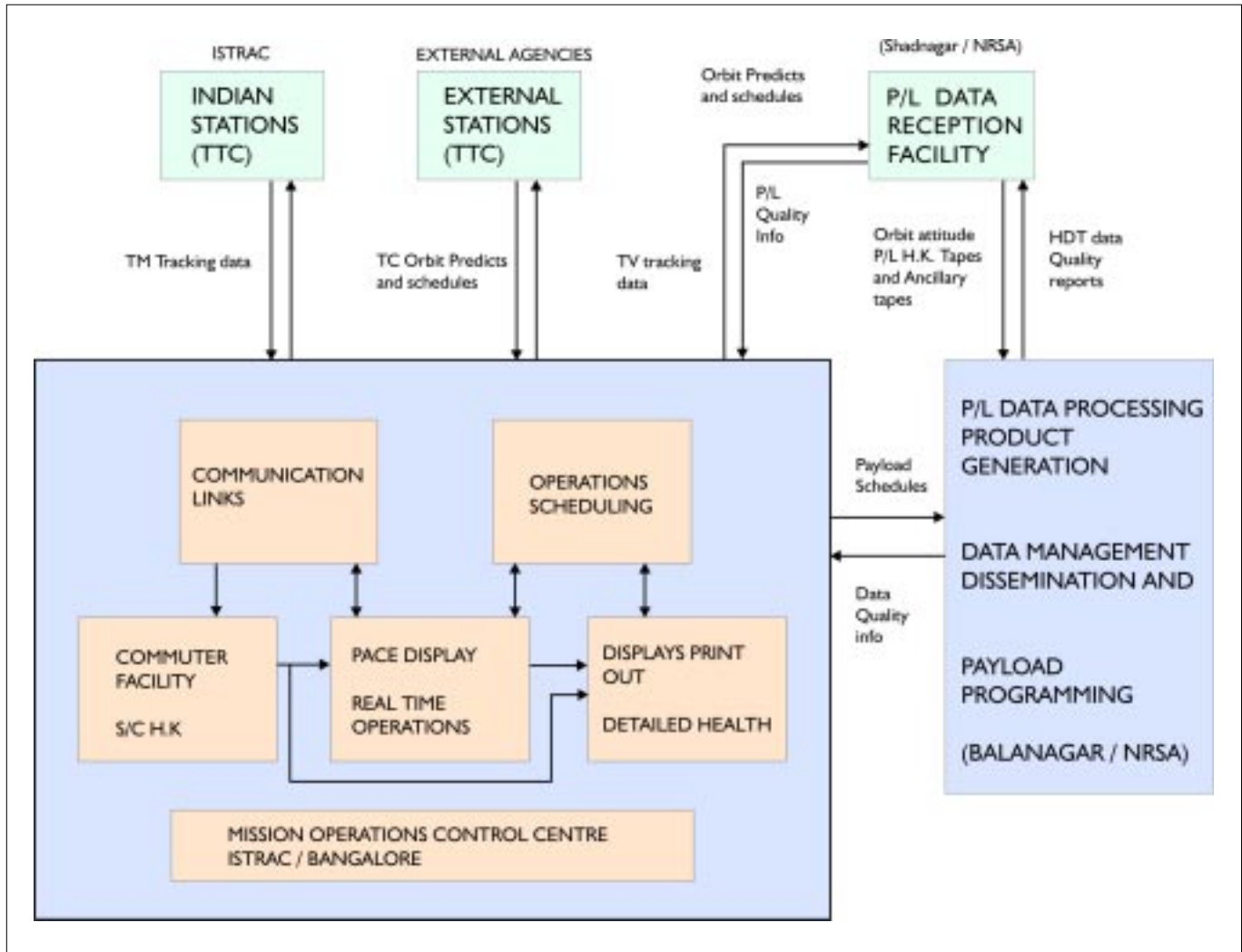

Figure 3.1.1 IRS-P6 Ground Segment organisation

3.2 TTC AND SPACECRAFT CONTROL CENTRE

3.2.1 Introduction

ISTRAC provides telemetry, tracking telecommand, spacecraft operations and control support for IRS-P6 mission through its network of ground stations, and Spacecraft Control Centre (SCC). SCC consists of mission control room, mission analysis room, simulation and training facilities, dedicated mission control room, computer facilities, flight dynamic operations and skyline communication facilities etc.,. TTC network comprises of a network of ground stations located at Bangalore (BLR), Lucknow (LCK), Mauritius (MAU), Bearslake (BRK) and Shriharikota (SHAR). A description of the various facilities of ISTRAC and their functional responsibilities with specific reference to IRS-P6 are provided in the following sections.

3.2.2 Spacecraft operations

The TTC network, Spacecraft Control Centre, data links and the operations team form the essential elements of mission control. In order to fulfill IRS-P6 mission goals, SCC with the support of ISTRAC network, carries out continuous health monitoring and control of IRS-P6 in the multi-mission operation environment. Along with this, SCC also schedules and carries out payload operations, viz., LISS-IV, LISS-III and AWiFS, SSR record/dump operations and SPS data collection. The five day revisit is achieved for LISS-IV through tilt operation. LISS-IV can be operated either in multi-spectral mode with reduced swath of 23 Km or Mono mode of selected band with 70 Km swath.

The spacecraft controllers at SCC interact through voice links with the TTC station to obtain telemetry & tracking support and uplink the scheduled commands during the radio visible segment of an orbit. SCC is equipped with the requisite mission software and display terminals to ensure error-free operations. These operations are carried out on a routine basis to keep the spacecraft in good health, intended orbit and orientation. Anomalies in a

spacecraft health and deviation in spacecraft attitude are tackled by spacecraft controllers by swift action, with the help of mission specific contingency operations management procedures. Ground stations carry out ranging operation collecting range, Doppler and Angles data in order to determine precise orbit for tracking the spacecraft by TTC stations and payload data reception stations.

ISTRAC ground stations located at Bangalore (BLR), Lucknow (LCK), Mauritius (MAU), Bearslake (BRK) and Sriharikota (SHAR) provide the support during initial and normal phase operations.

The ISTRAC functional organization for IRS-P6 mission support is shown in Figure 3.2.1.

3.2.3 TTC network

Spacecraft mission operations and control require a suitable network of ground stations to plan and execute appropriate telecommand operations on the spacecraft, as per pre-determined timeline. Ground station locations for IRS-P6 have been chosen on the basis of mission's sequence of events, mission strategies and sufficient radio visibility requirements of important arcs of the orbit.

3.2.4 TTC ground station configuration

ISTRAC TTC stations are equipped with almost identical systems for telemetry (TM) reception, tracking and telecommanding. All ground stations are installed with 10m antenna with a G/T of 19.5 dB. An acquisition antenna equivalent of 1m diameter, mounted on the main antenna system facilitates initial acquisition of the satellite. Capability to receive 3 or 4 TM carriers with necessary recording, PCM demodulation and quicklook facilities exist in all the stations. Each station is provided with a complete telecommand system of 2 KW RF power and high precision range and range rate systems. Each station has almost complete

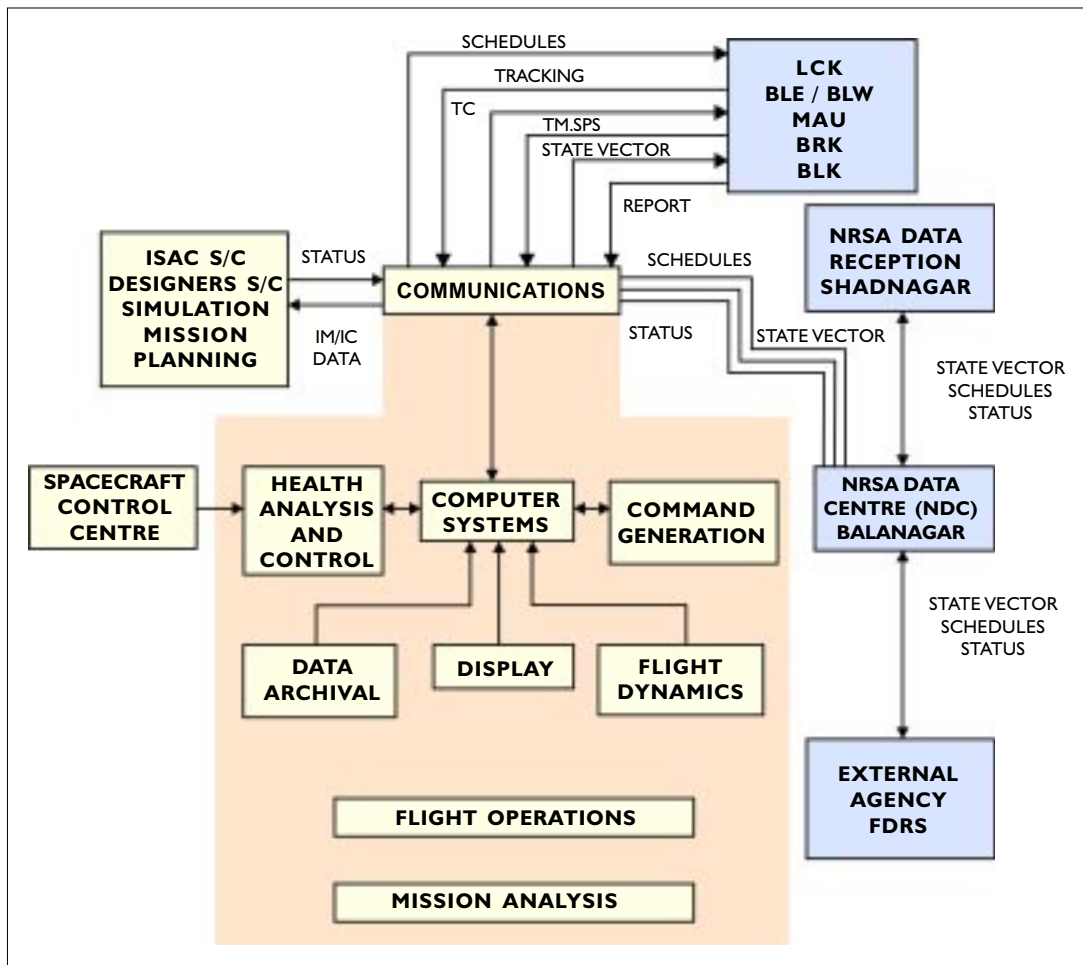

Figure 3.2.1 IRSTRAC functional organisation for IRS-P6 mission support

redundancy at all levels. Ground station computers send the data to mission computers at SCC for data processing. Important characteristics of ISTRAC network stations are given in Table 3.2.1.

In the IRS-P6 time frame, ISTRAC ground stations located at BLR, LCK and MAU will be equipped with new TTC processor as per ISTRAC network modernization programme.

The salient features of the new TTC processor are :

- ◆ A compact system which reduces the station size considerably.
- ◆ Single receiver built in the processor handles different types of modulations.
- ◆ Subcarrier frequency is tunable from 1 KHz to 1 MHz and data rate are also tunable to meet different mission requirement.
- ◆ Remote monitoring and control facility.

1.	Operating frequency	
	Receive	2200 to 2300 MHz
	Transmit	2025 to 2120 MHz
2.	Antenna	
	Size	10m(1m acq.)
	Gain/Temp	19.5 dB/deg K
	Velocity	9.0 deg/sec
	Acceleration	9.0 deg/sec ²
	Tracking mode	Auto/Program/CDM/manual
	Effective Isotropic Radiative power	> 70 dBw
3.	Modulation	
	Downlink	PCM/PSK/PM
	Uplink	PCM/FSK/FM/PM
4.	Timing Accuracy	100 micro secs
5.	Transmitter power	2 KW
6.	Tracking Accuracy	
	Angles	0.1 deg
	Range	10.0m
	Range rate	0.1 m/sec .
7.	Data Transfer	TCP/IP

Table 3.2.1 Characteristics of ISTRAC network stations

3.2.5 Functional requirement of TTC network

The functions of the TTC ground stations are:

- ◆ Housekeeping data reception in real time mode, dwell mode and play back mode
- ◆ SPS/Raw SS data reception and transmission to SSC computers
- ◆ Formatting and transmitting the data to SCC computers
- ◆ Transmission of commands generated at SCC to spacecraft
- ◆ Tracking the spacecraft and collecting range, doppler and angles data and transmitting to SCC for orbit determination.

The details of various support functions are given in the following sub-sections.

3.2.5.1 Telemetry

ISTRAC ground station(s) receives the down link signals from the spacecraft in real time and perform the following activities:

- ◆ Demodulate the signal
- ◆ Bit and Frame synchronize
- ◆ Time tag
- ◆ Format into standard blocks for transmission
- ◆ Record analog data for recall

3.2.5.2 Telecommand

Telecommand supports remote commanding in real time during ground station visibility. Commands can also be sent in local mode by entering directly at the SPICE end located at the ground stations and transmitted to the spacecraft.

3.2.5.3 Tracking

Tracking support is provided during any segment of the orbit during the visibility. Tracking support is provided simultaneously with telecommanding. The ground station measures range, range rate(doppler) and antenna angles of the spacecraft. This is essential for spacecraft orbit determination and ephemeris generation.

3.2.5.4 Data communication

Data communication links at ISTRAC establishes the required communication lines in coordination with the national and international agencies, to ensure transfer of telemetry, telecommand and tracking data using standard protocols. The TTC ground stations supporting IRS-P6 and SSC systems are interlinked continuously through dedicated skylinks using INSAT and INTELSAT satellites and ISDN links as backup.

3.2.6 Spacecraft Control Centre

The spacecraft Control Centre (SCC) located at Bangalore is the nerve center of all TTC and spacecraft control operations. IRS-P6 mission operations are conducted from SSC which is fully geared up with the necessary technical facilities for carrying out IRS-P6 spacecraft health monitoring, analysis and control. Mission Analysis Room (MAR), Mission Control Room (MCR) of SSC comprise of several observation consoles and command terminals connected to the computer facility for providing spacecraft health data to mission experts and mission operations team from pre-launch to end of initial phase. MCR is augmented with an elegant projection system to monitor launch events display and spacecraft ground trace. MAR is large enough to accommodate 18 work stations with improved facilities to cater to the launch and initial phase operations. All mission activities are carried out from Dedicated Mission Control Room (DMCR) of IRS-P6 in normal phase. SCC has several DMCRs which are restructured to handle many spacecraft missions simultaneously.

The major tasks of SCC are:

- ◆ Scheduling and execution of IRS-P6 mission operation tasks
- ◆ Planning and execution of orbit and attitude maneuvers as per mission requirements
- ◆ Orbit and attitude determination
- ◆ Scheduling of command operations as part of payload programming
- ◆ Housekeeping data monitoring in real time
- ◆ Spacecraft health data archival and database management
- ◆ Spacecraft health analysis and performance evaluation and reporting
- ◆ Co-ordination with various network stations, IGS, NDC and other related agencies to realize above tasks
- ◆ Anomaly identification and recovery action initiation in case of spacecraft emergencies along with mission experts.

3.2.6.1 Computer configuration for IRS-P6

A distributed computer system architecture is implemented at SCC, ISTRAC to support IRS-P6 mission during launch, initial and normal phase operations. This computer system supports IRS-P6 in the multi mission environment along with IRS-1C, IRS-P3, IRS-P4, IRS-1D and TES missions.

The computer configuration of IRS-P6 comprises of:

- ◆ Workstations for all processing and display of IRS-P6 spacecraft health data
- ◆ File servers/ Database servers for data management
- ◆ Bridge/Routers for interconnecting SCC to ISTRAC ground stations
- ◆ Gateway systems for interconnecting SCC to external agencies
- ◆ Virtual LANs for LAN connectivity of all the workstations communication processors, file servers, bridge / routers etc.,.

These systems operate continuously and concurrently with the existing computer systems which support on going missions. On these systems, a unified software system consisting of a set of layered software products catering to the functions of data communication, data management, data flow monitoring and inter system time synchronization are executed.

Figure 3.2.2 shows the computer configuration for IRS-P6 mission operations support.

3.2.6.2 Flight dynamics operations

Flight dynamics operations at SCC consists of:

- ◆ Processing the tracking data received from ground stations and determining the orbit
- ◆ Generations of the orbital events for scheduling and spacecraft operations
- ◆ Look angles generation for ground stations.

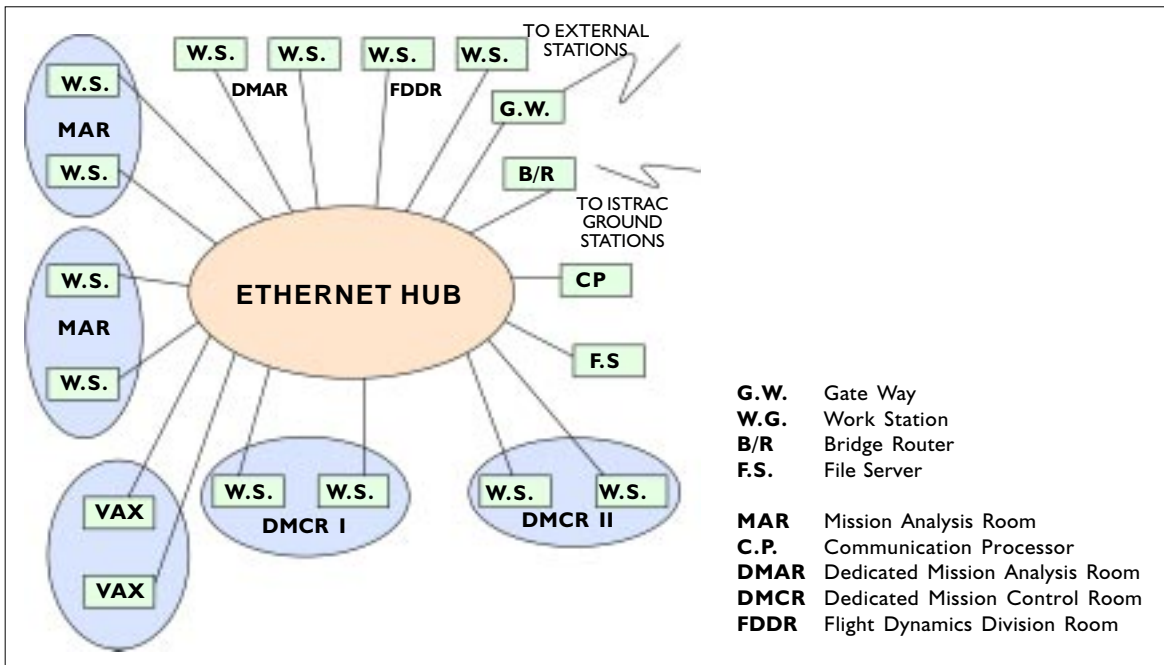

Figure 3.2.2 Computer configuration for IRS-P6 mission operations support

- ◆ Transmission of state vector to the users
- ◆ Attitude determination using various sensors data
- ◆ Orbit maintenance planning for stringent orbit control

3.2.6.3 Multi-satellite scheduling system

Effective TTC support is allocated to IRS-P6 in the multi-mission environment by ISTRAC Multi-mission Scheduling Software (MSS). MSS software was developed and operationalised at SCC. This MSS interfaces with payload programming system (PPS) in generating the operation schedules and command schedules for IRS-P6 along with other existing missions. MSS generates IRS-P6 schedule optimally by taking into account the following factors in the multi mission operations environment at SCC.

- ◆ Spacecraft specific requirements
- ◆ Spacecraft operations constraints
- ◆ Special operations requirements
- ◆ Network ground stations

- ◆ Ground stations configurations
- ◆ Visibility clashes

3.2.7 Payload Programming

Payload programming is a payload operation scheduling process which comprises of three major modules

- ◆ User order processing at NDC.
- ◆ Payload schedule generation at NDC
- ◆ Command schedule generation at SCC

The payload schedule received at SCC from NDC is scrutinized in the multi-mission operation environment and a confirmed payload schedule is derived in consultation with NDC for this confirmed schedule, command sequence is generated and unlinked to the space craft to cater the needs of payload user community.

ISO 9001 Quality management system is in place at ISTRAC for conducting IRS-P6 mission operations.

3.3 DATA RECEPTION STATION

3.3.1 Introduction

The data reception station at Shadnagar has two terminals to receive data from various remote sensing satellites like IRS-1C/1D, IRS-P4, IRS-P3, Landsat-5, ERS and TERRA. A new terminal with 7.5m diameter antenna system has been established to receive data from IRS-P6 satellite. The existing IRS terminal provides backup support in case there are no clashes with other satellites.

The Shadnagar ground station has the capability to track and receive data from any remote sensing satellite operating in S and X frequency bands of 2200-2300 MHz and 8025-8400 MHz respectively. The station receives payload data in X-band and house keeping and telemetry data in S-band.

3.3.2 Ground station configuration

The configuration of ground station for IRS-P6 data reception is shown in figure 3.3.1.

The system has the capability to do the following functions :

- * Satellite acquisition and tracking facility on S-band / X-band signals
- * Simultaneous data reception of LISS-IV and LISS-III + AWiFS data through two X-band carriers transmitted from IRS-P6 satellite
- * Real time data archiving and quick look monitoring of the data quality

3.3.3 Data Acquisition System

The following new elements are implemented in the data acquisition system of IRS-P6.

- * A 7.5 m diameter Antenna System of dual shaped reflectors with Cassegrain X/S Band feed provides higher efficiency and thereby G/T of 33 dB/deg

K to receive data in X-band from IRS-P6 and other remote sensing satellites.

- * A PC-based servo control system is used for auto tracking of the satellite together with Program Tracking System as back-up mode.
- * High performance digital demodulators are used for receiving LISS-IV, LISS-III and AWiFS data of IRS-P6.
- * PC-based Data Archival and Quick Look System has been provided as back-up for archiving and generating LISS-IV, LISS-III and AWiFS browse data of IRS-P6.

The data acquisition system comprises of the following major constituents:

Antenna System
Tracking pedestal
Servo Control System
Receiving System
Data Archival and Level-0 System

3.3.3.1 Antenna System

The dual shaped parabolic reflector is 7.5m in diameter and the focal length is equal to 3.077m. The reflector surface is made of sixteen single radial stretch formed panels. These panels are made of 1.6mm thick aluminum sheeting and stiffened by aluminum Zee sections (Z section 90 X 32 X 1.6) for all panels. The stiffeners are glued to the aluminum skin by commercially available glue.

3.3.3.2 Tracking Pedestal

The tracking pedestal consists of Elevation and Azimuth section. Each section is driven by two brushless servomotors which drive the respective turn tables through reduction gear boxes and slew ring bearings. The electro-mechanical brakes, tachometers, torque couplings, shaft encodes,

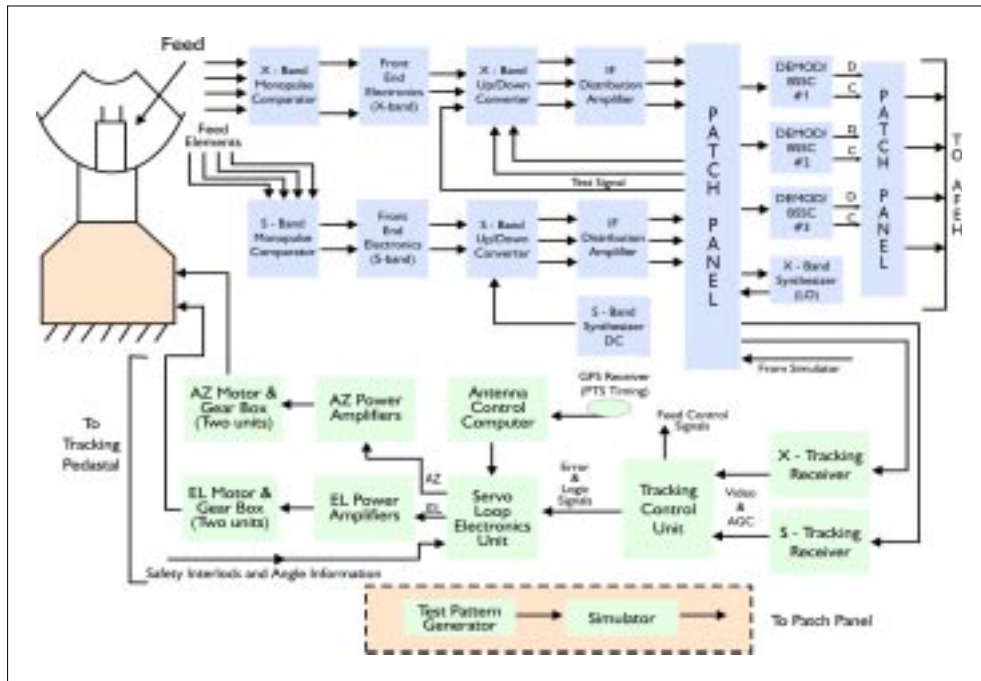

Figure 3.3.1 Block Diagram of Data Acquisition System



limit switch assembly, manual hand drives and stow locks are connected at appropriate locations in the drive train of each sections. Specifications of Antenna and Tracking Pedestal System are given in Table 3.3.1.

3.3.3.3 Servo System

The Servo Control System is a type-I/II system with high gain and wide servo band to meet the specification of high acceleration and precision

tracking accuracy. This system can be operated in different modes, which can be selected, from a PC in Remote mode and from the front panel of Servo Loop Electronics Unit (SLEU) in local mode. The automation of tracking operations is implemented in a computer including Program Tracking System. The Program Tracking System software facilitates the automation of the operations. The modes provided in local control are Standby, Manual rate and Auto Track.

Antenna type	Fully steerable with EL over AZ
Diameter (main reflector)	7.5 m shaped paraboloidal solid dish
F/D	0.41
Focal length	3.077 m
Feed type	Cassegrain
Overall RMS	
(a) Main Dish	0.6 mm RMS
(b) Sub-reflector	0.05 mm
Sky coverage	
(a) Elevation	-5° to 185°
(b) Azimuth	± 360° continuous
Speed	
(a) Elevation Axis	10° /sec
(b) Azimuth Axis	22° /sec
Angular Acceleration	
(a) Elevation Axis	2° /sec ²
(b) Azimuth Axis	10° /sec ²
Pointing Error	0.08° peak
Temperature	0° C to 55° C
Wind speed	
(a) Operational wind speed	60 Km/H
(b) Occasional gusting	80 Km/H
(c) Drive to stow	100 Km/H
(d) Survival wind speed in Zenith position	200 Km/H
Natural Frequency	5 Hz (preferably) but greater than 4 Hz.

Table 3.3.1 Specifications of Antenna and Tracking Pedestal System

<i>Tracking</i>	<i>S and X auto</i>
Pointing error	tracking with PTS as backup 0.08° peak
Position loop bandwidth	1 Hz
Rate loop band width	2.5 Hz
Tracking accuracy	±0.1° steady state. (for EL >88 will be higher)
Control type	Type – I / II
Angle read out accuracy	0.01°
Safety	Fail-safe electrical / mechanical brakes, Interlocks on stow pins and brakes
Natural frequency	4 Hz
Angle sensor	15 bit Absolute shaft Encoder.

Table 3.3.2 Specifications of Servo System

Brushless DC Servomotors are used which avoid the wear and tear of the brushes. The Power Amplifiers are IGBT based amplifiers, which generate the DC required for the motor to drive the antenna. The angle is sensed through optical shaft encoders, which are mechanically coupled to the antenna. Specifications of the Servo System are given Table 3.3.2.

3.3.3.4 Receiving System

IRS-P6 satellite transmits LISS-IV data and LISS-III + AWiFS data at 105 Mbps data rate using QPSK modulation scheme. Both data streams are transmitted through X-band carriers at 8125 MHz and 8300 MHz respectively.

The Shadnagar ground station Receiving System

Configuration	7.5 m high-efficiency dual shaped Cassegrain System
System G/T	X-band – 33 dB/°K S-Band – 19 dB/°K
Frequency Range	X-Band 8.025 - 8.400 GHz S-Band – 2.2 to 2.3 GHz
Type of tracking	Single channel Monopulse
Polarization	X-Band – RHC S-Band – RHC
Axial Ratio	1.5 dB maximum
IF frequency	720 MHz
Data rates	LISS-IV : 105 Mbps LISS-III +AWiFS : 105 Mbps
Carrier frequency	LISS-IV : 8125 MHz LISS-III + AWiFS : 8300 MHz

Table 3.3.3 Specifications of Receiving System

receives these signals through 7.5 m antenna system consisting of S / X band composite feed. The X-band signals are down converted to an IF of 720 MHz and S-band signals to an IF of 70 MHz. using synthesized down converter. The tracking receiver in the system amplitude demodulates the tracking signal IF consisting of tracking error information. The EL and Az DC errors are extracted in tracking controller unit and then fed to servo control system for tracking the satellite. Specifications of Receiving System are given in Table 3.3.3.

The down converted data signals are QPSK demodulated in ALCATEL QPSK demodulators and the output data and clock are fed to Data Archival and Quick Look Browse (DAQLB) through Advance Front End Hardware (AFEH) for further processing.

3.3.4 Data Archival and Level '0' System

IRS – P6 has two data streams at 105 Mbps. LISS-IV in one data stream and LISS-III + AWiFS in another data stream. It has a Solid State Recorder for Playback data with a recording capability in any one of the following modes.

- LISS-III + AWiFS data for 9 minutes and LISS-IV data for 9 minutes
- LISS-III + AWiFS data for 18 minutes
- LISS-IV data for 18 minutes

LISS-IV

The following are the two payload acquisition modes

- * Electronic scan mode covering 23.9 Km swath anywhere of 70.3 Km FOV in multi-spectral mode
- * Panchromatic mode covering 70.3 Km in red band alone
(The above modes can be operated with a roll tilt of +/- 26.0 deg.)

- * Calibration mode

LISS-III and AWiFS

There are two modes of acquisition :

- * Multi spectral mode
- * Calibration Mode

The payload can be programmed in any of the above payload acquisition modes for real time or for SSR recording. The SSR dump and calibration pass can be programmed during night pass.

3.3.4.1 Data Archival System

The major components of Data Archival System are the DAQLB Systems for Data Archival of payload data, Data Simulator for verifying pre-pass link checks, Data Path Controller (DPC) to route the data between Bit Sync Signal Conditioner (BSSC) and Advanced Front End Hardware Units (AFEH).

The Data Archival Systems for IRS-P6 (Figure

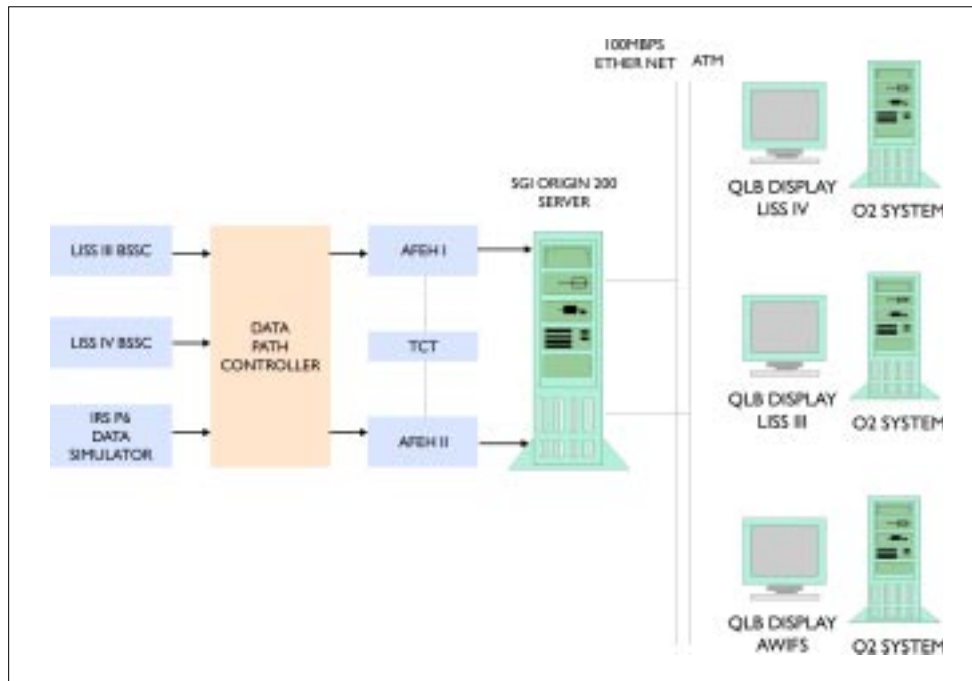

Figure 3.3.2 Level-0 DAQLB Archival System

3.3.2) consist of two Direct Archival Systems. The main DAQLB System is a SGI Origin based Server and the Backup System is a PC-based Server. Both are connected to RAID for raw data ingest. Base band data of two data streams, LISS-IV and LISS-III + AWiFS, are received at 105 Mbps each, in X-Band QPSK scheme.

The data from the main chain and backup chain are fed to Data Path Controller for routing the main chain data to the main DAQLB system and backup chain data to Backup DAQLB System. The data from four ports (for LISS-IV and LISS-III) of the DPC are fed to DAQLB systems, along with IRIG-A time code, for archiving raw payload data in real-time.

The data and clock from BSSC in real-time along with IRIG-A time code are fed to the Advanced FEH units (AFEH-1 and AFEH-2). These AFEH units are connected to DAQLBs through Ultra SCSI. AFEH does frame synhronization and word synchronization on the incoming payload data and transfers the raw data to the RAID system connected to DAQLB in real-time. Later a FRED format DLT is generated for both the streams (LISS-

IV and LISS-III + AWiFS) as permanent archival media. Level-'0' QLB software does the de-randomization and de-commutation on raw payload data in real time for auxiliary data extraction and FCC browse display of LISS-IV, LISS-III and AWiFS sensors.

3.3.4.2 DAQLB Systems

The DAQLB system in its full configuration is connected to fiber channel RAID for archival of LISS-IV and LISS-III + AWiFS in real time with Quick Look and Browse Archival facility.

The DAQLB main system (Figure 3.3.3) consists of Origin 200 Giga Channel server Fiber Channel Interface, GPIB interface (IEEE-488), SCSI interface, Digital Audio Tape (DAT) and Digital Linear Tape (DLT) devices, two AFEH units and a Time Code Translator.

The backup DAQLB System (Figure 3.3.4) consists of PC Server with the above interfaces.

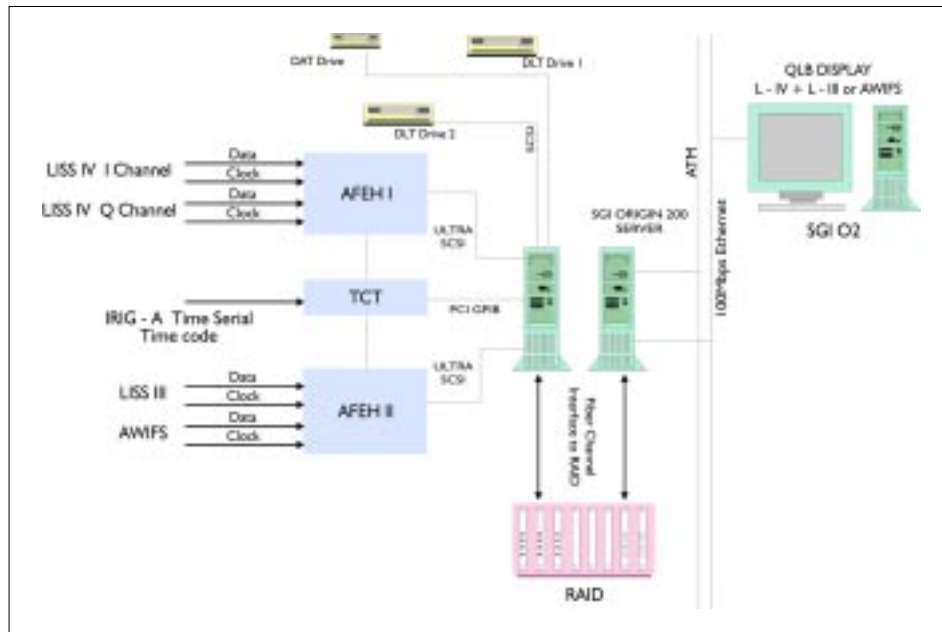

Figure 3.3.3 Level-0 DAQLB (Main) Archival System

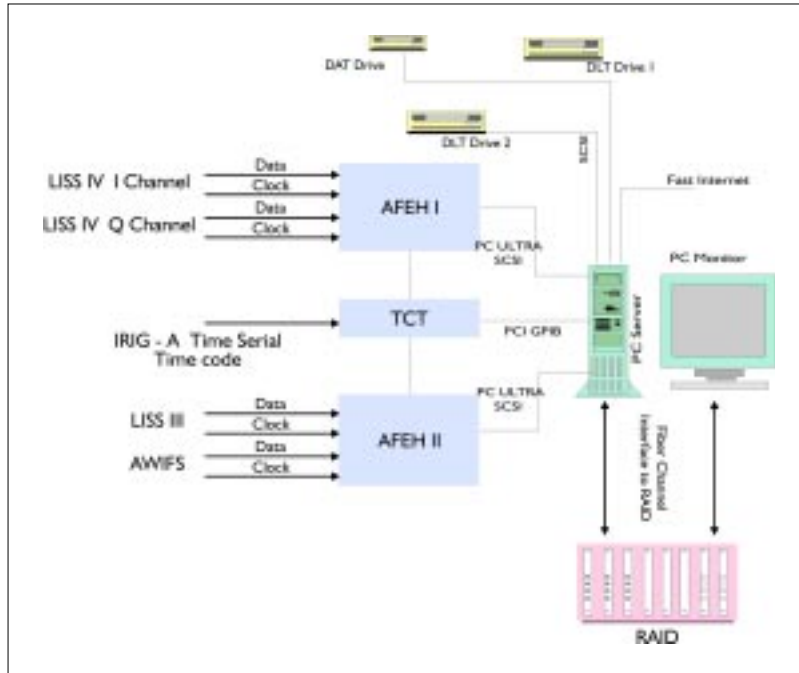

Figure 3.3.4 DAQLB System (Backup) configuration

During real-time for payload passes, the AFEH provides raw data along with GRT to DAQLB through Ultra SCSI Interfaces, for both the streams. The quick look browse module of Level-'0' software does raw data archival on RAID volume, Aux data extraction and FCC browse display for LISS-IV and LISS-III in real time. After the real time pass, the telemetry master frames are constructed and validated from auxiliary data.

From SCC, state vectors are received from two sources. One is from normal S-band and other is from SPS G mode. At Level '0' SPS G mode, state vectors are used for product generation when the SPS orbital accuracy is better than S-band state vectors. In addition to these modes SPS - L mode data embedded in payload HK data is experimented in initial phase. In this mode, state vectors are derived from the passes scheduled and used in product generation minimizing the product Turn Around Time (TAT). In addition to this, SPS data acquisition in S band is planned at Shadnagar to make the station autonomous for Sate Vectors. Attitude determination is done with constructed

telemetry frames using Earth Sensor data. This information along with ancillary information including data quality, line count is used for generating Ancillary Data Information File (ADIF). Compressed browse images are generated from raw browse data and transferred on network to Browse Archival System at Balanagar. ADIF is also transferred to IMS over network. DLT in FRED format, is generated from RAID and sent as final product.

Night pass operations include CAL and SSR PB. For CAL passes, on-board calibration data is archived on DAQLB in real time for the specified sensor. The DAQLB system extracts auxiliary data and displays CAL pattern in real time. Telemetry master frame construction, selected cycles calibration diskload and transfer on network to CAL DQE system are also performed.

For SSR-PB, raw data archival, extraction of Auxiliary data, FCC browse display, OBT-GRT correlation, telemetry master frame extraction, ADIF generation, FRED Formatted DLT

creation are the post pass activities.

Pass	Mode	Raw data Archival	ADIF	Browse
Day	LISS-III/DLT + AWiFS LISS-IV (Mono) LISS-IV (Mx) SSR Day		Network	Network
Night	SSR CAL	DLT DAT	-	-

3.3.4.3 Network systems Intranet

The Intranet at Shadnagar (Figure 3.3.5) is configured around Fast Ethernet and ATM. All Real time computer systems and supporting non-real time systems are connected to this network through DEC multi-switch network backbone with network handling capacity of

1Gb/sec. The network switch has the capability to support connectivity for network elements of 10 base Ethernet, 100 base Ethernet, ATM and Routers. This Intranet is connected to SPACENET via Routers for Balanagar and SCC, ISTRAC Interface. Two servers are dedicated for this purpose one handling SCC and the other, NRSA Balanagar, network transfers.

Spacenet

The Level ‘0’ computer systems transact with various work centers to exchange critical information for meeting the requirements of Level ‘0’ product chain (Figure 3.3.6). The transactions include exchange of information as follows via spacenet :

- From Spacecraft Control Center to Level ‘0’ system:
- State vectors
- Attitude bias values
- General schedules
- SCHEMACS display pages during initial phase of launch

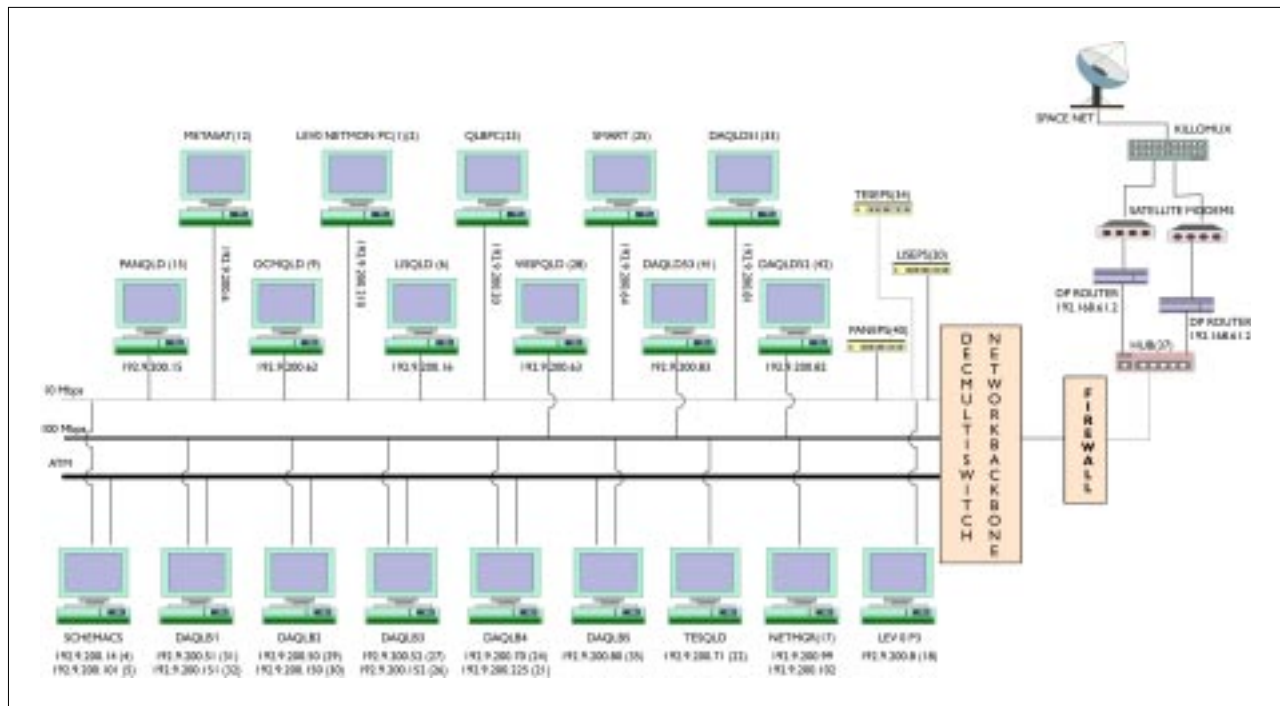

Figure 3.3.5 Network configuration at Shadnagar Earth Station

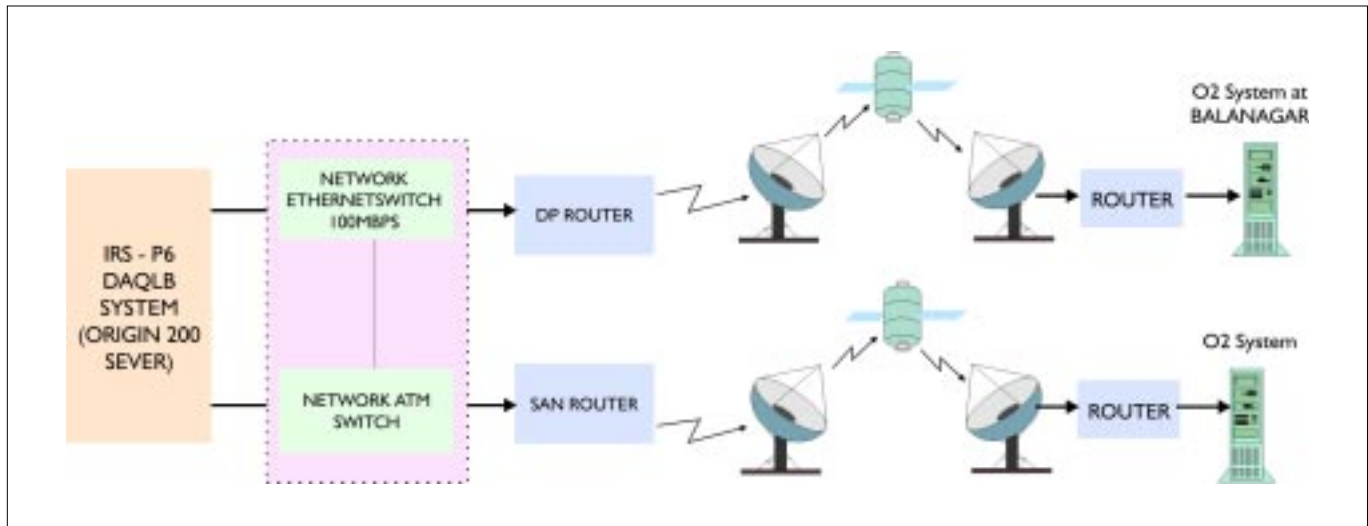

Figure 3.3.6 Level-0 network connectivity

From Level ‘0’ system to Spacecraft Control Center (SCC) :

- Attitude Telex reports
- Attitude plots
- JPEG compressed images

From Level ‘0’ system to Data Processing Facilities, Balanagar :

- LISS-III and LISS-IV - RT and SSR ADIF to IIMS
- LISS-III, LISS-IV browse data of RT and SSR to Browse Archival System
- CAL analysis data to DQE

Software for Network Transfers

The Level ‘0’ products like ADIF and Browse for all IRS missions and MSMR raw data for IRS-P4 are transferred to the Data Processing Center at Balanagar via SPACENET.

The files are first transferred from individual DAQLB workstations to Network Server. These files are then transferred to NRSA DP server by FTP. All these events happen for every Sensor/Mission

asynchronously and it is highly laborious to do it manually. Therefore Network monitoring utilities are developed to handle the above transfers, to check the status of network, disk space availability at DP server end and file transfer status. Software also logs the transfer status into the database for reference and report generation in auto mode.

3.3.4.4 Level ‘0’ Information System

Level ‘0’ Information System is a server based web enabled program, which provides a data base for all Level ‘0’ operation for the mission on a daily basis. The program is developed around Client/Server environment. The Server program contains the basic logic for database management. The Client side program caters to the pre-processing of user inputs before uploading to Server. This reduces the load on Server and also the right information is also updated. A shell script program is developed to post-process the ADIF information to extract AOS, LOS, Data On/Off, other relevant pass information, data quality etc.,. The script generates an interface file that is used by the Server program as base data for the given date of operation. This software has been augmented with utilities such as Monthly progress, weekly progress reports, Sorting based on

problems, etc.,. Automatic system generated Level'0' reports on daily basis is a novel concept to provide non-subjective, error free and dependable report for satellite control team at ISTRAC, for mission management team at ISAC, data processing team at NRSA, SAC and other decision makers.

3.3.4.5 Timing Systems

Ground station and real time Data Archival System work on the UTC. Timing facility (Figure 3.3.7) is one of the critical elements of the total acquisition and processing system. The station time is maintained precisely with respect to Universal Time (UT) using Global Positioning System (GPS) Receiver. This is achieved by means of Time code generator (TCG), which is driven by a precision oscillator. The TCG is synchronized with respect to GPS receiver every day, and produces IRIG-A time with accuracy better than a few microseconds.

3.3.4.6 Data Path Controller

Data Path Controller (DPC) is a high speed switching matrix (16 x 16) to route the serial digital data and its clock to various real time systems from the Reception Systems. The unit is developed using VLSI technology and it works upto 350 Mbps. The data and corresponding clock are routed simultaneously as a set. The unit can be programmed to route both data and clock from any of its input ports to any of its output ports. Any single input can be routed to more than one output ports. The required connectivity can be established by configuring the unit in any one of the following modes.

Front panel with user friendly keypad and LCD

Remote configuration through GPIB

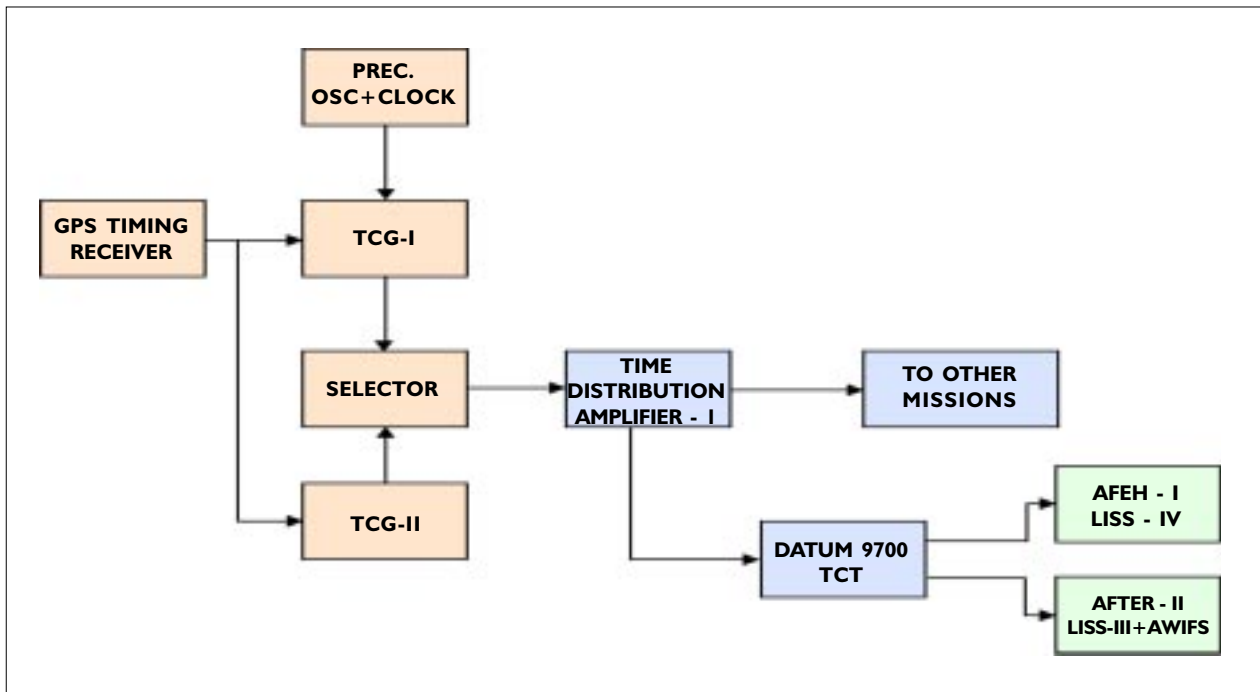

Figure 3.3.7 Level-0 Timing System

3.3.4.7 Data Simulator

The IRS-P6 Data Simulator is a standalone system that simulates LISS-III, AWiFS and LISS-IV sensor streams. It simulates the line count, mode flags and video patterns. Five different video patterns can be programmed for LISS-III and AWiFS sensors. For LISS-IV, all electronic scanning formats are programmable in multi-spectral mode. Frame sync error injection facility is provided for all the streams. IEEE-488 interface is provided to upload external auxiliary data from computer. This mode facilitates more realistic pre-launch simulation tests with ground checkout auxiliary information.

The Data Simulator supports an additional PN-sequence generator (PRBS) mode. In this mode, PN-sequence of selected code length is generated at sensor bit rate. This mode is useful in receive chain BER performance evaluation.

3.3.4.8 S-band SPS Data Acquisition System

To make Shadnagar Station autonomous, SPS data in S-band chain @ 16 Kbps data rate is archived on a PC-based Data Acquisition System (Figure 3.3.8). The SPS state vectors in G mode are derived through SANGAM software and used in Level '0' product chain. The system was developed in-house. The system acquires SPS data in S-band chain at 16 Kbps data rate. The raw data is ingested in real time to the system disk. The format of raw file is compatible to SANGAM software requirement.

3.3.4.9 Backup Management System

The Level '0' systems handle the image data and the mission parameters. The mission parameters need to be managed for mission life for every satellite. Hence the backup management is one of the important and critical tasks of real time systems.

The data from these operational files are required for future reference for ADIF regeneration, mission analysis, product/software problem analysis etc.,.

The Level '0' product for any IRS mission contains, apart from raw data in FRED format, auxiliary data, orbit information, attitude data, browse data, data quality information and ancillary data information for every sensor of the respective satellite. Therefore, the above data is backed up on a daily basis after the Level'0' product is generated for every sensor.

Daywise incremental backup is taken up from disk to RAID. After one week of backup on RAID, the data is transcribed onto DLT media for permanent storage. Hence on any day, previous one week data is readily available on RAID disk for immediate usage. In real time systems, system backup management is mandatory to maintain high system availability and hence system backups are taken at regular intervals.

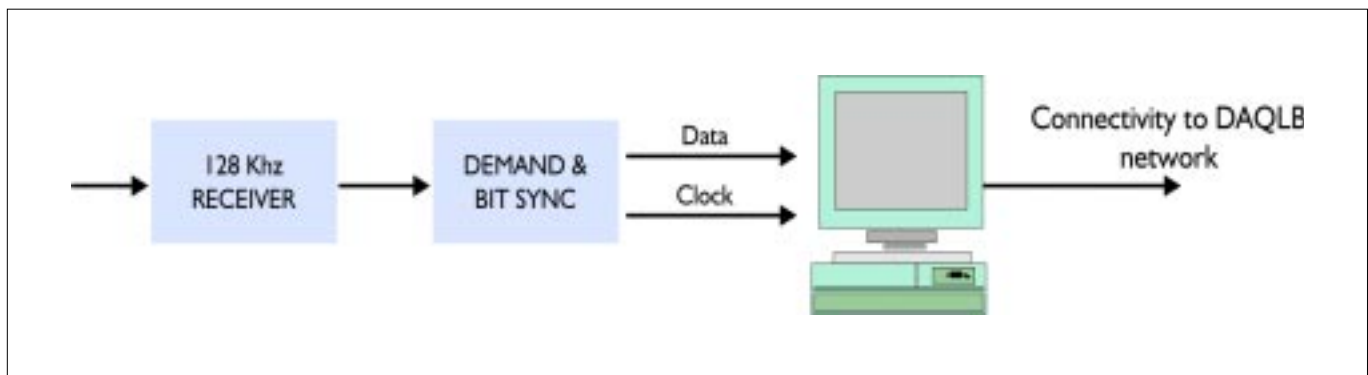

Figure 3.3.8 SPS data acquisition system

3.4 DATA PRODUCTS GENERATION FACILITY

3.4.1 Introduction

IRS-P6 Data Processing and Data Products Generation System facilitates generation of various types of data products in digital and photographic formats as per users requirements. A catalogue of all the data acquired, alongwith cloud cover and quality information is obtained and maintained in an Integrated Information Management system (IIMS) for easy retrieval.

In order to meet the demand for IRS-P6 data products and the existing data products, the facilities have been augmented to achieve improved throughput and better performance and reliability. Some of the benefits of augmentation are

- * Near real time Browse generation at the ground station, Shadnagar using DAQLB System, ensuring browse availability on the same day of acquisition.
- * Browse data access to users through Internet and Intranet Web browsers and Dial-up lines.
- * Archival of raw data on Digital Linear Tapes (DLT), for better storage.
- * Powerful data processing systems with very highend graphics to provide quality checks and reliable data products with high throughput.
- * High volume data transfers through network between work centers.
- * Creation of GCPs in various resolutions for improving geometric and location accuracy in the data products.
- * Transfer of the generated data onto the required output media like CD-ROM, 8mm DAT, 4mm DAT media etc.,.
- * Data processing for generation of Value added products like Precision products, Merged products, Ortho rectified products and Stereo products generation for DEM models.
- * Photo products generation, which includes photo writing from digital media to photographic prints.
- * Data Quality checking of digital, master films and photo products.
- * Data Quality Evaluation (DQE), for monitoring the sensor and platform behaviour.
- * Integrated Information Management System (IIMS) for management of products generation and dissemination activities.

The major functions of IRS-P6 Data Products Generation Facility are

- * Archival of raw data on DLTs for better storage.
- * Archival of all payload data, alongwith their corresponding ancillary information.
- * Data processing and data product generation which comprises of raw data ingest, data correction for radiometric, geometric errors and resampling.

NRSA Data Center (NDC) interacts with users, processes user indents, monitors and distributes the data products. All the user requests are processed and monitored using IIMS, which connects all production centers. All the user accounts and data supply information, are maintained in IIMS.

3.4.2 Data Processing Systems

Data Processing Facility comprises of SGI Octane and O₂ workstation based Systems and a PC-based System. Further, SGI Octane and O₂ based data processing systems are configured as two data processing chains.

- 1) Data Processing Chain –1 (DPC-1)
- 2) Data Processing Chain –1 (DPC-2)
- 3) PC Based AWiFS Data Processing.

These Chains DPC-1 and 2 are envisaged for the use of generation of all types of data products and Special products. Data from different sensors of IRS-P6 are processed at the data processing system alongwith the other satellite data.

The block diagram of the DPC 1 and 2 is given in the Figure 3.4.1.

The functions of each chain are :

- * Work Order Generation
- * Data Ingest
- * Data Processing
- * Data Outputting

Work Order Generation

The user work order inputs are validated through NDC-IMS-DPS interfaces. Workfile is created using ancillary information from IIMS database.

Data Ingest

The raw data of different sensors of IRS-P6 is downloaded from the DLT media, for the required number of scan lines from the given start time and the disk file is created for the required scene.

Data Processing

Downloaded raw data disk file is processed for radiometric and geometric corrections

- * Radiometric corrections are applied to correct non-uniform detector responses.
- * Geometric corrections take care of satellite platform parameters (i.e., attitude, altitude), earth rotation and curvature related variations.
- * The image is resampled further to obtain radiometric and geometrically balanced image, free from losses.

Data Outputting

Data thus generated is transferred on to desired digital media. Intermediate data for Photo product generation are dispatched to Filming work center for filming. The completed data products are updated as work order completed to Digital Quality

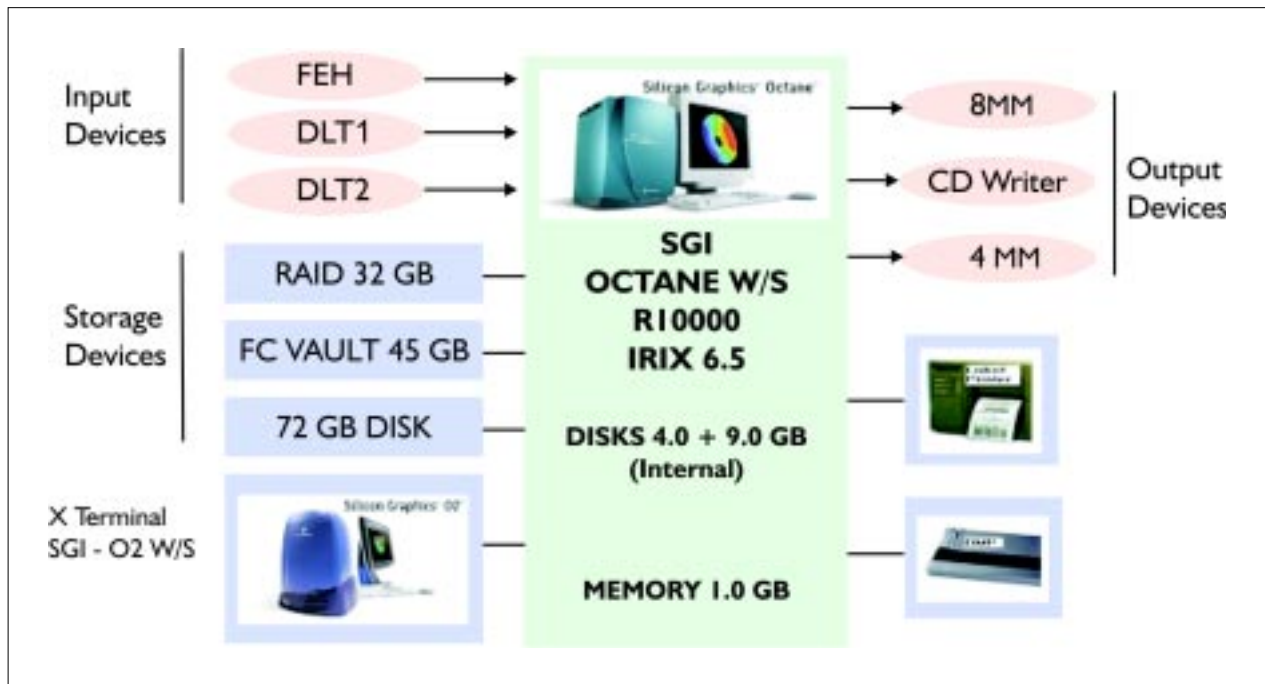

Figure 3.4.1 Configuration of Data Processing system

Control for data quality check from where only good quality products are dispatched to the user from NDC.

Scheduling strategy for Data processing Chain Systems – 1 and 2

User order request queuing by NDC to DPS Chain 1 and 2 is automated through IIMS as and when the DPS Scheduler requests for work order. DP scheduler automates the processes one after the other to obtain the desired output product media. The following are the functions of the Scheduler:

- ◆ Normal request queuing:
- ◆ System capability to generate specific product.
- ◆ Priority request handling
- ◆ Merging of multiple products of the same scene.
- ◆ Batching of multiple media products for the same scene.

- ◆ Out of turn assignment for urgent products
- ◆ Queuing based on completion or operator's request.

PC-Based AWiFS Data Processing System

The AWiFS data processing is done on a Dual Xeon processor based PC Server system. This is a standalone system exclusively for processing data from AWiFS sensor. In view of the large amount of data to be processed in the case of AWiFS, a separate system has been identified to achieve better turn around time. The block diagram of PC based AWiFS Data Processing System is shown in Figure 3.4.2.

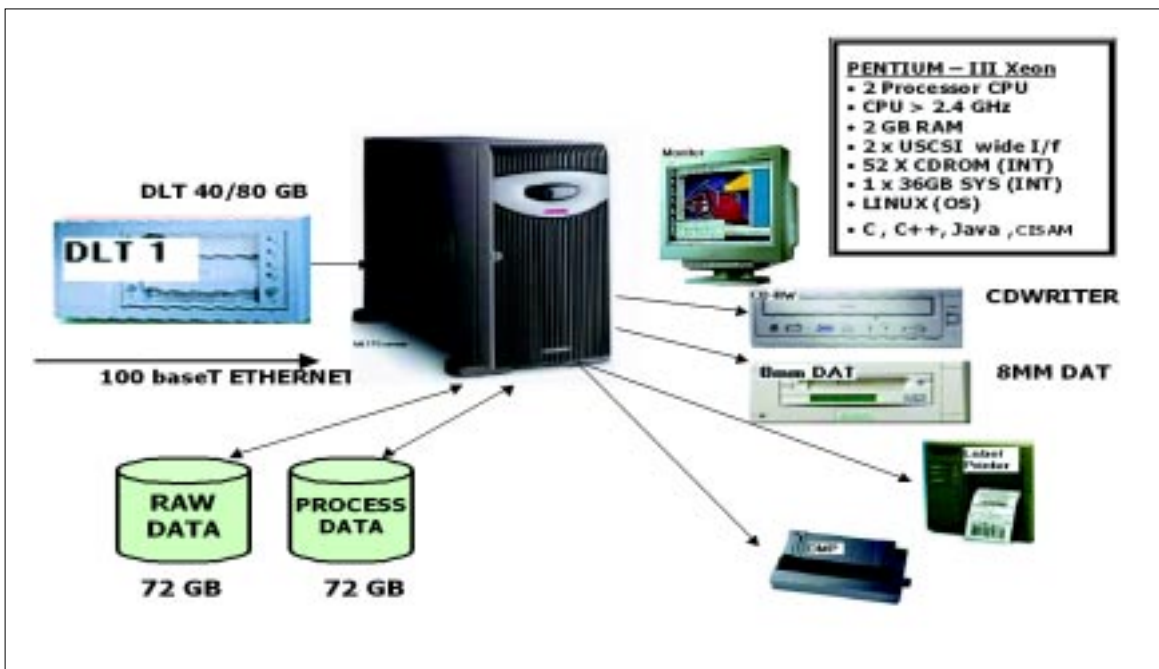

Figure 3.4.2 Configuration of PC - based AWiFS Data Processing system

3.5 FILMING SYSTEMS

3.5.1 Introduction

The Filming System is a centralized facility for generating B/W and color master films / photo prints for all satellites and sensors. Photographic products are generated directly on a 40" x 40" B/W or color photographic paper or on a 240mm B/W / color negative film.

The filming system consists of two separate facilities:

1. Large Format Filming System (LFFS)
2. Small Format Filming System (SFFS)

3.5.2 LFFS

In Large Format Filming System, large scale outputs can be obtained, by directly writing digital data on 40" x 40" B/W / color paper. In conventional reproductions, due to the diffusion effect, the minor details are lost, giving rise to poor modulation transfer function. Whereas, in digital image generation on Large Format Film Recorder (LFFR), as each pixel is exposed separately and directly, higher MTF is achieved and first generation product is supplied to user.

Linear gamma Look Up Tables are used for correcting non-linearity of photographic paper, photo processing and Photowrite characteristics (Figure 3.5.1).

The existing LFFR supports only B/W prints generation. The upgradation of LFFR is under progress for writing directly onto 40" x 40" color paper. The functional diagram is shown in Figure 3.5.2.

3.5.3 SFFS

The Small Format Filming System (SFFS) is capable of generating 10" x 10" films. The B/W and color photo products of all satellites /sensors are

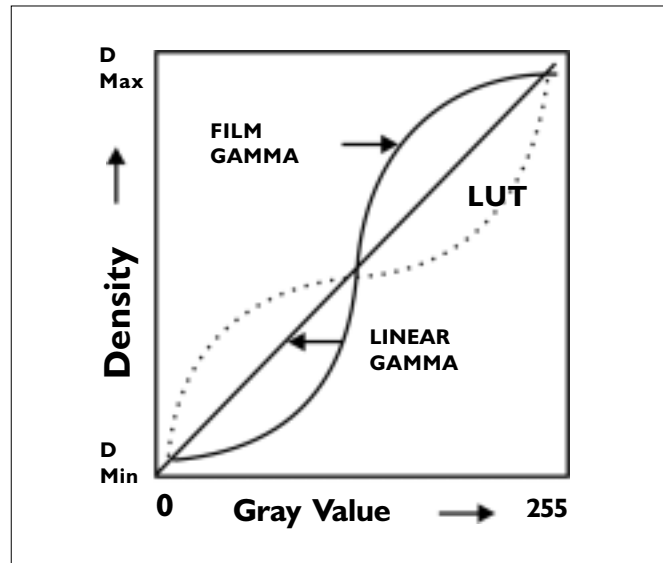

Figure 3.5.1 Film gamma correction

generated on 240mm B/W or color film on SFFS in the backup mode.

Types of photo products supported

- B/W and color paper (40" X 40")
- B/W and FCC negative film (10" X 10")

Product generation overview

At the filming system, the image data alongwith the IIMS work order for film / photographic paper is received from DPS / VADS through network file transfer / CD-ROM / 8mm DAT media. The data is displayed in the ingest system and necessary scene based LUT enhancements are carried out interactively on Image Processing Systems and applied to the data. A test target is filmed in each batch of paper / film roll batch to confirm the performance of the film recorder. Before filming, the image is displayed to check and minimize the rejection of the print due to data related problems. Paper prints / films are generated as per priority in IIMS work order and dispatched to the Photo

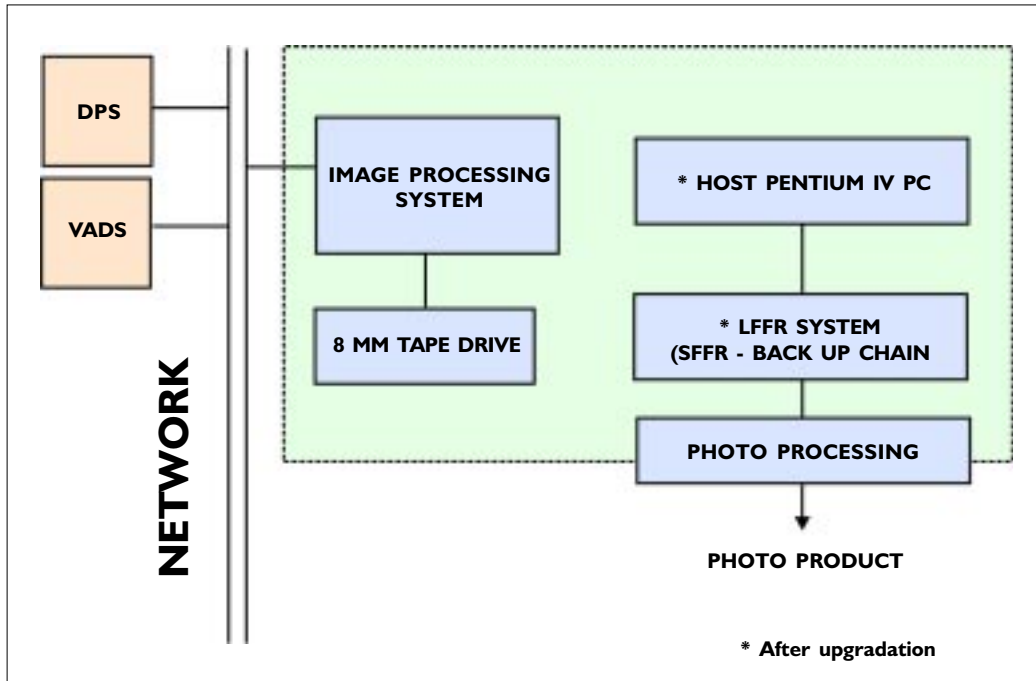

Figure 3.5.2 LFFS network configuration

Processing Facility for further processing. After processing, they are dispatched to Quality Checking cell which inspects the print/ film quality etc., and in case of any rejection due to filming problems, they are re-filmed and sent for photo processing.

3.6 PHOTO PRODUCTS GENERATION SYSTEM

The Photo Processing laboratory is responsible for master film processing and generation of all B&W and color photo products in the form of paper prints. It is equipped with modern photo processing and printing systems. The facility is tailormade to meet the stringent quality requirements of satellite photo products as required by users. The lab has:

- ◆ B/W and color Master film processors
- ◆ Photographic Printers and Enlargers
- ◆ B/W and color processors
- ◆ QA and QC systems
- ◆ Sensitometric lab
- ◆ Chemical analysis lab

Exposed films are processed in the B/W and Color film processors and the master films are sent for

quality check at the Quality Control Centre. The film products which qualify the quality criteria are routed back to the photolab for printing. Photolab takes the workorder from Integrated Informatin Management System (IIMS), draws the required masters from film archives and generates the photo products as per the job order. The final products are sent for quality check to quality control workcentre. Photo processing system has a number of in-built, in-process-control checks to ensure and assure quality outputs. For this purpose sensitometric and analytical support facilities are also available. The functions of various photographic systems used for photo products generation are given in Table 3.6.1.

Figure 3.6.1 shows the photo processing work flow of various data products.

<i>Name of the system</i>	<i>Function</i>
Versamat film processor- I/II	B/W master film processing
Kreonite / Colenta C-41 film processor	Color master film processing
HK contact printer I / III	B/W 1x print generation
HK 677 / 877 AF enlarger	B/W enlargement
Hostert / Colenta B/W paper processor	B/W print processing
HK Contact printer – II / III	Color 1x print generation
Durst 2000 / 2501 AF enlarger	Color enlargement
Kreonite / Colex RA-4 color paper processor	Color print processing

Table 3.6.1 Functions of various photographic processors

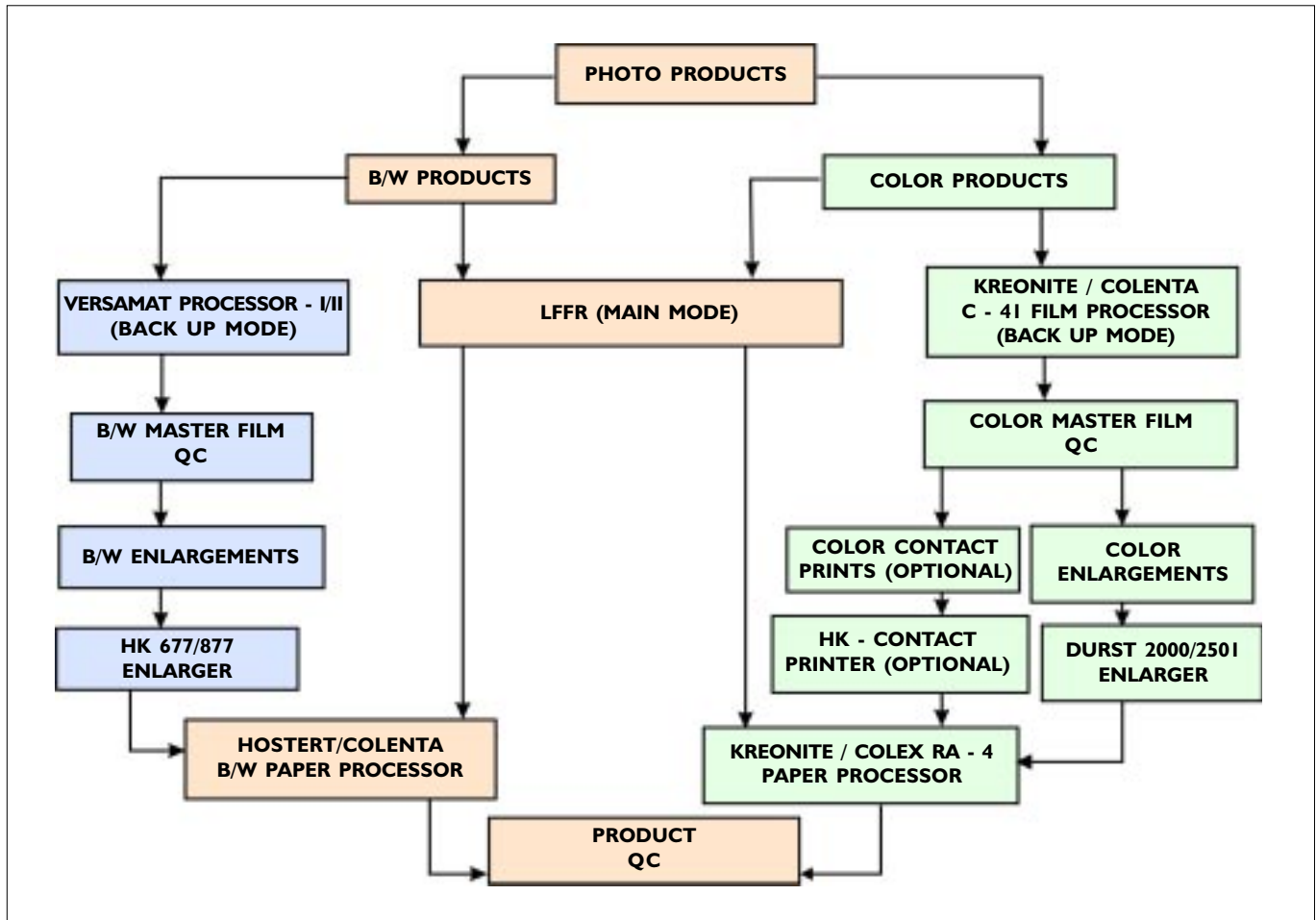

Figure 3.6.1 Photographic products generation flow

3.7 QUALITY ASSURANCE

It is ensured that only good quality data products are sent to the users. Both digital and photographic data products are checked for a set of pre-defined quality criteria prior to supply to the users. The photo products are inspected for data processing and filming / photo processing problems.

3.7.1 General criteria

- * Products should be free from severe vertical striping
- * Scattered pixel drop outs should not affect more than 5% of the total image area
- * Data loss should not exceed one scan line
- * There should not be any image distortion affecting the continuity of data
- * Data should free from noise related artifacts.
- * Geometric quality should be as per the specifications

3.7.2 Photo products criteria

By default, all B/W and color photo products are generated in Large Format Fotorite System (LFFS) and the Small Format Filming System (SFFS) is used as a backup chain. Specifications of the photo product masters generated in backup mode are provided in Table 3.7.1. All the photo products are visually inspected and graded as accepted and rejected. The rejected products, depending upon the type of problem, are put back to either DPS for regeneration or to filming for refilming or to NDC for an alternate date. All photo products should conform to the following criteria:

- * Film Recorder problems such as micro banding, seating problem, recorder lines, fog, scratches etc., should not affect the interpretability of the image and aesthetic quality of the image.

Parameter	B/W	FCC
D Max	1.75 ± 0.10	0.95 ± 0.05
D Min	≤ 0.15	0.25R, 0.65G, 0.85B
Colour Balance	--	≤ 0.05D at 0.60D above B+F
Linearity of gray scale	≤ 6% of D max	≤ 8% of D max
Density uniformity	≤ 0.08 D at 0.80D above B+F	≤ 0.05 at 0.6D above B+F
MTF	≥ 75 % at 17 cycles/mm	≥ 60% at 17cycles/mm
Physical Dimension	≤ 0.1 %	≤ 0.1%
Registration	—	Half pixel

Table 3.7.1 Photo masters specification (Backup mode)

- * Photo processing defects such as roller marks, scratches, fog, dust, finger prints etc., should not affect the interpretability and aesthetic quality of the image.
- * There should be sufficient image contrast and density so that the photographic products can be interpreted easily.

Specification of photo prints (Products)

Parameter	B/W	FCC
Dmax	≥ 1.90	≥ 2.30
Dmin	≤ 0.15	≤ 0.15
Colour Balance	—	≤ 0.1D at 1.0 D
Physical dimension	≤ 0.15%	≤ 0.15%

3.7.3 Digital product criteria

Digital products should conform to the following :

- * Digital products should be free from physical damage and be readable in a system other than the one available in the production unit.
- * Conform to radiometric and geometric quality specifications
- * Digital product should conform to NRSA digital product format document.

The flow chart for generation of digital products is given in Figure 3.7.2

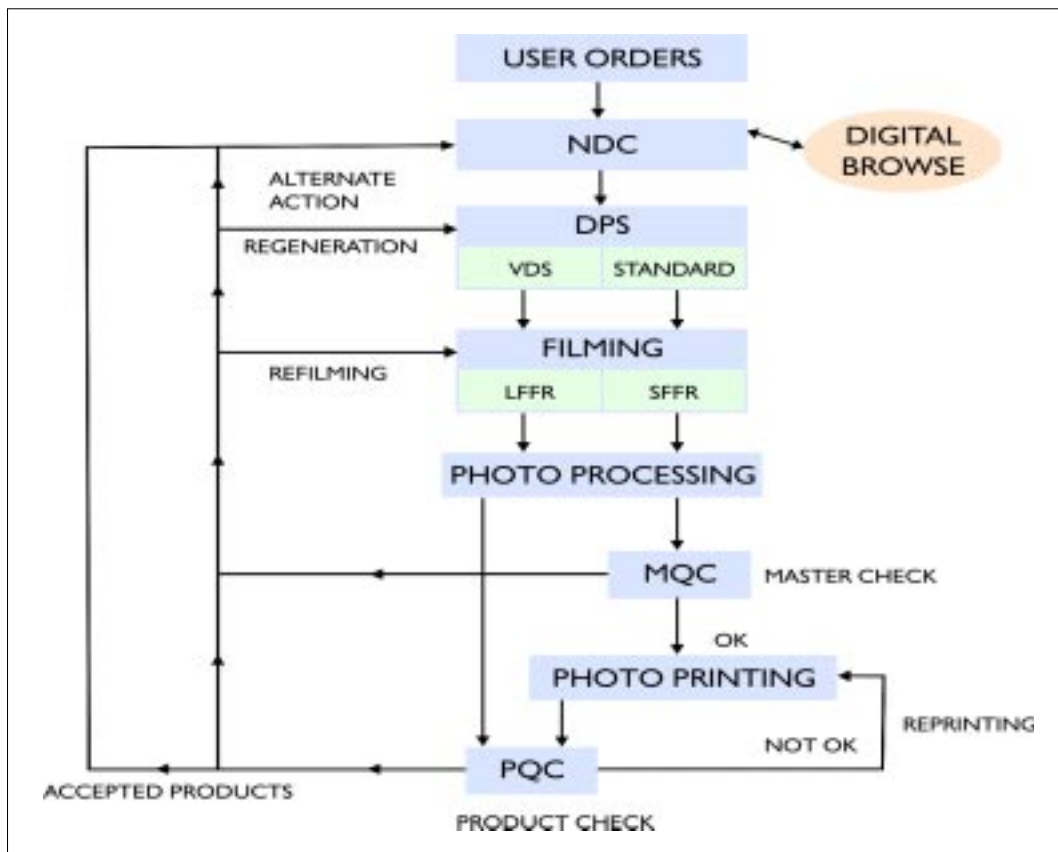

Figure 3.7.1 Flow chart for generation of photo products

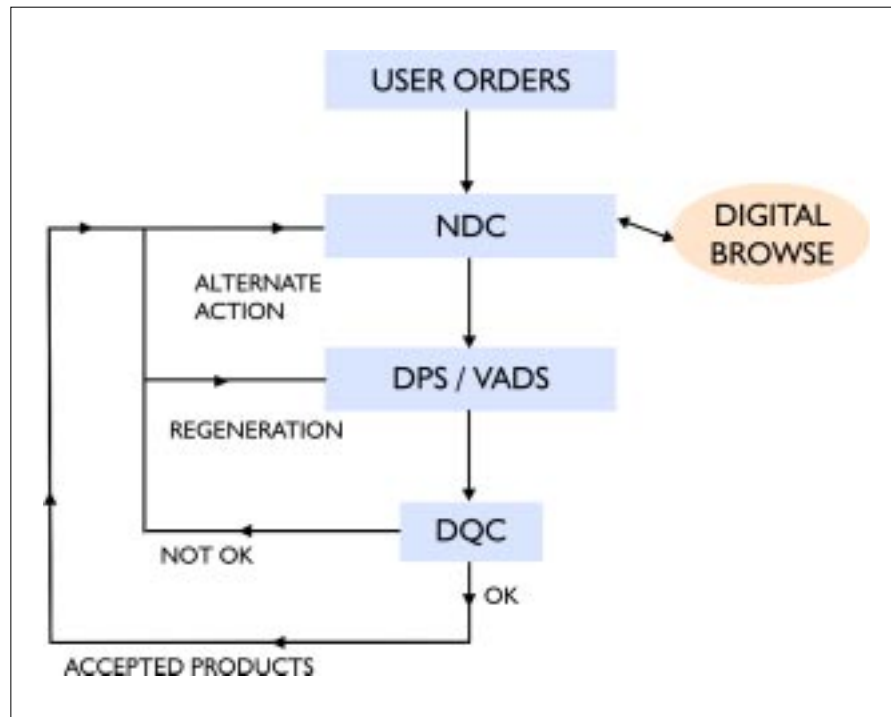

Figure 3.7.2 Flow chart for generation of digital products

3.7.4 Value added products criteria

All value added products like merged, precision geocoded and ortho products are checked for the following in addition to the above criteria :

- * Misregistration, mosaicing problems
- * Noise related artifacts.
- * Area coverage
- * Data format as required by the user

3.7.5 Geometric Data Quality Control (GDQC)

Appropriate checks are made to ensure the location accuracy for IRS-P6 digital products. Geometric Data Quality Checking System (GDQC) consisting of a Digitizer interfaced with DQC system is used for this activity. Digital products which meet the location accuracy specifications are certified to be of good quality. A certificate to this effect is issued alongwith each product. Figure 3.7.3 shows the

layout of GDQC hardware interface.

3.7.6 QC Certificate

All accepted digital products are supplied to users with a QC certificate. The certificate consists of the scene details and data quality rating, with remarks. The format of the QC certificate is given in Figure 3.7.4

3.7.7 Screening and validation of sensitive areas/ masking in LISS-IV products

As per the guide lines provided by the Ministry of Defence, India, sensitive areas in all products with 5m and/or better than 5 m. resolution are masked before supplying to the users. Some extra area masking is done as appropriate, to account for the location inaccuracy. LISS-IV standard and merged products are validated at QC and certified before dispatch to users.

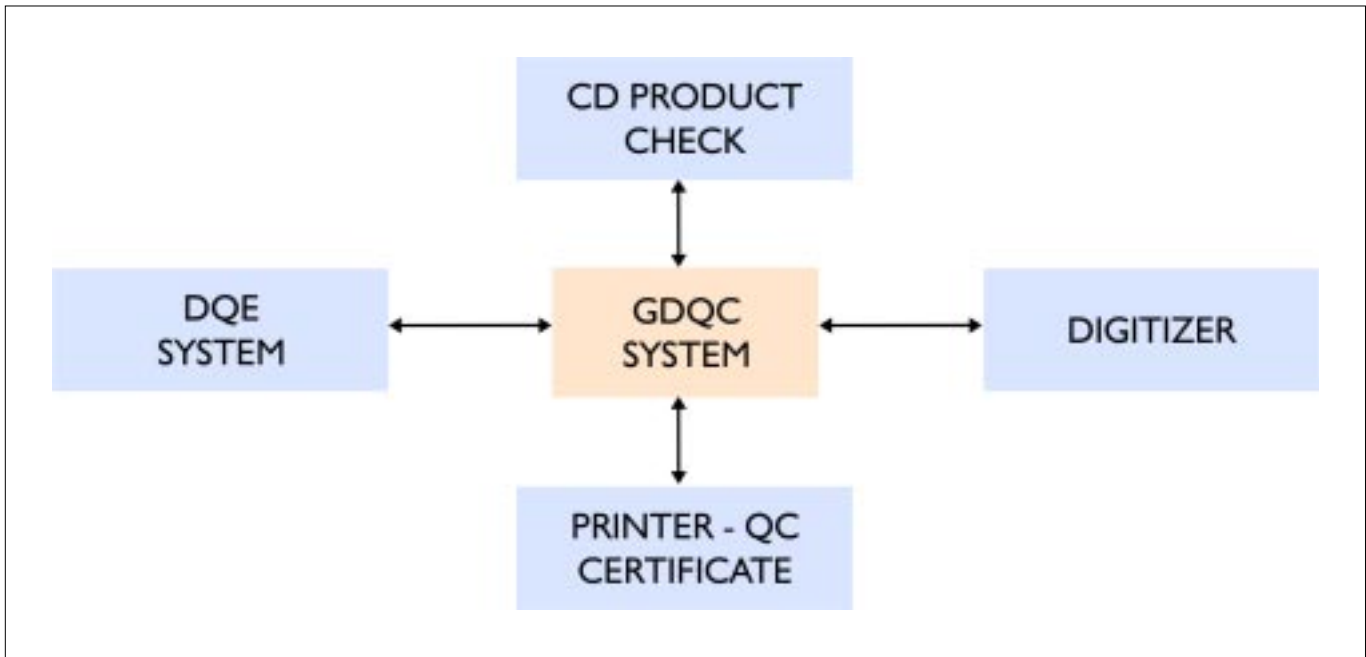

Figure 3.7.3 GDQC hardware interface layout

**NATIONAL REMOTE SENSING AGENCY
PRODUCT QUALITY CONTROL CERTIFICATE**

Req. No.	Account No.	Media:
Format :	Product Type:	
Scene Details :		
QC Rating :	Remarks :	
Geometric Accuracy :		
Rejections :	QC Date :	

Figure 3.7.4 Format of QC certificate

3.8 DATA QUALITY EVALUATION

The performance of the mission is evaluated at the Data Quality Evaluation System, for optical sensors. This requires the following aspects of to be quantified:

- * Multi-sensor data sets with different spatial resolution at different wavelength with different bandwidth.
- * Platform sensor performance (coarser and precise) of attitude / orbit sensor with correct knowledge.
- * Impact of payload / platform knowledge uncertainty on user product generation system,
- * Evaluation of user products accuracy, processed to different levels like raw, radiometrically corrected and Standard.

DQE can be broadly classified into :

Radiometric DQE (RDQE)
Geometric DQE (GDQE)

3.8.1 DQE parameters

Data quality evaluation parameters are defined to qualify and quantify radiometric / geometric accuracy achieved on user product. These parameters are evaluated for every cycle sensor data acquired at the ground station. The various DQE parameters are classified with respect to payload, platform stability and user data product. These parameters are evaluated by radiometric and geometric software packages. In order to evaluate DQE parameters, the following data files are required for computation and comparison.

- * Lab measured sensor calibration coefficients using standard source for converting measured digital count to radiance
- * Saturation radiance for all spectral bands
- * Ground control point co-ordinates (latitude,

longitude, mean sea height) with video chip and image-map as reference library

- * Lab measured band to band registration, detector array overlap
- * Payload alignment angle with respect to Master Reference Cube (MRC).
- * LED based onboard calibration data for detector characterization

RDQE is done in two ways, namely,

Calibration analysis
Scene related analysis

For calibration analysis, calibration data is obtained from the satellite during night pass. This onboard calibration data is compared with ground reference data. The parameters used in evaluation are :

1. Standard error between the on-board calibration data and ground reference data.
2. Temporal error between two successive on-board calibration data.
3. Dark current levels
4. LED status

In scene related analysis, spectral response of the sensor is evaluated by comparing spectral signature of various known terrains viz., desert sand, river sand, vegetation, water, barren land, urban area and snow at different sun elevation angles.

GDQE is done to evaluate the following parameters:

1. Location accuracy of data products
2. Band to band misregistration
3. Internal distortions in a scene.

3.8.2 DQE software package

The various DQE parameters are computed by the respective radiometric and geometric software packages. The various tasks performed by each

package are as follows:

CALDQE : Analyses pre-launch laboratory measured and post launch satellite transmitted onboard Calibration data

RDQE : Analyses of scene based radiometric parameters

GDQE : Handles payload and orbit/platform/user product related geometric parameters

Database: ORACLE based storage of DQE results and report generation for analysis

Scheduler : Schedules multiple DQE requests at operations center

CAL/VAL : Calibrates and validates optical sensor

3.8.3 Reference Database Generation

The DQE parameters are computed using GCP/target position in the given product as input. Hitherto, a video GCP chip generated using IRS-1C/1D LISS-III/PAN data was being used for GDQE. During IRS-P6 time frame a reference image-map database using IRS-1C/1D LISS-III/PAN images with rectified corner coordinates is being constructed as reference.

Figure 3.8.1 shows the screen layout for GCP Id when reference is video chip.

Figure 3.8.2 shows the screen layout for GCP Id when reference is LISS-III/PAN image, with rectified corner coordinates.

3.8.4 Histogram based detector port performance analysis

The IRS-P6 DQE system has provided the necessary software at Shadnagar Earth Station DAQLB to monitor histogram based detector port

performance and generates summary results on the same day of data acquisition (Figure 3.8.3). The following were taken as the basis for algorithm development.

The sensor consists of detector array and optics, which form the image. The alternate detectors of an array are connected to different ports, such that separate ports control odd and even detectors. Alternate detectors of first 3000 will be connected to two separate ports. In mono mode, all eight ports' histogram from a single band will be evaluated. The multi-spectral mode operates with electronic switching where in any 4K detectors of all three bands out of the 12K can be operated, which may result in more than two ports getting covered in a single line. Thus, only the adjacent port comparison is carried out for port performance evaluation. Given below, is a typical port configuration of LISS-IV.

1 to 3000 Detectors	P1 P5 P1 P5
3001 to 6000 Detectors	P2 P6 P2 P6
6001 to 9000 Detectors	P3 P7 P3 P7
9001 to 12000 Detectors	P4 P8 P4 P8

Analyzing the odd and even detector performance can help evaluate the performance of ports. The detector port performance evaluation package of DQE system uses the port histogram of a set of lines to evaluate the health of port.

Predefined rules are applied on the parameters, to evaluate the port performance and generate an alert to mission about any deviation alongwith details like date, time of pass and sensor with port number.

It may be noted that the Cmax and Cmin parameters are selected corresponding to first occurrence of frequency, which meets the 'Limit', where 'Limit' is a predefined percentage of total frequency.

The list of rules and corresponding port-performance anomaly are listed below:



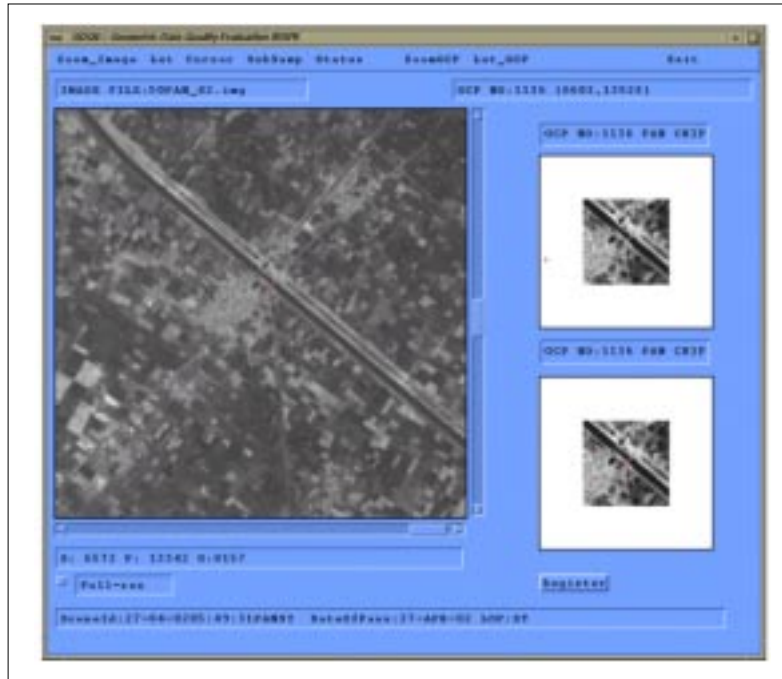

Figure 3.8.1 Screen layout for GCP Id when reference is video chip



Figure 3.8.2 Screen layout for GCP Id when reference is LISS-III / PAN image with rectified corner coordinates

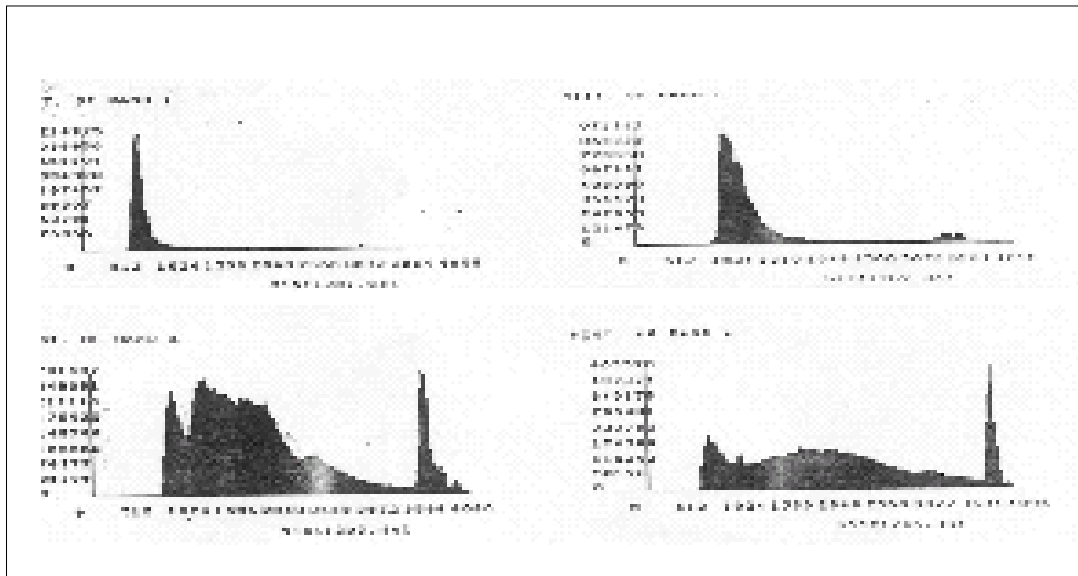

Figure 3.8.3 Scene histogram of all 4 bands of LISS-III sensor
X – axis : Digital Count y-axis: Frequencies

1. Indication of the trend of Port behavior: Non-zero but less-than-limit frequency for all sets indicate the tendency of port to malfunctioning
 2. Flagging of inter-port identical behavior: Exact match of all parameters for all sets is flagged for identical behavior of ports.
 3. Indication of port failure: The frequency corresponding to zero count equals the total frequency indicating port failure
 4. Flagging of inter-port behavior : Assuming that the even and odd parameters will be same within tolerance limits, any deviation (20% for count and 10% for frequency) is flagged as deviation observed.
 5. Confirmation of trend in frequency domain
 6. Inter-band comparison : Dynamic range of different bands are compared to isolate the anomaly in any one band.
1. **Selection and procurement of suitable target material:** The target material to be used for calibration activity requires should have temporally stable radiometric properties. The parameter-based design requires the material to be modular and easy to handle.
 2. **Development, characterization and maintenance of calibration site:** Unlike laboratory, the calibration site has relatively less controlled environment and requires to be characterized for its dimensions using GPS, reflectance property using Spectroradiometer and local atmosphere using Sun photometer. Its terrain requires periodic maintenance to keep it free of unwanted vegetative growth etc.,.
 3. **Design of parameter specific targets:** Various engineering and radiometric parameters are identified for this activity and the targets are designed and deployed accordingly. This activity is feasible due to high resolution of sensors like PAN.

3.8.5 Calibration and Validation activity in DQE system

This is an in-house activity of DQE System. This activity involves:

4. Calibration of instruments and development of algorithm :

Before ground truth is carried out the calibration of instruments needs to be ensured. Algorithm for computation of parameters, atmospheric correction and software needs to be developed.

5. Ground measurement: During satellite pass, synchronous ground measurement of target radiance, target reflectance and atmospheric parameters is carried out. Ground measured radiance is corrected for measured atmospheric absorption and scattering. The computed radiance is compared with sensor measured radiance. Calibration and validation for 1m and 5m resolution panchromatic sensor is successfully being carried out. A procedure has been developed for IRS-P6 LISS-IV camera where spatial resolution is nearly 5m with multi-spectral capability.

A Test Site of 300 m x 300 m with bare soil is developed and maintained at North Cot Cattle farm, Chharodi, about 35 Km west of Ahmedabad (Figure 3.8.4). The parameter-based design of artificial Targets of different reflectivity is prepared and targets are deployed prior to satellite pass. Synchronous ground truth is carried out using Analytical Spectral Devices and Sun Photometer/Ozonometer to measure target radiance, reflectance, atmospheric optical depth and solar irradiance reaching to ground.

Parameters

Following are the parameters of the CALVAL activity:

1. The prime parameter is the validation and if required, updation of calibration coefficient
2. Verification of scene dynamic range using high through low reflecting targets

Sensor Id	Band	Gain/Exp	SatRad	
LISS-IV	2	1	58.45	
	3	1	45.87	
	4	1	37.01	
LISS-III	2	1	27.0	
		2	18.819	
		3	14.092	
		4	9.089	
	3	1	27.472	
		2	18.396	
		3	16.408	
		4	10.27	
	4	1	31.642	
		2	21.003	
		3	17.647	
		4	10.914	
5	1	6.976		
	Exp		A	B
	2	7	62.5	59.6
		8	53.7	52.18
3	9	48.1	46.42	
	8	52.13	44.89	
	9	46.4	39.88	
4	10	41.67	35.93	
	7	36.11	32.37	
	8	30.87	28.38	
	9	27.29	25.15	
5	1	6.78	6.81	

Table 3.8.1 Saturation radiance values at various Gains/Exposures

3. Measured target radiance/ reflectance
4. Computed target radiance/reflectance
5. Path radiance and optical depth
6. Square Wave Response (SWR).

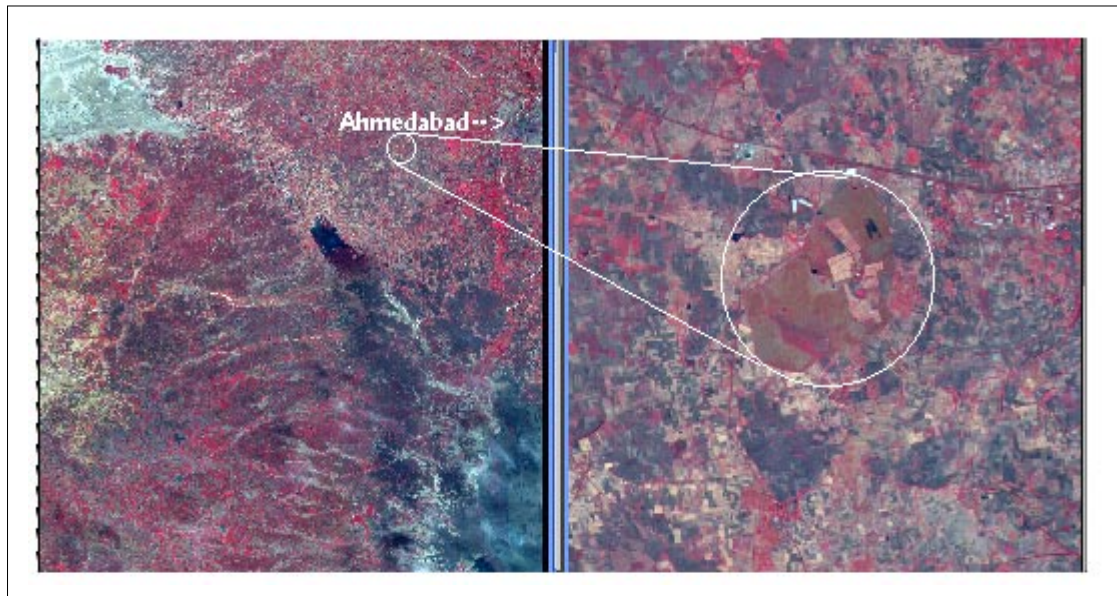

Figure 3.8.4 North Cot Cattle farm, Chharodi as viewed by LISS-III

7. Modulation Transfer Function (MTF) / Effective Resolution Element (ERE) at different contrast.

8. Ground sampling Distance (GSD).

Methodology

Following methodology is adopted :

- ◆ Synchronous Measurement of target reflectance and radiance of natural / artificial targets.
- ◆ Synchronous measurement of atmospheric optical depth and solar irradiance.
- ◆ Measurement of temperature and humidity.
- ◆ Computation of MTF/ERE at different contrast.
- ◆ Computation of measured target radiance and reflectance for LISS-IV camera bands.
- ◆ Computation of target radiance and reflectance after correction of atmospheric effect.
- ◆ Comparison of corrected and measured radiance.

3.9 INTEGRATED INFORMATION MANAGEMENT SYSTEM

The Integrated Information Management System (IIMS) is a management tool for controlling the work flow of the data processing activity. It automates the total production chain right from the work order generation till the despatch and invoicing of the products generated. It is an integrated system handling the entire satellite data product generation. IIMS manages the accession information of all the satellites.

IIMS system is built around Compaq ES 40 Tru UNIX servers. The configuration of the IIMS system is given in Figure 3.9.1.

The main functions of IIMS are :

- * Management of the acquired data
- * Generation of accession catalogue
- * Proforma processing
- * User order / request processing
- * Priority of data products generation
- * User accounting / billing management
- * Various reports for monitoring the production status of the products
- * Dynamic scheduling of data requests to a system
- * Updation functions for each work center
- * DLT / films archives management
- * Production management
- * Accounting in Indian and Foreign currency
- * Statistics on data usage by users

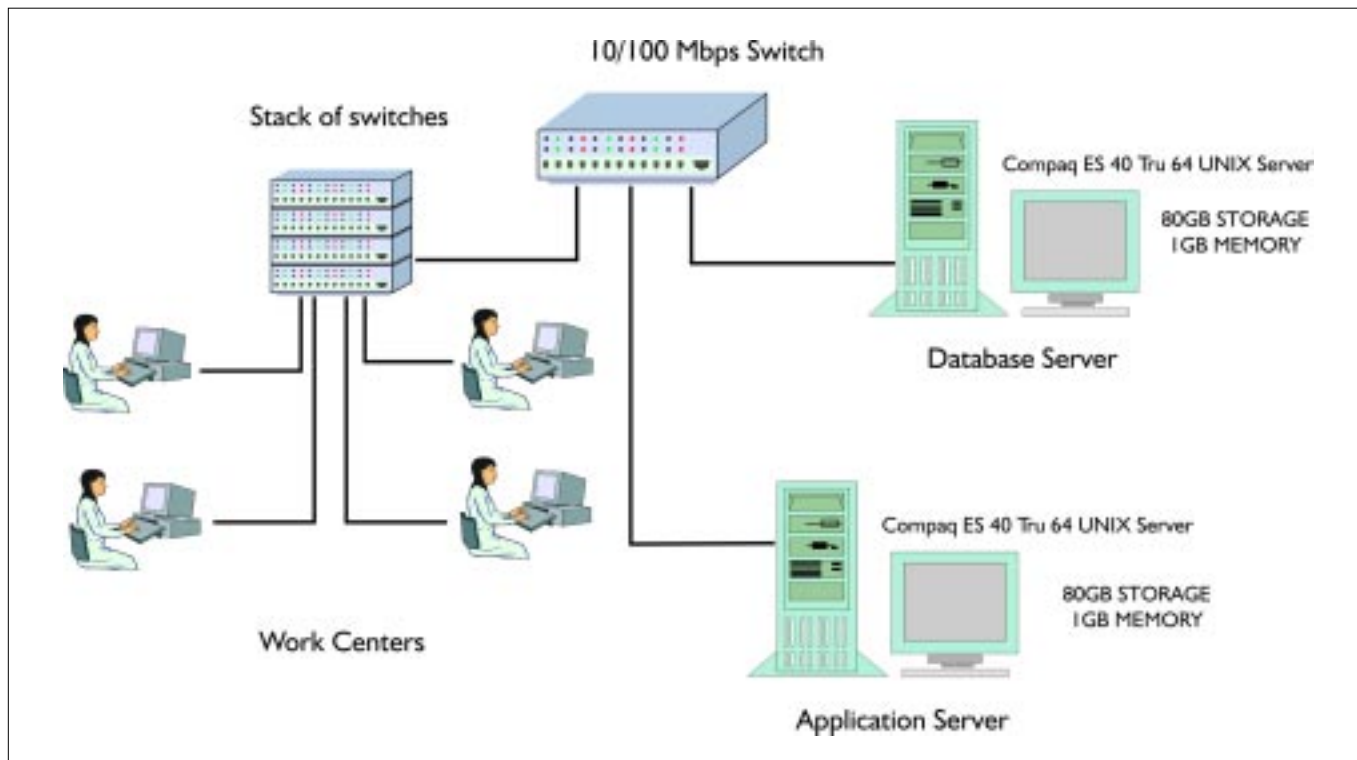

Figure 3.9.1 IIMS configuration

The various work centers involved in the production chain are :

- NRSA Data Center
- Data Processing Systems
- Special Products Generation System
- Filming System
- Photo Processing Facility
- Photolab
- Quality Control
- DQE System
- ADIF Regeneration System
- Archives

The work centers involved in the production chain for different products are different. The data product generation involves several complex sequence of operations and data product flow is based on the satellite, sensor, product type, level of correction, format and media. All this is achieved through the efficient computerised IIMS.

Various queries regarding data availability, quality of the data available and area coverage for the user specified requests are handled by NDC, using the utilities provided by IIMS.

4.1 ORBIT AND COVERAGE

The primary objective is to provide systematic and repetitive acquisition of data of the earth's surface under nearly constant illumination conditions. The orbit is same as that of IRS-1C i.e., the satellite operates in a circular, sun-synchronous, near polar orbit with an inclination of 98.69 deg, at an altitude of 817Km. The satellite takes 101.35 minutes to complete one revolution around the earth and completes about 14 orbits per day. The entire earth is covered by 341 orbits during a 24 day cycle. The orbital parameters are summarized in Table 4.1.1.

Orbits/cycle	341
Repeat cycle	24 days
Altitude	817 Km
Semi-major axis	7195.11 Km
Inclination	98.69 deg
Eccentricity	0.001
Period	101.35 min
Distance between adjacent traces	117.5 Km
Distance between successive ground tracks	2820 Km
Ground track velocity	6.65 Km/sec

Table 4.1.1 IRS-P6 Orbit

Table 4.1.1 IRS-P6 orbit

The mean equatorial crossing time at descending node is 10:30 a.m. \pm 5 minutes. The orbit adjust system is used to attain the required orbit initially and it is maintained throughout the mission period. The ground trace pattern is controlled within \pm 1 Km of the reference ground trace pattern. The sensors collect data with different swaths. The swath of LISS-III sensor, similar to that of IRS-1C, in the visible bands is 141 Km. Unlike IRS-1C, the swath of SWIR band is also 141 Km. The LISS-IV camera is operated in two modes Mono and Multi-spectral (MX). The Mono mode is similar to that of PAN of IRS-1C with 70 Km swath in any one of the spectral bands. In the MX mode, 4000 pixels of each spectral band are transmitted to provide 23 Km swath. The swath of AWIFS is 737 Km with the improved resolution compared to WiFS of IRS-1C.

Details of overlap and sidelap between scenes of a sensor are given in Table 4.1.2. The successive orbits are shifted westward by 2820 Km at the equator. Figure 4.1.1 shows a typical ground trace of the orbits. The entire globe is covered in 341 orbits between 81 deg North and 81 deg South latitudes, during the 24 day cycle.

Payload	Resolution (m)	Swath (Km)	Ground Image size(Km x Km)	Overlap (Km)	Sidelap (Km)
LISS-3					
Visible	23.5	141	142 x 141	7	23.5
SWIR	23.5	141	142 x 141	7	23.5
LISS-4					
Mono	5.8	70	70 x 70	2.5	5 (within LISS-3 scene)
MX	5.8	23	23 x 23	14.2	---
AWIFS	56 (nadir) 70 (end pixel)	737	738 x 737	82%	84%

Table 4.1.2 Overlap and sidelap between the scenes

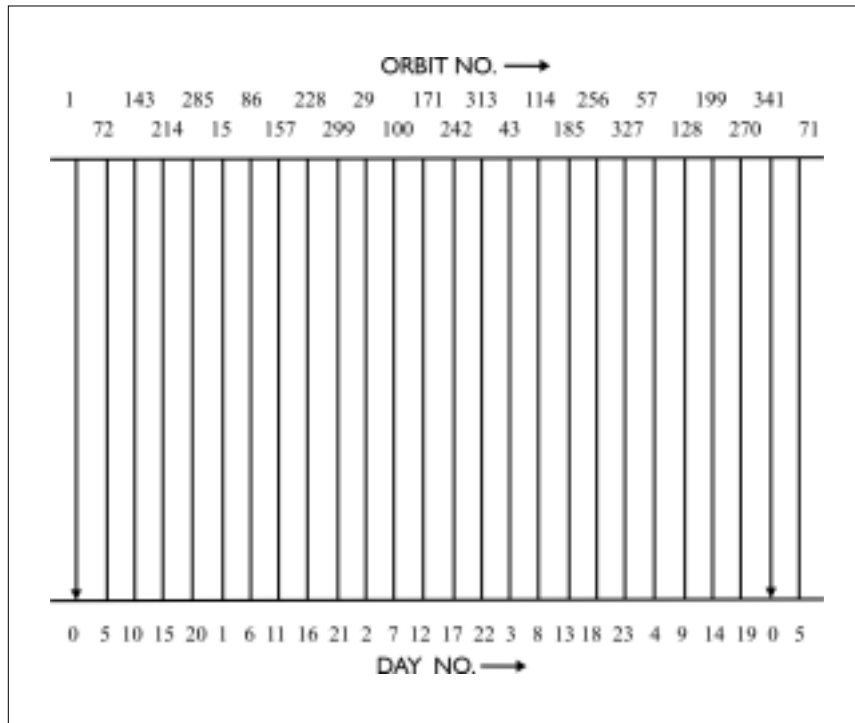

Figure 4.1.1 Ground trace pattern

Scene layout

Figure 4.1.2 shows the scene layout of LISS-III and LISS-IV mono scenes within a AWiFS scene. The corners are numbered for AWiFS scene as shown in the figure. The same pattern of marking the corners is followed for other payload scenes also. There is an overlap of 7 Km between adjacent scenes of LISS-III along a path and a sidelap of 23.5 Km between scenes of adjacent paths at equator. The sidelap is minimum at equator. As we go away from the equator, the sidelap increases, because the paths come closer to each other as we move towards the pole. Typically, at 40 deg latitude the sidelap is around 40% of the swath and at 81 deg latitude, it is 99%. As the swath of AWiFS is very large, there is a sidelap of about 84% between AWiFS scenes of adjacent paths at equator. But, between n^{th} and $n+5^{th}$ path which occur on consecutive days, the sidelap is around 149 Km at equator. Thus global coverage by AWiFS is still achieved in 5 days even with a reduced swath of

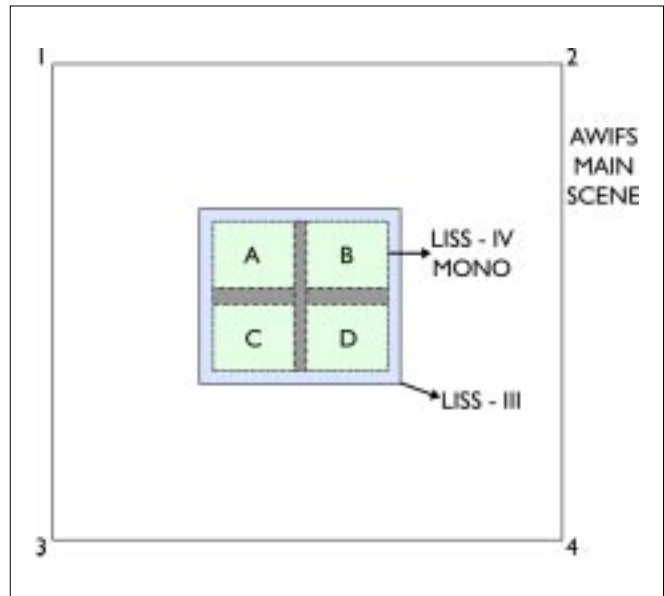

Figure 4.1.2 Scene layout of LISS-IV and LISS-III in AWiFS main scene

737 Km from the 810 Km of WiFS of IRS-1C. There is an overlap of around 82% between adjacent scenes in a path. But the overlap between the m^{th} and $m+5^{\text{th}}$ scenes along a path is around 62 Km. Hence one out of every consecutive five scenes can be downloaded for data products generation. Four subscenes are defined in each AWiFS main scene. More details about the referencing scheme is discussed in section 4.2.

Revisit capability of LISS-IV

Because of the tilting capacity of LISS-IV, a given area can be viewed more than once within a cycle. This is known as revisit due to tilting of LISS-IV. Figure 4.1.3 shows a path with three adjacent paths on either side from equator, the tilt angle with which

the central path can be viewed from adjacent paths and also the day number on which the adjacent paths occur relative to the central path. From the figure, it can also be seen that the maximum wait period to view an area is 5 days only. The maximum tilt angle being ± 26 deg, LISS-IV camera can see only three paths on either side at equator. As we go away from equator, paths become closer to each other. Hence, more number of paths can be viewed by LISS-IV at high latitudes.

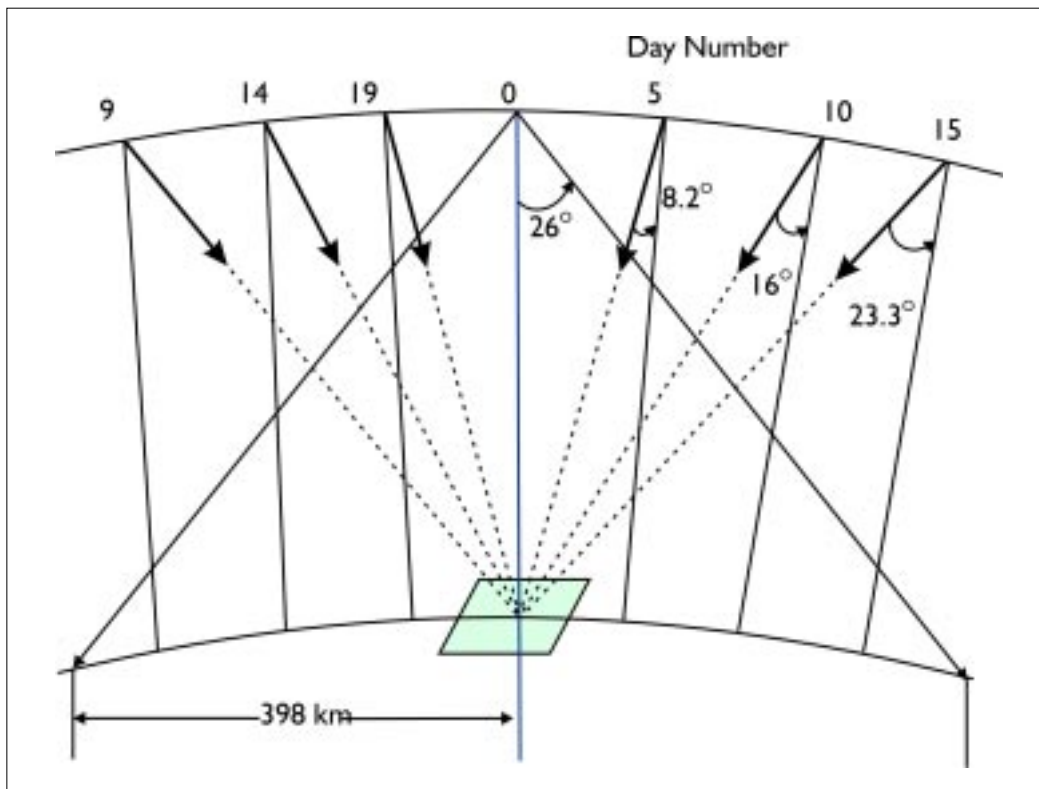

Figure 4.1.3 Coverage due to LISS-IV off-nadir capability

4.2 REFERENCING SCHEME

4.2.1. Introduction

Referencing scheme, which is unique for each satellite mission, is a means of conveniently identifying the geographic location of points on the earth. This scheme is designated by Paths and Rows. The Path-Row concept is based on the nominal orbital characteristics. This section describes the referencing scheme and related information.

4.2.1.1 New features of IRS-P6 relevant for referencing scheme and data products, with respect to IRS-1C

Though the payloads of IRS-P6 are similar to that of IRS-1C, there are improvements with respect to IRS-1C.

- * The resolution of SWIR band of LISS-IV is 23.5 m (same as that of other bands) in case of IRS-P6, whereas it is 70 m in case of IRS-1C.
- * AWIFS is designed with a better resolution (56 m at nadir and 70 m at edge) compared to that of WiFS (188 m) of IRS-1C.
- * The high resolution multi spectral camera LISS-IV works in two modes viz., Mono mode providing 70 Km swath in any one of the spectral bands and Multi-spectral mode providing 23 Km swath in all the three spectral bands. The swath of 23 Km could be selected anywhere within the 70 Km, by electronic switching facility.
- * Apart from the S-band based orbit determination, the position of the spacecraft is determined accurately using GPS measurement data obtained from the Satellite Positioning System onboard the satellite.
- * The pointing accuracy is 0.05 deg and the attitude determination accuracy using star sensor would be 0.014 deg in each of the axes.

4.2.2 Path

An orbit is the course of motion taken by the satellite, in space and the *descending* ground trace of the orbit is called a 'Path'. The orbit being similar to IRS-1C, the satellite completes 341 orbits in 24 days with an orbital period of 101.35 minutes. This way, the satellite completes approximately 14 orbits per day. Though the number of orbits and paths are the same, the designated path number in the referencing scheme and the orbit number are not the same. On day one (D1), the satellite covers orbit numbers 1 to 14, which as per the referencing scheme will be path numbers 1, 318, 294, 270, 246, 222, 198, 174, 150, 126, 102, 78, 54 and 30 assuming that the cycle starts with path 1. So orbit 1 corresponds to path 1, orbit 2 to path 318, orbit 3 to path 294 etc., The fifteenth orbit or first orbit of day two (D2), is path 6 which will be to the east of path 1 and is separated from path 1 by 5 paths. The path pattern is the same as that of IRS-1C. Path number one is assigned to the track which is at 29.7 deg West longitude. The gap between successive paths is 1.055 deg. All subsequent orbits fall westward. Path 1 is so chosen, that the pass with a maximum elevation greater than 86 deg for the data reception station of NRSA at Shadnagar can be avoided. This is due to the limitation of antenna drive speed, since, it is difficult to track the satellite around zenith. In fact, above 86 deg elevation, if a pass occurs, the data may be lost for a few seconds around zenith. Hence, the path pattern is chosen such that the overhead passes over the data reception station is reduced to a minimum. To achieve this, path 1 is positioned in such a manner that the data reception station is exactly between two nominal paths, namely 99 and 100. During operation, the actual path may vary from the nominal path pattern due to variations in the orbit by perturbations. Therefore, the orbit is adjusted periodically, after a certain amount of drift, to bring the satellite into the specified orbit. The path pattern is controlled within ± 1 Km about the nominal path pattern.

4.2.3 Row

Along a path, the continuous stream of data is segmented into a number of scenes of convenient size. As in case of IRS-1C, LISS-III is the primary payload and the scene centres of LISS-III are considered for defining rows. In case of IRS-P6, the scene centres of LISS-III are fixed to be same as that of IRS-1C as the orbit is same and the primary payload, LISS-III, is very much similar to that of IRS-1C. With respect to each scene centre, a LISS-III scene consisting of 6420 lines is framed so that the selected scene centre is the centre of the scene. The uniformly separated scene centres are, such that, same rows of different paths fall at the same latitude. The lines joining the corresponding scene centres of different paths are parallel to the equator and are called Rows. The row number 1 falls around 81 deg North latitude, row number 41 will be near 40 deg North and row number of the scene lying on the equator is 75. The Indian region is covered by row numbers 30 to 90 and path numbers 65 to 130.

4.2.4 Scene definition

The camera scans the ground track line by line continuously. The satellite motion along the track provides continuous imaging of the ground. This continuous stream of data is segmented to convenient sizes. These segments are called scenes. The camera system takes certain amount of time to read and register the CCD array data. This integration time is chosen prior to launch and is fixed throughout the mission. The integration time for each camera is so chosen, that, it is equivalent to the time taken by the satellite in nominal orbit to traverse the scan line distance of the respective cameras. The across track width is limited by the swath of the respective cameras. Due to the line-by-line mode of scanning, the along track scan is a continuous strip and is divided into a number of uniform scenes. Each line of the camera consists of a fixed number of CCD elements in the form of an array. The image obtained by one CCD element is a pixel. The pixel size on ground is

equal to the resolution of the respective cameras. The across track length of the scan (swath) is determined by the pixel size and number of elements in a line. Each imaging sensor scans line by line during its integration time, which is fixed for each camera. Thus, each camera scans a fixed number of lines in fixed intervals of time. Therefore, the along track length of a scene is based on the number of lines used to constitute that scene.

4.2.5 Use of referencing scheme

The Path-Row referencing scheme eliminates the usage of latitude and longitudes and facilitates convenient and unique identification of a geographic location. It is useful in preparing accession and product catalogues and reduces the complexity of data products generation. Using the referencing scheme, the user can arrive at the number of scenes that covers his area of interest.

However, due to orbit and attitude variations during operation, the actual scene may be displaced slightly from the nominal scene defined in the referencing scheme. Hence, if the user's area of interest lies in the border region of any scene, the user may have to order the overlapping scenes in addition to the nominal scene.

4.2.6 Comparison between IRS-P6 and IRS-1C referencing scheme

The referencing scheme of IRS-P6 is almost similar to that of IRS-1C as the orbit is same and the payloads are similar. As discussed in section 2.4, the referencing scheme of IRS-P6 is adopted from IRS-1C itself.

The size of LISS-III scene is same as that of IRS-1C. i.e. 142 Km x 141 Km. But the number of lines constituting the scene is slightly more compared to IRS-1C as the line integration time is different. Unlike IRS-1C where SWIR band has a size of 142 Km x 148 Km, it is same as other bands of

LISS-III in IRS-P6. Also the resolution of SWIR band is improved to 23.5 m from 70 m of IRS-1C.

The resolution of AWIFS is better compared to WIFS of IRS-1C. The scene centre of AWIFS is same as LISS-III scene centre as in case of IRS-1C. But the size of AWIFS scene is 738 Km x 737 Km which is slightly less compared to WIFS whose size is 810 Km x 810 Km. Also in addition to the AWIFS main scene of 738 Km x 737 Km, four sub-scenes within the AWIFS main scene, each of size 374 Km x 372 Km are defined corresponding to the two CCD arrays.

There are four LISS-IV mono scenes A, B, C and D within one LISS-III scene, like PAN scenes of IRS-1C. But the overlap between the A / C scenes and B / D scenes is increased to 5 Km as compared to 1 Km of IRS-1C. The overlap between A (or B) and C (or D) is increased to 2.5 Km as compared to 1 Km of IRS-1C.

4.2.7 LISS-III referencing scheme and scene coverage

The swath of LISS-III is 141 Km in all the four bands. Since the swath of LISS-III in all the four bands is greater than the inter orbit distance (117.5 Km), the sensor scans the entire globe once in every cycle without gaps. The referencing scheme of LISS-III consists of 341 paths numbered from west to east. Each path consists of 149 rows. Consecutive paths are covered with a separation of five days. If Path 1 is covered on day one, Path 2 will be covered on day six (Figure 4.2.1).

Each LISS-III scene covers an area of 142 Km x 141 Km. The side lap between two LISS-III scenes is 23.5 Km at the equator. The overlap between successive scenes in a path is 7 Km. (Figure 4.2.2)

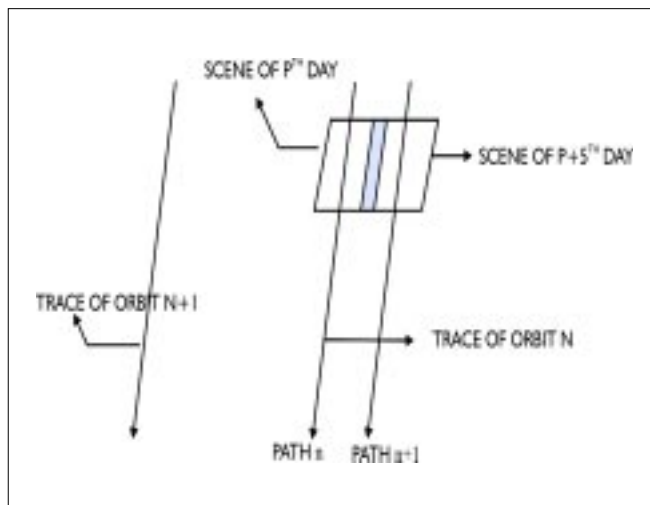

Figure 4.2.1 LISS-III coverage pattern.

4.2.8 LISS-IV referencing scheme and scene coverage

4.2.8.1 Mono Mode

As already mentioned in section 2.4, LISS-IV camera consists of three CCD arrays having 12000 elements in each of the three spectral bands. The camera operates in two modes *Mono* and *Multi-spectral*. In Mono mode, the data corresponding to 12000 pixels of one of the CCD arrays is downlinked. So, Mono mode provides a swath of 70 Km in one of the spectral bands. *Mono* scenes from nadir view lead to gaps between the scenes as the path to path separation is 117.5 Km at the equator and the swath is only 70 Km. Therefore, as in the case of IRS-1C four mono scenes A, B, C and D are defined in one LISS-III scene. The mono scenes are referred to by the same path number and row number as that of LISS-III along with the suffixes A, B, C and D. The A/C strip is acquired with approximately -2 deg tilt and B/D strip is acquired with approximately 2 deg tilt. So by tilting the camera, entire globe can be covered, in two cycles. Figure 4.2.3 provides the layout of LISS-IV mono scenes in LISS-III scene. The overlap between A and C (or B and D) is 2.5 Km within a

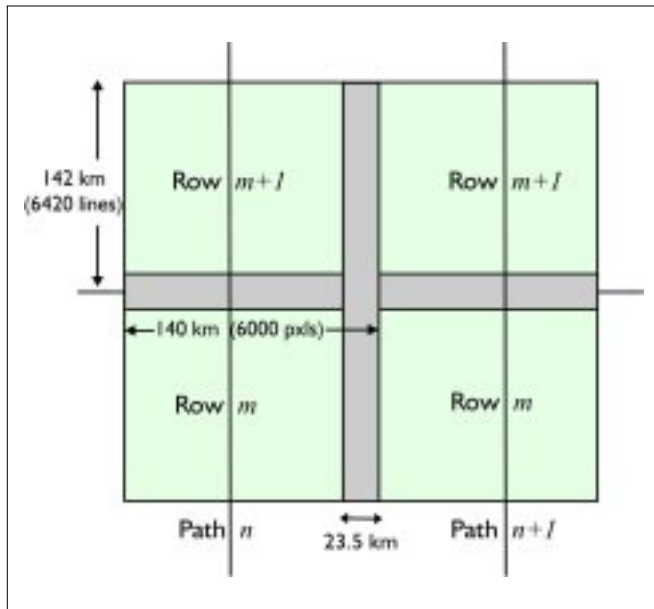

Figure 4.2.2 LISS-III scene layout

As the acquired MX strips could be anywhere longitudinally because of the tilt and electronic switching facility, there is no path based scheme for MX mode. Hence, the user has to specify his area of interest in terms of latitude and longitude

4.2.9 AWIFS referencing scheme and scene coverage

The AWIFS referencing scheme is also based on LISS-III scene centre. However, due to the large coverage of each AWIFS scene (738 Km x 737 Km), there is an overlap of 84% between adjacent paths at equator. Similarly, the overlap between adjacent rows is 82%. So, if a user requires continuous area, say, 1200 Km x 1200 Km, it is enough if he orders for four AWIFS scenes. The point to be noted here, is that, the user should order data pertaining to path P and path P+5 (which is covered on the next day) and rows m and m + 5 of paths P and P+ 5 to cover his entire area. This way user gets data pertaining to his area within two days (Figure 4.2.4). The huge

LISS-III scene and the overlap between C and A (or D and B) The side lap between A /C and B/D is increased to 5 Km from 1 Km of IRS-1C to ensure overlap taking into account ground track shift and attitude errors. It is to be noted that this layout for LISS-IV is chosen for referencing scheme only. Otherwise due to tilting up to ±26 deg, the scenes can be anywhere within ±400 Km from nadir in the cross-track direction.

4.2.8.2 Multi-spectral (MX) Mode

In MX mode, data corresponding to 4000 pixels of each spectral band is transmitted. Due to the electronic switching facility, this set of 4000 pixels could be selected anywhere within 12000 pixels i.e. the start pixel could be any value from 1 to 8001. This gives the advantage of selecting 23 Km swath (corresponding to 4000 pixels) anywhere within the chosen 70 Km due to tilt. Because of the electronic switching facility, many MX requests could be serviced with a single tilt.

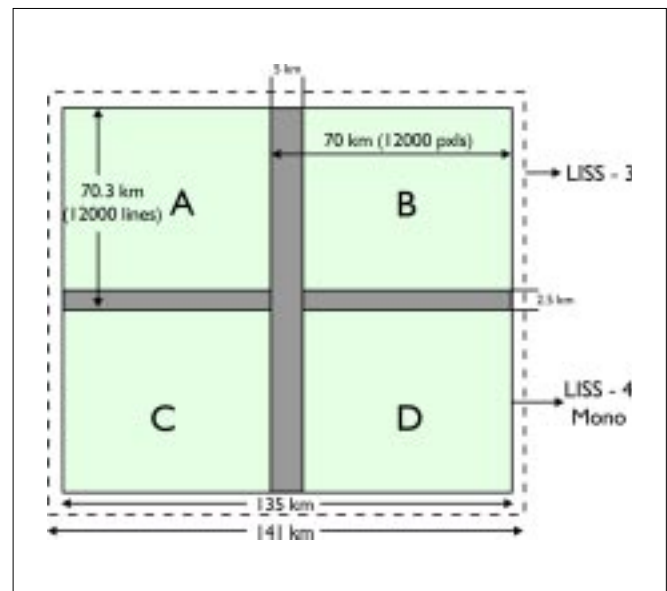

Figure 4.2.3 LISS-IV scenes (Mono) within a LISS-III scene

overlaps between the AWiFS scenes of adjacent paths results in repeated coverage of the same area in a given cycle. A given scene can be covered completely on its day of pass and also by a combination of two scenes acquired on different days during the cycle. Take again path P1 which is covered on day D1. The area pertaining to Path P1 can also be covered by the following combinations of paths acquired on various days during the cycle. This is the case at the equator. Since at higher latitudes the overlap is more, the coverage becomes more frequent.

P3 -P340	11 th and 15 th
P3 -P341	11 th and 20 th
P4 -P339	16 th and 10 th
P4 -P340	16 th and 15 th
P4 -P341	16 th and 20 th

Combination of Day of the cycle paths

P2 -P337	6 th and 24 th
P2 -P338	6 th and 5 th
P2 -P339	6 th and 10 th
P2 -P340	6 th and 15 th
P2 -P341	6 th and 20 th
P3 -P338	1 st and 5 th
P3 -P339	11 th and 10 th

In addition to the AWiFS main scene of 738 Km X 737 Km, four sub-scenes A, B, C and D are defined within AWiFS main scene corresponding to the two CCD arrays of 6000 elements each. Each sub-scene is of size 374 Km x 372 Km. The sub-scene layout is similar to that of LISS-IV mono scenes within a LISS-III scene. There is a sidelap of 8.4 Km (150 pixels) between A/C and B/D scenes and there is an overlap of 10 Km (150 lines) between A (or B) and C (or D) (Figure. 4.2.5).

4.2.10 Indian and World referencing scheme maps

The following referencing scheme maps are available for users reference:

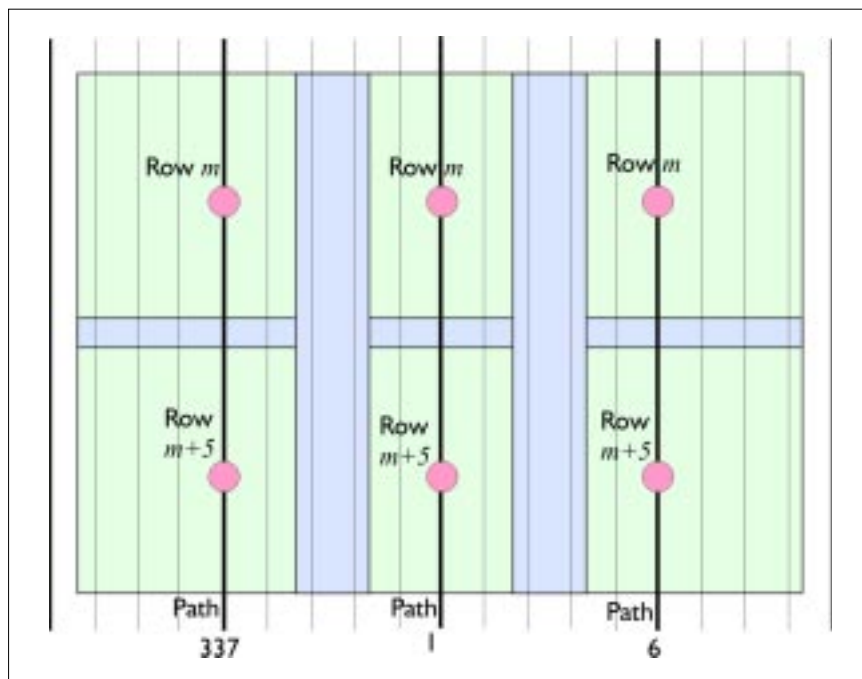

Figure 4.2.4 AWiFS scene coverage

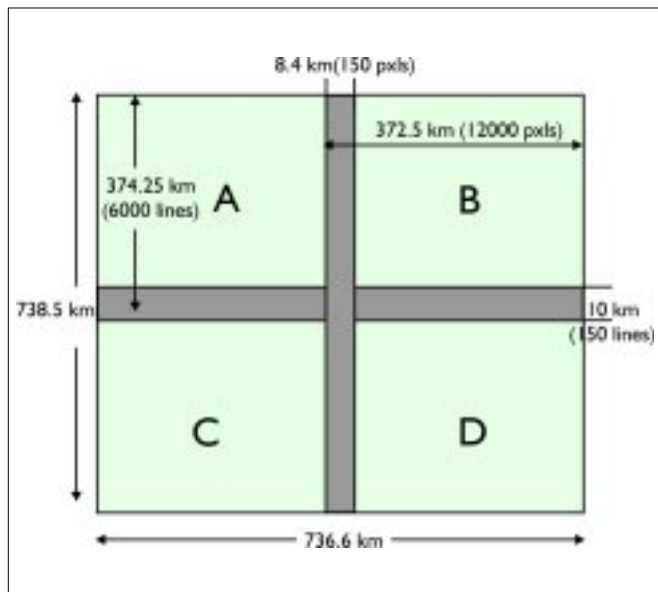

Figure 4.2.5 Sub-scenes of AWiFS within main scene

- i) India and neighboring countries on 1: 6,000,000 scale
- ii) Six zones of India, namely, Central, North, South, East, West and Andaman Nicobar, on 1 : 4,500,000 scale
- iii) The entire coverage of Hyderabad earth station on 1: 12,800,000 scale

A world referencing scheme map has been produced for ready reference of path and row numbers over the total coverage of IRS on land and water from 81°N to 81°S. The map is in mercator projection. The scale of this map is 1: 62 million.

The referencing scheme map of following world zones are also available on larger scales: Asia, Europe, North America, Africa, Australia and Antarctica.

4.2.11 Determination of observation dates

For the chosen path, the ground track repeats every 24 days after 341 orbits. Therefore, the coverage

pattern is almost constant. The deviations of orbit and attitude parameters are controlled within limits such that the coverage pattern remains almost constant through out the mission. Therefore, on any given day, it is possible to determine the orbit which will trace a designated path. Once the path is known, with the help of referencing scheme, it is possible to find out the region covered by that path. Therefore, an orbital calendar, giving the details of paths, covered on different days is helpful to users to plan their procurement of satellite data products.

Considering a typical path calendar (Table 4.2.1), assuming that path number 1 is covered on January 11, if data over a geographic area covered by path 60 is required, it is seen that this path is covered on days, 18th of January, 11th of February, 06th of March and so on. Thus, it is possible to know on which day the required data has been collected or is going to be collected.

4.2.12 Estimation of path and row, local clock time and other details for any point on the Indian sub-continent

The procedure outlined below may be used to determine the path and row, Greenwich Meridian Time (GMT) and the local clock time when the satellite passes over any point in the Indian sub-continent.

- i. Define the latitude and longitude of the point of interest over Indian region.
- ii. Determine the approximate descending node as follows:
 1. Locate the latitude of the point of interest in Table 4.2.2. Table 4.2.2 gives the longitudinal difference from the given longitude to the descending node longitude as a function of latitude.
 2. Read the value of longitude from this table. If the latitude falls within two values, then, interpolate and get required longitude.

Path	167	172	177	182	187	168	173	178	183	188	169	174	179	184	189	170	175	180	185	190	171	176	181	186
	143	148	153	158	163	144	149	154	159	164	145	150	155	160	165	146	151	156	161	166	147	152	157	162
	119	124	129	134	139	120	125	130	135	140	121	126	131	136	141	122	127	132	137	142	123	128	133	138
	95	100	105	110	115	96	101	106	111	116	97	102	107	112	117	98	103	108	113	118	99	104	109	114
	71	76	81	86	91	72	77	82	87	92	73	78	83	88	93	74	79	84	89	94	75	80	85	90
	47	52	57	62	67	48	53	58	63	68	49	54	59	64	69	50	55	60	65	70	51	56	61	66
	23	28	33	38	43	24	29	34	39	44	25	30	35	40	45	26	31	36	41	46	27	32	37	42
	340	4	9	14	19	341	5	10	15	20	1	6	11	16	21	2	7	12	17	22	3	8	13	18
	316	321	326	331	336	317	322	327	332	337	318	323	328	333	338	319	324	329	334	339	320	325	330	335
	292	297	302	307	312	293	298	303	308	313	294	299	304	309	314	295	300	305	310	315	296	301	306	311
	268	273	278	283	288	269	274	279	284	289	270	275	280	285	290	271	276	281	286	291	272	277	282	287
	244	249	254	259	264	245	250	255	260	265	246	251	256	261	266	247	252	257	262	267	248	253	258	263
	220	225	230	235	240	221	226	231	236	241	222	227	232	237	242	223	228	233	238	243	224	229	234	239
	196	201	206	211	216	197	202	207	212	217	198	203	208	213	218	199	204	209	214	219	200	205	210	215
				192					193					194					195					191

Month	1	2	3	4	5	6	7	8	9	10	11	12	13	14	15	16	17	18	19	20	21	22	23	24
Jan	25	26	27	28	29	30	31																	
Feb	18	19	20	21	22	23	24	25	26	27	28	29												
Mar	13	14	15	16	17	18	19	20	21	22	23	24	25	26	27	28	29	30	31					
Apr	6	7	8	9	10	11	12	13	14	15	16	17	18	19	20	21	22	23	24	25	26	27	28	29
May	24	25	26	27	28	29	30	31																
Jun	17	18	19	20	21	22	23	24	25	26	27	28	29	30										
Jul	11	12	13	14	15	16	17	18	19	20	21	22	23	24	25	26	27	28	29	30	31			
Aug	4	5	6	7	8	9	10	11	12	13	14	15	16	17	18	19	20	21	22	23	24	25	26	27
Sep	21	22	23	24	25	26	27	28	29	30														
Oct	15	16	17	18	19	20	21	22	23	24	25	26	27	28	29	30	31							
Nov	8	9	10	11	12	13	14	15	16	17	18	19	20	21	22	23	24	25	26	27	28	29	30	
Dec	2	3	4	5	6	7	8	9	10	11	12	13	14	15	16	17	18	19	20	21	22	23	24	25

Table 4.2.1 Typical Orbital Calendar of IRS-P6

3. Add this value to the longitude of the point of interest, to get rough estimate of descending node longitude.
- iii. The actual descending node details are obtained as follows:
 1. Table 4.2.3 gives the descending node longitude of all paths over the Indian region. Find the path nearest to the longitude computed in step ii. This gives the path number and descending node longitude of the path.
 2. Table 4.2.4 gives the descending node time (GMT) expected for each path over the Indian sub-continent.
- iv. GMT at the point of interest is found as follows:
 1. Given a latitude, using the nominal inclination of the orbit, the time of descending node can be calculated
 2. Add the time to the GMT of the descending node as obtained in step iii, by carefully noting the algebraic sign.
- v. The Indian Standard Time (IST) is obtained by adding five and a half hours to the time (GMT) obtained in step iv.
- vi. Table 4.2.2 gives the row numbers versus latitude. Find the nearest row latitude from this table and assign the same row number. Thus, with the above procedure, the path and row numbers and other details of the point of interest can be obtained.

4.2.13 Framing procedure and scene centre corner co-ordinates evaluation for the referencing scheme

Based on the reference orbit, ephemeris are generated for all the 341 orbits of a coverage cycle. From the ephemeris, all the details about the paths over the Indian sub-continent are extracted. These details are path number, descending node details etc.,. Descending nodal points of all the paths are scene

centres. All the details of LISS-III scenes along the paths are obtained taking descending nodal points as reference. While assigning the row numbers, counting is done from northern most scene centre on a path. The size of LISS-III scene is 6000 pixels X 6420 lines. The scene centre latitudes are obtained from the nominal referencing scheme and the corresponding time is computed based on ephemeris. Once scene centre time is known, by taking 3210 lines above and below that point the scene start and end timings can be obtained. In this process, the along track overlap is automatically taken care of and the sidelap is given by ground track placements. Similarly, all the LISS-III scenes are sized along the track. By evaluating corner coordinates of each scene, the framing is completed. The details about corner co-ordinates computation is provided in the next section. Scene framing for payloads AWiFS and LISS-IV is done in a similar manner

4.2.14 Estimation of the centre and corner co-ordinates of LISS-III and LISS-IV scenes

From the ephemeris information, it is possible to compute geographical co-ordinates of LISS-III scene centres which lie on the ground track. However, this is not the case with LISS-IV scene centers as they lie on either side of the ground track. The time of occurrence of any LISS-IV scene center or any corner co-ordinate is obtained by using the information that the scanning is line by line at an interval of integration time of the respective cameras. Taking LISS-III scene center as the origin, the coordinates of any point is established in terms of lines and pixels.

In Figure 4.2.6, let a1 be a point on the ground track with coordinates (ϕ_1, λ_1) . Let P be a corner point of a scene. The coordinates of P say (ϕ_2, λ_2) , can be calculated as follows.

$$\sin \phi_2 = \cos \theta \sin \phi_1 \pm \sin \theta \cos \phi_1 \cos \alpha \dots\dots\dots(1)$$



Latitude	Row No.	Longitude	Latitude	Row No.	Longitude
81.30	1	-88.78	42.79	39	-11.12
81.06	2	-81.05	41.61	40	-10.70
80.68	3	-73.82	40.43	41	-10.30
80.18	4	-67.23	39.25	42	-9.91
79.56	5	-61.34	38.07	43	-9.53
78.84	6	-56.15	36.89	44	-9.16
78.05	7	-51.58	35.71	45	-8.80
77.20	8	-47.59	34.53	46	-8.44
76.30	9	-44.08	33.34	47	-8.10
75.36	10	-41.00	32.16	48	-7.76
74.38	11	-38.29	30.97	49	-7.42
73.37	12	-35.87	29.79	50	-7.10
72.35	13	-33.72	28.60	51	-6.77
71.30	14	-31.79	27.41	52	-6.46
70.23	15	-30.05	26.22	53	-6.15
69.16	16	-28.48	25.04	54	-5.84
68.07	17	-27.04	23.85	55	-5.54
66.97	18	-25.73	22.66	56	-5.24
65.86	19	-24.53	21.47	57	-4.94
64.74	20	-23.41	20.28	58	-4.65
63.62	21	-22.38	19.09	59	-4.36
62.49	22	-21.42	17.89	60	-4.08
61.36	23	-20.53	16.70	61	-3.79
60.22	24	-19.69	15.51	62	-3.51
59.07	25	-18.90	14.32	63	-3.23
57.93	26	-18.16	13.13	64	-2.96
56.78	27	-17.45	11.93	65	-2.68
55.62	28	-16.79	10.74	66	-2.41
54.47	29	-16.16	9.55	67	-2.14
53.31	30	-15.55	8.35	68	-1.87
52.15	31	-14.98	7.16	69	-1.60
50.98	32	-14.43	5.97	70	-1.33
49.82	33	-13.90	4.77	71	-1.06
48.65	34	-13.39	3.58	72	-0.80
47.48	35	-12.91	2.39	73	-0.53
46.31	36	-12.43	1.19	74	-0.27
45.13	37	-11.98	0.0	75	0.00
43.96	38	-11.54			

Table 4.2.2 The difference in longitude of a given row latitude and descending time

Path	Longitude	Path	Longitude
65	37.866	101	75.72
66	38.922	102	76.928
67	39.977	103	77.983
68	41.033	104	79.039
69	42.089	105	80.095
70	43.145	106	81.150
71	44.200	107	82.206
72	45.256	108	83.262
73	46.312	109	84.318
74	47.367	110	85.373
75	48.423	111	86.429
76	49.479	112	87.485
77	50.535	113	88.540
78	51.590	114	89.596
79	52.646	115	90.652
80	53.702	116	91.708
81	54.757	117	92.763
82	55.813	118	93.819
83	56.869	119	94.875
84	57.925	120	95.930
85	58.980	121	96.986
86	60.036	122	98.042
87	61.092	123	99.098
88	62.148	124	100.153
89	63.203	125	101.209
90	64.259	126	102.265
91	65.315	127	103.321
92	66.370	128	104.376
93	67.426	129	105.432
94	68.482	130	106.488
95	69.538	131	107.543
96	70.593	132	108.599
97	71.649	133	109.655
98	72.705	134	110.711
99	73.760	135	111.766
100	74.816		

Table 4.2.3 Equatorial crossing longitude for paths over Indian region

Path	GMT	Path	GMT
65	7:59	101	5:27
66	7:54	102	5:22
67	7:50	103	5:18
68	7:46	104	5:14
69	7:42	105	5:10
70	7:37	106	5:05
71	7:33	107	5:01
72	7:29	108	4:57
73	7:25	109	4:53
74	7:21	110	4:49
75	7:16	111	4:44
76	7:12	112	4:40
77	7:08	113	4:36
78	7:04	114	4:32
79	6:59	115	4:27
80	6:55	116	4:23
81	6:51	117	4:19
82	6:47	118	4:15
83	6:43	119	4:11
84	6:38	120	4:06
85	6:34	121	4:02
86	6:30	122	3:58
87	6:26	123	3:54
88	6:21	124	3:49
89	6:17	125	3:45
90	6:13	126	3:41
91	6:09	127	3:37
92	6:05	128	3:32
93	6:00	129	3:28
94	5:56	130	3:24
95	5:52	131	3:20
96	5:48	132	3:16
97	5:43	133	3:11
98	5:39	134	3:07
99	5:35	135	3:03
100	5:31		

Table 4.2.4 Equatorial crossing time (GMT) for paths over Indian region (Local time at descending node 10:30 hrs)

where $\alpha = 2\pi - \zeta \pm \pi/2$ and θ, ϕ_1, ϕ_2 and ζ are the angles as shown in Figure 4.2.6

$$\begin{aligned} \cos \theta &= \sin \phi_1 \sin \phi_2 \pm \\ \cos \phi_1 \cos \phi_2 \cos \Delta & \dots\dots\dots(2) \end{aligned}$$

where Δ is longitudinal difference of λ_2 from λ_1 and θ is the angle subtended by arc aP (Fig. 4.2.6) at the centre of the Earth.

Using equation (2) the expression for 'Cos Δ ' can be derived as

$$\begin{aligned} \cos \Delta &= (\cos \theta - \sin \phi_1 \sin \phi_2) / \\ (\cos \phi_1 \cos \phi_2) & \dots\dots\dots(3) \end{aligned}$$

Appropriate sign is used to denote depending on whether the point P (ϕ_2, λ_2) is east or west of point a (ϕ_1, λ_1). The longitude λ_2 is therefore obtained as

$$\lambda_2 = \lambda_1 \pm \Delta$$

Thus, the geographical co-ordinates of any required point can be obtained either for any corner or the centre of the scene.

4.2.15 Deviations of orbit and attitude parameters and its effect on the image

The referencing scheme has been generated for the reference orbit under ideal conditions. In practice, orbital parameters vary from the reference orbit due to perturbations. Similarly, due to internal and external torques acting on the satellite, its attitude slowly drifts. Both orbit and attitude parameters are controlled within certain limits by the attitude and orbit control system. These perturbations cause the scenes to slightly deviate from the nominally predicted locations. It is therefore necessary for users to understand the deviations to see how best they can use the successive images of a specific scene, for registering, overlaying and for comparison. In this

section, a brief summary of the image deviations is given.

Orbit Perturbations

In order to maintain the required coverage pattern and local time, it is essential that the defined sun-synchronous orbit be maintained throughout the operational lifetime of the satellite. Even after the launch vehicle injection errors are removed, the perturbations to the orbit, orbit determination and orbit adjust system uncertainties cause deviations from the ideal sun-synchronous orbit. Hence, orbital parameters have to be controlled close to the ideal orbit within the tolerance specified. The main perturbations are due to atmospheric drag, asphericity of the Earth and to some extent by lunisolar gravitational attraction. Deviations caused by these are corrected by periodic orbit adjust operations. The effect of the deviations within the limits of these corrections are discussed in subsequent sections.

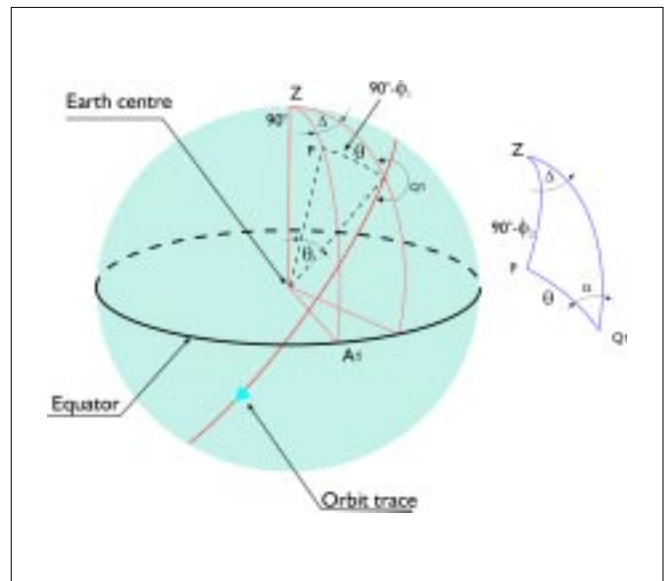

Figure 4.2.6 Calculations of coordinates of a point P on the earth surface.

Atmospheric Drag

Though the atmospheric density is small at an altitude of about 1000 Km, the same cannot be neglected, as it causes gradual loss of altitude continuously, if the same is not controlled. Due to altitude decay, the time period of the orbit changes which affects the ground track pattern and therefore coverage pattern. It is planned to control the ground track pattern to within ± 1 Km of the nominal pattern. This would be achieved by suitably controlling the altitude within corresponding limits. Periodicity of altitude corrections depends on the decay rate.

Asphericity of the Earth

Asphericity of the earth has two major effects, namely;

- i. Circular orbit becomes eccentric and eccentricity varies in a sinusoidal fashion.
- ii. Apisidal line, that is the line joining the perigee and apogee points in the orbit, rotates in the orbital plane. The period of this rotation for IRS orbit is estimated to be around 132 days. Due to the frozen orbit concept, to be adopted for IRS-P6, the perigee is almost maintained near the orbital pole and the mean eccentricity is maintained at 0.0010033.

Eccentricity leads to variations in altitude as well as velocity. Since the earth is geoid shaped, even for a pure circular orbit, satellite does not have same altitude throughout the orbit. The altitude variations cause scale variations of the image (Figure. 4.2.7) for a given camera system. Due to the frozen perigee, altitude variations over the Indian region would be within 10 Km.

Equator is taken as the reference for framing the scenes while generating the referencing scheme. Equator is also being taken as reference during the actual operations and the descending node point is

determined based on the current ephemeris. Hence, the alongtrack error due to eccentricity is negligible at this point. Taking this point as reference, the other LISS-III scene centres are marked on a given path at equal time intervals.

Luni-Solar Gravitational Attraction and Solar Radiation Pressure

Additional perturbations to the orbit are examined here. This includes luni-solar gravitational attraction and solar radiation pressure. For IRS, the solar radiation pressure has negligible effects, whereas, luni-solar gravitational attraction causes secular variations of about 0.041 degree per year in inclination, apart from periodic variations. Variations in the inclination affects ground track pattern as well as local time. Since the variations are secular, compensation can be done easily. The inclination is biased by 0.02 degree towards a favourable side, so that it drifts to the nominal value after 6 months. Yearly corrections to inclination will be done to restrict

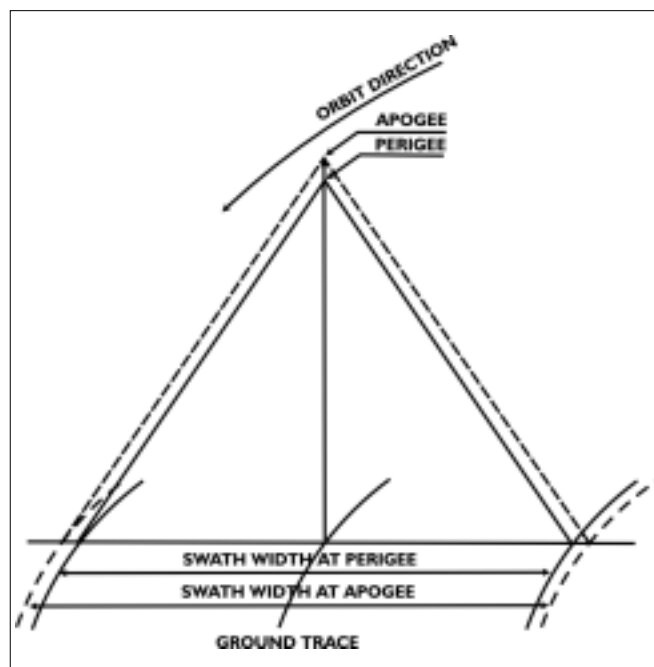

Figure. 4.2.7 Scale variations of image with altitude

its contribution to local time variation within ± 0.4 minutes, as shown in Figure.4.2.8.

4.2.16 Orbit determination and prediction errors

It is rather difficult to model accurately all the perturbing forces to represent the true motion of the satellite. When orbit predictions are carried out, the trajectory deviates from the true trajectory and the deviation builds up continuously. Therefore, periodic orbit determinations would be carried out using tracking observations of the satellite (like range, range rate etc.,). Since, both dynamic model and observations are imperfect and there are many observations than the number of parameters to be determined, this is an over determined system and therefore orbit determination would be carried out using an estimation technique in the statistical sense. The positional accuracy of the definitive orbit would be less than 100m (3 sigma) and after one day prediction, the positional accuracy will be around 150m (3 sigma).

In IRS-P6, the position of the spacecraft is also available by means of SPS (Satellite Positioning System). In SPS mode (directly which comes from onboard), the positional accuracy is around 100 m

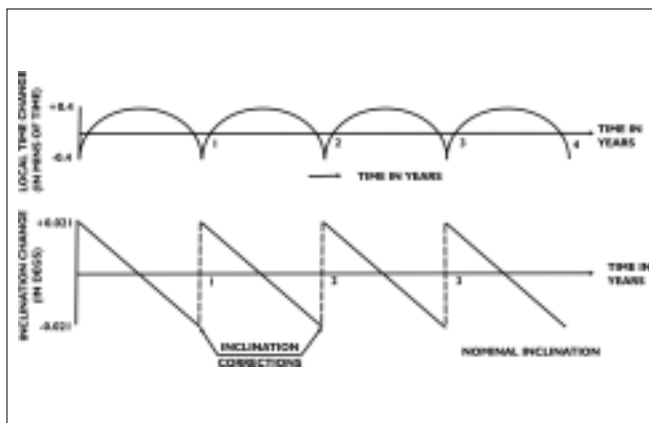

Figure. 4.2.8 Local time control by inclination correction

(2 sigma) and ground based estimation using SPS measurement data (GPS mode) provides an accuracy of around 10 m (1 sigma).

For browse and standard products, definitive orbital ephemeris are used. The image location accuracy in each of these products are affected by the accuracy cited above.

4.2.17 Deviation of attitude parameters

To align the payload cameras along the nadir line continuously, IRS has been configured for 3 axis stabilized mode of attitude which is achieved through a set of attitude sensors and control hardware. Controlling is necessary because of environmental and internal torques which affect the attitude stabilization continuously. Due to the presence of various errors in attitude sensing and controlling, the attitude would be controlled up to 0.05 degree in each of the yaw, roll and pitch axes with star sensor in control loop. The effect of pitch, roll and yaw on image is shown in Figure 4.2.9. The pitch error shifts the scene in the along track direction, whereas, roll error shifts the scene in the across track direction. Due to yaw error, the scene is rotated through the same angle about the nominal scene centre. The attitude determination accuracy is better than the controlling accuracy and would be ± 0.014 degree in each of the axes using star sensor. The deviations of scenes from the nominal depends only on the controlling accuracy. Determined attitude information is used to correct the image and for annotation.

Across track deviations of the image

Across track deviations of the image essentially depends on ground track pattern deviations, the accuracy of information on ground track, roll and yaw errors etc.,. Taking into account the uncertainties in orbit determination and orbit adjust system, the ground track pattern would be controlled within ± 1 Km. about the nominal pattern. It is clear that the

above implies a reduction in effective window to account for orbit determination and orbit adjust system uncertainties. Roll error of 0.05 degree causes track deviations of about 0.7 Km and yaw error of 0.05 degree would cause 0.09 Km under the worst case. The Root Sum Square (RSS) of all these deviations is about 1.2 Km.

Along track deviations of the image

The along track deviations of the image are due to eccentricity, orbit determination /prediction accuracy, the shape of the earth, and attitude control accuracy. The eccentricity effect is considered to some extent by choosing the frozen orbit concept. Velocity variations due to eccentricity are considered in the referencing scheme itself. Pitch error of 0.05 degree would cause 700 m along track deviation at the worst case. The component of yaw introduces 80 m error. One day predicted ephemeris are used for browse products which have positional information to the

accuracy of about 150 m. With all these, the along track deviation is about 720 m (RSS). This deviation is reduced by following an appropriate framing procedure during actual operations. However, the across track deviation within 1.2 Km cannot be reduced by any such procedures as it is a derivative of all the system components involved.

4.2.18 Image framing during actual operations

In the earlier section, the deviations of the actual scenes with respect to nominal scenes have been described. For mosaic generation, user may have to use scenes obtained in different coverage cycles. With such large deviations, it was found that mosaic formation may be difficult, and also the user may have to order several scenes, to get the required area information. During the process of evolution, it was found that it is difficult to reduce the across track deviations, whereas, with an appropriate procedure for image framing, there is a possibility of reducing

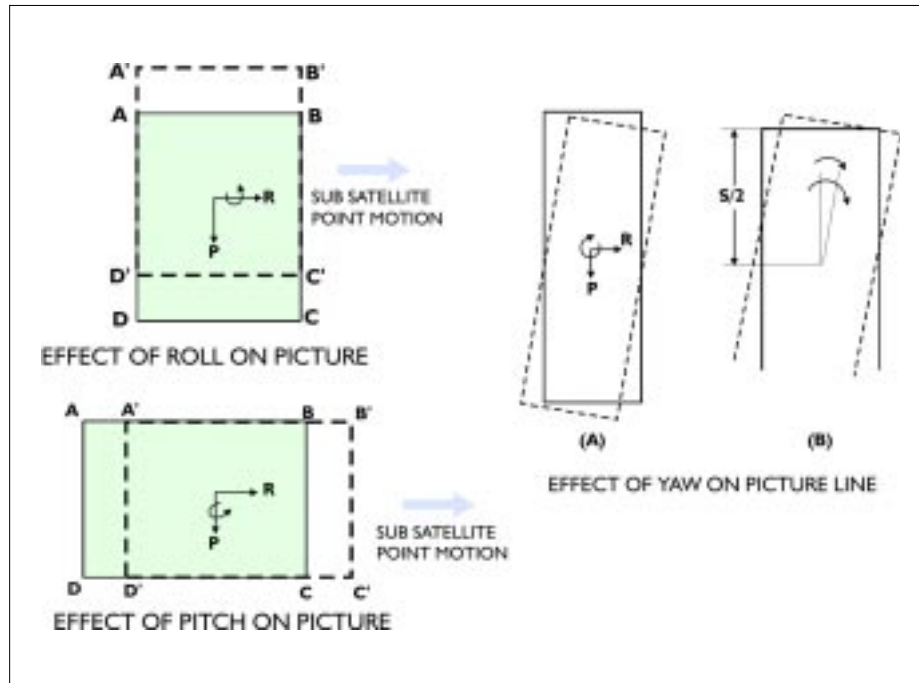

Figure. 4.2.9 Effect of attitude errors on image

the along track deviations. Therefore, it was decided to adopt this method during actual operations. It may be noted, that, image deviation means the distance between the centre of the actual scene obtained and the centre of the corresponding scene defined in the path-row referencing scheme. This should be distinguished from the location accuracy determined by the orbit and attitude information.

The following framing procedure is being adopted :

- i. All the relevant row latitudes as defined in the referencing scheme are stored.
- ii. The same row latitudes for actual scenes are adopted. This is accomplished by interpolating the time for a given row latitude along the path.
- iii. All the LISS-III scene centres along the path are marked by following the above procedure.
- iv. The LISS-III scenes about the above scene centres are constructed by taking 3120 lines above and below about these points along the path. The end and beginning of each LISS-III scene along the path are marked.
- v. AWIFS and LISS-IV scenes are then framed in and on LISS- 3 scenes, by adopting the same procedure.

The main advantage of the above procedure is, that, major portion of the along track deviation with respect to the nominal scenes get reduced. Thus, the final deviations are

Along track	:	± 720 m
Across track	:	± 1.2 Km

4.2.19 Impact of the deviations on overlap and sidelap during operational lifetime

While framing the images for the referencing scheme, adequate overlap (along track) and sidelap

(across track), are provided to aid the users to form a mosaic for a particular area or the complete Indian region. Within a coverage cycle of 24 days, the impact of deviations is negligible and if the quality of all the images are good, then, it is possible to create a mosaic. However, in actual practice, quality of all the images may not be good, due to the presence of cloud or some other reasons. Therefore, it is necessary to take images of different coverage cycles to generate the mosaic. In ideal situations, overlap or sidelap between adjacent images will exist. However, in actual practice, the deviation mentioned in the earlier sections will affect sidelap/overlap between images of one cycle and corresponding images of any other cycle during the operational lifetime of the satellite. For example, a scene of cycle N1 corresponding to path and row of P1 and R1 has a prescribed amount of overlap with a scene of the same cycle corresponding to path and row of P1, R1 + 1. However, it may not have the same amount of overlap, due to deviations, with a scene of cycle N2 corresponding to path and row of P1, R1 + 1. Similar is the situation for sidelap.

Overlap or sidelap variations occur due to the deviations mentioned in the earlier section and due to scale variation in the image because of variations in the altitude. However, scale variation affects only sidelap but not overlap as scanning is accomplished line by line, along the track.

Overlap Variation

The nominal overlap provided between any two LISS-III scenes is 7 Km. The maximum deviation (along the track) is of the order of 720 m, with the new framing procedure. Due to this, the distance between two scenes of different cycles will be slightly different.

Sidelap Variation

Sidelap is the common area between two adjacent

scenes of any two consecutive paths. However, sidelap between scenes of two consecutive paths of different cycles is affected by across track deviations and scale variations. The nominal sidelap increases from equator to northern latitudes. Due to this, deviation in sidelap happens at the equator. Therefore, the sidelap variation at equator is discussed here. The nominal sidelap at the equator would be 23.5 Km for LISS-III scene. The across track deviation would be of the order of ± 1.2 Km near the equator for LISS-III scene. Therefore, the two adjacent scenes of different cycles can be near by or away by twice this amount.

4.2.20 Accuracy of orbit and attitude parameters used for generating data products

In the earlier sections, the deviations and overlap sidelap variations of the actual scenes from the nominal scenes were described. Since orbit and attitude corrections are carried out continuously, during the mission, the information about the actual scene (deviating from the reference scheme) are known to the best accuracy possible only under operational environment. These information are used to generate browse, standard and other products. For browse products generation, one day predicted ephemeris with no attitude information are used, whereas, for standard products generation, definitive orbit and attitude parameters are used. The accuracy of different products are presented here.

Browse and Standard Products

Definitive orbit and attitude information are used for browse and standard products generation. The determination accuracy through S – band is expected to be 100 metres in position and attitude determination accuracy using star sensor is 0.014 degree in each of the axes. Therefore, the overall accuracy of the standard products in this case comes to 320 m. Use of a combination of position in SPS mode and attitude with star sensor, leads to the same location accuracy. But the combination of position in

GPS mode and star sensor based attitude provides 290 m location accuracy.

4.2.21 Impact of continuous yaw steering on LISS-III, LISS-IV and AWiFS

In LISS-IV, the even and odd CCD elements are staggered by five lines in each of the three CCD arrays. This means that on ground there is an along track separation corresponding to five lines between the images of the even and odd elements at a given instant. After the time corresponding to five lines, even pixels which are supposed to fit perfectly with odd pixels, will not do so because of earth rotation and there is a gap between even pixels and odd pixels. The effect of earth rotation depends on the latitude. It is maximum at equator and decreases with latitude. It could be compensated by yaw steering. The yaw required is maximum (4 degree) at equator. It goes on decreasing with latitude and it is almost zero at poles.

As discussed in section 4.2.17, the effect of yaw is to rotate the scenes (Figure 4.2.9). The maximum effect is at equator as the yaw applied is maximum there. In case of nadir payloads LISS-III and AWiFS, the corners 1 and 3 shift up and corners 2 and 4 shift down due to rotation. The maximum shift is 5 Km in case of LISS-III and 25 Km in case of AWiFS main scene. In case of LISS-IV mono scenes A and C embedded in LISS-III scene, the corners 1 and 3 shift up by 5 Km and there is little shift in corners 2 and 4 as they are close to the axis of rotation. In B and D the corners 2 and 4 shift down by 5 Km and there is little shift in corners 1 and 3 for the same reason as quoted above. But with tilt, the effect of yaw increases and at maximum tilt of 26 deg, the shift is around 30 Km.

The referencing scheme for all the payloads is generated considering the nominal yaw profile.

5.1 DATA PRODUCTS

5.1.1 Introduction

The philosophy behind the products identified for IRS-P6 mission is :

- * Provide continuity to existing products.
- * Exploit the capabilities of the sensors on-board
- * Introduction of additional features based on user feedback/requirements

Some of the new features in the products identified from IRS-P6 are :

- * Digital Data, apart from a default resolution, is provided in different resolutions for backward / contemporary data compatibility.
- * Additional resampling techniques, processing levels, file formats and media have been included.
- * All Geocoded and merged products have locational accuracies better than 100m.

Data products can be categorized as Standard products and Value Added products. Standard products are generated by applying radiometric and geometric corrections. Value added products are generated by further processing the standard corrected data.

The raw data recorded at the ground station is corrected for various levels of processing. Products are supplied on either photographic or digital media. Photographic products are supplied as films/paper prints and digital products on Digital Audio Tapes (DAT) and CD-ROMs.

5.1.2 Corrections applied to raw data

Raw data suffers from both geometric and radiometric distortions which have to be corrected. The various corrections applied are as follows:

5.1.2.1 Radiometric corrections

Each of the three sensors of IRS-P6 consists of linear

arrays with different number of detector elements. The response of the different elements of any of the arrays will not be exactly uniform. Radiometric correction is the process which normalizes these responses on the basis of the laboratory measured radiometric calibration values.

The steps for performing the radiometric correction are :

- * Detector normalization
- * Framing of required scene
- * Failed/degraded detector correction
- * Stagger correction for LISS-IV and SWIR bands of LISS-III and AWiFS
- * Line loss correction

Detector Normalization

All the sensors of IRS-P6 consist of linear arrays of a fixed number of detectors. The responses of these detectors for the same intensity of light falling on them are not identical. This non-uniform response leads to striping in the image data over uniform areas. This non-uniform response of the detectors is characterized in the laboratory in terms of a Radiometric Calibration Slope-Offset Look-Up Table (RADLUT). Using this RADLUT, the non-uniform response of individual detector elements is corrected. This correction is, thus, a mapping from the input gray value to an output gray value for each detector and over the entire range of the input gray levels.

Framing of the required scene

Area corresponding to the specified type of product is extracted in both scan line and pixel direction.

Failed/degraded detector correction

Some of the detectors in any of the CCD arrays can fail or degrade over a period of time. In such cases, the response of that particular detector is estimated from the response of the neighboring detectors. This

estimation is, however, possible only if the failed detectors do not exceed two consecutive CCD elements. Besides, during the mission life of the satellite, the detectors show varying degrees of degradation. This uneven degradation again leads to anomalies like striping in the image data. Such degradations are also corrected.

Stagger correction for LISS-IV and SWIR bands of LISS-III and AWiFS

The payload design of LISS-IV camera and SWIR band of LISS-III and AWiFS is such that the odd and even detectors are staggered by 5 scan lines and 2 scan lines respectively, in the focal plane. However, this stagger does not translate into a constant stagger in the image data. In fact, the stagger in the image data depends on the velocity of the satellite and the integration time of the sensor. Correction is performed to remove this stagger effect.

One dimensional resampling (vertical direction) is performed to construct the staggered pixels. Cubic convolution technique is used to reconstruct the staggered pixel.

Line loss correction

A line loss, in the transmission (assuming one sync corresponds to the integration time), will affect all detectors of the CCD array. This lost line can be identified and reconstructed. In case of loss of one line, the lost line is replaced by averaging the two neighbouring lines. If two lines are lost, the first line lost is recovered by repeating the previous line while the second line lost is recovered by repeating the next line. In case of three consecutive lines lost, the first line lost is recovered by repeating the previous line and the third line lost is recovered by repeating the next line. The second line is replaced by the average of the first and third line. The lost lines are not recovered in the case of more than three consecutive line losses.

5.1.2.2 Geometric Corrections

The data acquired by the satellite, have the following distortions :

- * Distortion due to the relative motion of the satellite with respect to the earth
- * Distortion due to Earth curvature
- * Panoramic distortion arising out of the tilt angles
- * Distortions arising out of the continuous yaw steering
- * Distortions due the staggered array of LISS-IV

Corrections are needed for removing the above mentioned distortions and projecting onto the user specified map projection in the desired datum. In view of the payload configuration, the different bands of LISS-IV are not registered on-board. In fact, the two extreme bands are separated on the ground by a distance equivalent to 2.1 seconds. This calls for ground based registration, which also effects the geometric corrections.

The distortions in the data from the satellite are corrected in two steps :

- * By establishing a mapping between the output space, as defined by the user.
- * By transforming the input data into this defined output space.

The user can request any of the different types of products supported. The output space for the product under consideration is defined and then a map is established from the 'output space' to the 'input space' (the scene under consideration). Resampling is the technique of generating an image on a system of coordinates, taking the input image from a different set of coordinates. This is needed, because, the satellite imaging is done at fixed time intervals, whereas the final product generation depends on the image being generated at regular spatial intervals. Hence, there is a need to shift the original samples of the image or interpolate between the input values,

to get the image samples at the output locations. This process is known as Resampling. More precisely, given the image intensities at a set of grid points, obtaining the same at a different set of grid points is known as Resampling.

Product Formatting

The corrected products containing the video data and the supporting ancillary information are organised in user specified format and written into the desired media.

There are five major product formats. Digital data product formats are discussed in Section 5.3.

1. GeoTIFF
2. Fast Format.
3. HDF (Hierarchical Data Format)
4. LGSOWG (Landsat Ground Station Operators Working Group), also called Super Structure Format (SS).
5. Photo Compatible Media (PCM) Format (for internal use only)

5.1.3 Product Types

Data products can be categorized as Standard products and Value Added products. Standard Products have system level accuracy, while Value Added Products have accuracies close to the accuracy of Ground Control Points (GCP) or scanned maps or templates which are used for precision correction. The various Standard and Precision Corrected Products made available to users are :

Standard Products

- Path/Row Based products
- Shift Along Track product
- Quadrant products
- Georeferenced products
- Basic Stereo pair

Value Added Products

- Geocoded products
- Template registered products
- Merge products
- Ortho products

5.1.4 Standard products

5.1.4.1 Path/Row based products

These products are generated based on the referencing scheme of each sensor. The user has to specify the path/row, sensor, sub-scene, date of pass, band number/band combination (for photographic products) and the product code as inputs.

5.1.4.2 Shift Along Track (SAT) products

If a user's area of interest falls in between two successive scenes of the same path, then the data can be supplied by sliding the scene in the along track direction. These are called Shift Along Track products. In this case, the percentage of shift has to be specified by the user in addition to the inputs specified for path/row based products. The percentage of shift has to be between 10% and 90% in multiples of 10%. Figure 5.1.1 explains the concept of a SAT product.

5.1.4.3 Quadrant products

These products are applicable only to LISS-III sensor. The LISS-III full scene is divided into four nominal and eight derived quadrants (Figure 5.1.2). As seen from the Figure, quadrant numbers 1 to 4 are nominal quadrants. The remaining eight quadrants are obtained by sliding quadrants 1,2,3 and 4 by 25% along and across the scene, within the path. LISS-III photographic quadrant products are generated on 1:125,000 scale. While placing a request for these products, users need to specify the quadrant number and shift if any, in addition to the details specified for path/row based products.

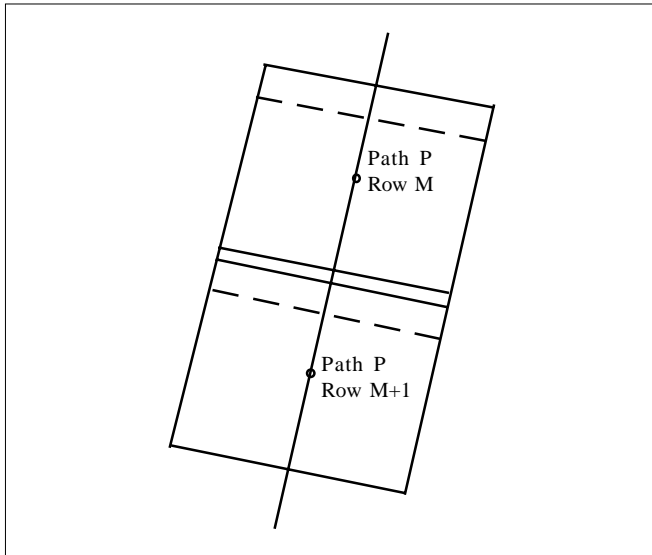

Figure 5.1.1 Concept of a SAT product.

5.1.4.4 Georeferenced products

These are true north oriented products. These products are supplied on digital media only. The locational accuracy of these products is same as standard products viz., better than 450m. The inputs

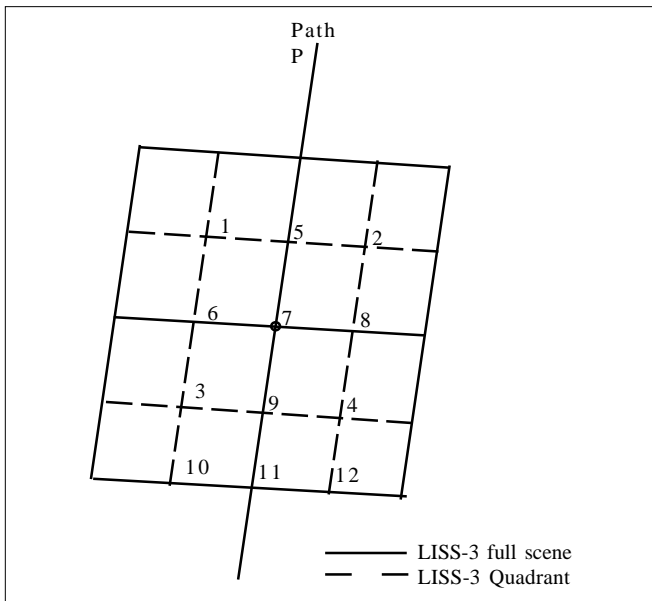

Figure 5.1.2 LISS-3 Quadrants

to be supplied are same as path/row based products with appropriate product code.

5.1.4.5 Basic Stereo products

The oblique viewing capability of LISS-IV sensor can be used to acquire stereo pairs. A stereo pair comprises of two images of the same area, acquired on different dates and from different angles.

One of the parameters from which the quality of a stereo pair can be judged is the base/height (B/H) ratio. B/H ratio is the ratio of distance between two satellite passes and satellite altitude (Figure 5.1.3).

Stereo products are available from LISS-IV Mono mode only. The inputs required, in addition to path/row details is B/H ratio. Two scenes selected on two different dates, satisfying the user's B/H ratio are supplied as a stereo pair. The data is only radiometrically corrected and are supplied on digital media.

5.1.5 Value Added Products

5.1.5.1 Geocoded Products

Geocoding corrects the imagery to a source independent format, whereby multi-date and multi-satellite data can be handled with ease. Geocoded products are generated after applying radiometric and geometric corrections, orienting the image to true north and generating the products with an output resolution, appropriate to the map scale (in the case of photographic products). Both floating and Survey of India (SOI) map sheet based products are supplied. All geocoded products are supplied as one product (no split map sheet data as in the case of IRS-1A/1B).

The planimetric accuracy of Geocoded products in 1:50,000 scale is better than 100m.

5.1.5.2 Merge Products

Merge products are generated by merging LISS-III data with LISS-IV data in Mono mode. The

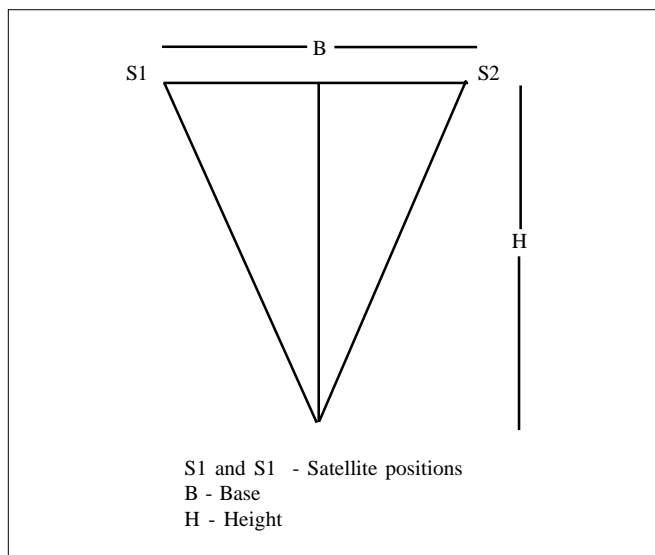

Figure 5.1.3 Concept of stereo pairs

two data sets are first registered and then merged. The registration is based on an automatic technique for selection of control points based on feature contrast and finding match points through digital correlation. The merging of registered data is performed using the Wavelet technique. The high resolution LISS-IV image is wavelet decomposed for two levels using the cubic-spline wavelets to obtain a low resolution image corresponding to the LISS-III resolution and 6 detail components corresponding to high frequency information. The LISS-III image is combined with these detail components and the wavelet recomposed to obtain the merged images. While this is the default merging technique used, other techniques are used whenever required.

5.1.5.3 Ortho products

Orthoimages are geometrically corrected products with corrections for displacement caused

by terrain and relief. In other words, it is a picture prepared in such a manner that the perspective aspect of the picture has been removed.

Hence orthoimage is an image that shows ground objects in their true map or so called orthographic projection. An orthographic projection is the one in which the projecting rays are perpendicular to the plane of projections. Any part of the object that is parallel to the plane of projection will appear in its proper shape and correct scale. These properties of the orthoimage enable it to be used as a map for the measurement of distances, angles, areas etc., with scale being constant everywhere. They can also be used as map layers in geographic information systems or other computer based data manipulation, overlaying, management and analysis or display operations. However, orthoimage differs from a map in the manner of depiction of detail. On a map, only selected detail is shown by conventional symbols, whereas on an orthoimage all detail appears just as in the original satellite image. On the other hand satellite image without terrain correction differs from the orthoimage, in scale variation due to height and tilt distortions.

The basic inputs required for orthoimage generation are (i) Digital Elevation Model (DEM), (ii) Ground Control Points (GCP) (iii) Satellite ephemeris (orbit, attitude information) and (iv) Radiometrically corrected image data.

5.1.5.4 Template registered products

AWiFS sensor is envisaged for extensive use in crop monitoring. This can be facilitated by having data sets belonging to the same area, having similar geometric fidelity and temporally registered. Such data sets are called templates in IRS-P6 context. These templates are used, as reference images to register the AWiFS scene data. The template space is a fixed spatial reference grid over India. Full India space is overlaid with 1 deg X 1 deg template grid and each grid can be uniquely identified by a number.

5.1.6 Product options

The various levels of correction, map projections, ellipsoids, resampling kernels, output Resolutions, output media and digital data product formats are given below.

Levels of Corrections supported

Level	Type of Correction
Level-0	No correction (Raw)
Level-1	Radiometric correction
Level-2	Radiometric and Geometric correction (Standard)
Level-3	Precision correction using GCPs

Map Projections

User will be able to define any of the following map projections for the product type Level 2 / Level 3

- Polyconic (P)
- Lambert Conformal Conical (L)
- Universal Transverse Mercator (U)
- Space Oblique Mercator (S)

Earth Ellipsoids

Data Products can be supplied in the following ellipsoids for geometrically corrected products.

- Clarke 1866 (C6)
- International 1909 (I9)
- GRS 1980 (GR)
- Everest (EV)
- WGS – 84 (W4)
- Bessel (BL)
- Krassovsky (KW)

Resampling Options

Following resampling options are available for geometrically corrected products.

- Cubic Convolution (C)
- Nearest Neighbour (N)
- 16 Point Sinc (S)
- Kaiser-16 (K)

Output Resolutions

Geometrically corrected digital products can be provided with different output resolutions. However, operationally standard output resolutions are used for product generation.

LISS – 4	3.125 m to 6.25 m
LISS – 3	12.5 m to 25 m
AWiFS	50.0 m to 75 m

Output Media

Data Products are supplied on the following output media

- 8mm DAT
- CD-ROM
- Photo product (B/W and FCC)

Digital Data Product formats

Digital Data are supplied in the following formats

- LGSOWG Superstructure Format
- Fast Format
- GeoTiff-Gray Scale
- GeoTiff-RGB
- HDF

The details of the various products supplied from LISS-III, LISS-IV and AWiFS sensors are summarized in Tables- 5.1.1 to Table – 5.1.4.

Product Radiometric Accuracy

This is defined by signal-to-noise ratio (SNR) of the payload, measured as the standard deviation of data products for a uniform homogeneous terrain feature.

Sr No	Product Type	Level Of Correction	Area Covered (Km x Km)	No Of Bands	Output Type
1	Path-row based *(with & without shift) product	i) Raw	141 x 141	4	Digital
		ii) Radiometrically corrected	141 x 141	4	Digital
		iii) Standard	141 x 141	3	Photographic
		iv) Geo Referenced	141 x 141	4	Digital
2	**Floating quadrant product	Standard	70 x 70	3	Photographic
				4	Digital
		Geo Referenced	70 x 70	4	Digital

* Shift : Scene can be shifted along the track from 10 % to 90 % of the scene size in steps of 10 %.

** Quadrant : Twelve quadrants, similar to IRS-1C/1D

Table 5.1.1 LISS-III Standard Products

Radiometric accuracy is specified in terms of the following parameters

- Relative Radiometry

SNR across the uniform scene
SNR local for any 16 x 16 pixel sub-image
Spectral Response of the detectors across CCD array

- Absolute Radiometry

Verification with in-situ ground truth data

Location Accuracy for System corrected Products

* Star sensor attitude and Satellite Position system (Prime Mode): 150 m (1s)

* Earth sensor attitude and Satellite Position system (Backup Mode) : 450 m (1s).

Sr No	Product Type	Level Of Correction	Area Covered	No Of Bands	Output Type
1	Scene based	Standard	23 x 23 Km	3Mx bands	Photographic / Digital
			70 x 70 Km	Mono	Digital / Photo
		Geo Referenced	23 x 23 Km	3Mx bands	Digital
			70 x 70 Km	Mono	Digital
4	Basic stereo pair	Radiometrically corrected	70 x 70 Km	Mono	Digital

Table 5.1.2 LISS-IV Standard Products

Sr No	Product Type	Level Of Correction	Area Covered	No Of Bands	Output Type
1	Path row based (with & without shift)	Raw	370 x 370 Km	4	Digital
		Radiometrically corrected	370 x 370 Km	4	Digital
		Standard	370 x 370 Km	3	Photographic
				4	Digital
Geo referenced	370 x 370 Km	4	Digital		

Table 5.1.3 AWiFS Standard Products

Sensor	Product Type	Level Of Correction	Area Covered	No Of Bands	Output Type
LISS-III	Geocoded	Precision	15' x 15'	4 3	Digital Photo
	Ortho Image	Ortho Rectified (GCP + External DEM)	15' x 15'	4 3	Digital Photo
LISS-IV	Geocoded	Precision	7.5' x 7.5'	3	Digital/Photo
			15' x 15'	Mono	Digital/Photo
			5' x 5'	3	Digital/Photo
	Ortho Image	Ortho Rectified (DEM Generation)	7.5' x 7.5' (Stereo graphic)	Mono	Digital/ Photo
		Ortho Rectified (External DEM)	7.5' x 7.5'	Mono	Digital/Photo
		Ortho Rectified (External DEM)	15' x 15'	Mono	Digital/Photo
AWiFS	Geocoded	Template Registered	1° x 1°	4	Digital
	Standard/ Geo-Referenced	Standard	740 x 740 Km*	4	Digital
LISS-III+	Geocoded	Merge	15' x 15'	3	Photo/Digital
LISS-IV	(Mono)		70 x 70 Km	3	Photo/Digital

* To be introduced in the second phase

Table 5.1.4 Value Added Data Products

5.2 PHOTOGRAPHIC PRODUCTS

As mentioned in the earlier section, photographic products are available as B/W and FCC paper prints. Figure 5.2.1 gives the layout of photographic products.

This section describes the image annotation of photo products. The annotation format of photo product gives information about the scene. The geocoded product annotation format is nearly the same as that of standard products, since, most of the geocoded products are supplied as a single product.

The annotation format has two lines on the top of the image data and one annotation line, at the bottom of the data (Figure 5.2.2).

The first line of annotation at the top gives details of the satellite, the type of product i.e., if the scene is fixed or shift along track, details of area covered i.e., Full/Quad/Geo, indication whether the data is OBSSR data, band numbers, Gain settings, details

about the product whether it is path based, topo sheet number, details regarding the projection i.e., POL (other options being SOM/LCC/UTM) and the resampling technique used i.e., CC/NN/BL etc.,.

The second line of the annotation at the top gives details regarding the date of acquisition with time, path/row details, sensor, sub-scene details, quadrant number (the other option being percentage of shift), look angle information on the Sun Elevation and Azimuth in degrees.

The annotation line at the bottom of the image gives details regarding the generation-ID, date of generation with time, the type of enhancement used i.e., details about which DPS chain generated the product, place of generation, details regarding the DPS usage and the information about the product generation agency. This annotation line is for internal use only.

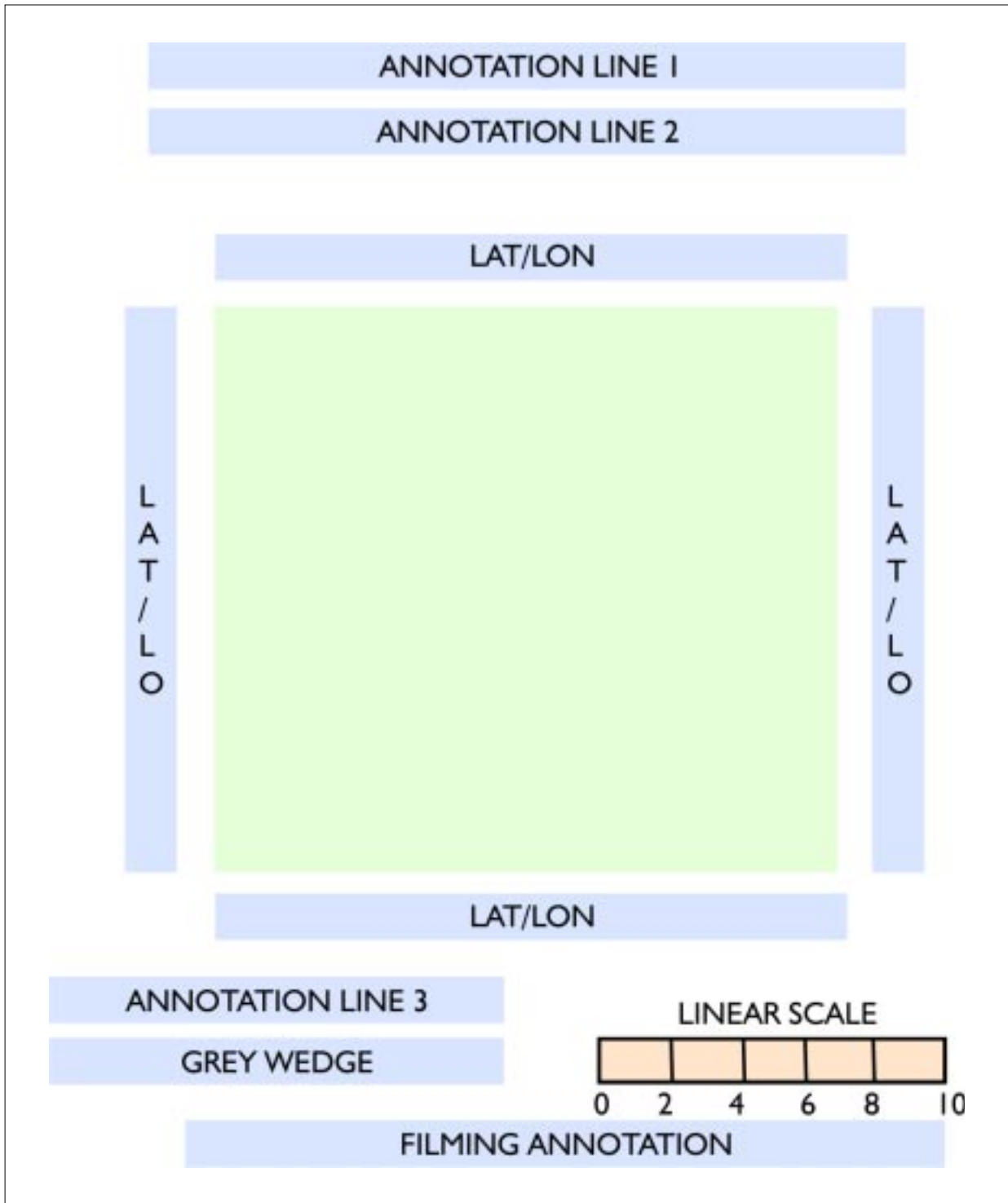

Figure 5.2.1 Layout of Photographic products

ANNOTATION LINE NUMBER 1 (TOP)

IRS-1C	STD	FIXED	FULI	OBSR	BANDS	GAINS	PATHBASED	RESOL	POL	CC
A	B	C	D	E	F	G	H	I	J	K

CODES:

- A Satellite_id
- B Product type (other options are geocoded/merged/stereo)
- C Other options is float
- D Other options are India/Geo
- E This space will be left blank if the product is not a OBSSR product
- F Band number details
- G Gain settings
- H Other options are stereo pair(1/2)/merged/ orthoimage /point based/map sheet number
- I Resolution
- J Type of projection (other options are SOM/UTM/PS/LCC)
- K Type of re sampling

ANNOTATAION LINE 2 NUMBER (TOP)

10APR96/10;30;10	P102/R025	L3 A0 QU:12	LA+15:30	FN:25-30-10/E72:30:45	E:90-A14
------------------	-----------	-------------	----------	-----------------------	----------

A	B	C	D	E	F	G	H
---	---	---	---	---	---	---	---

CODES:

- A Date of acquisition with time
- B Path-Row details or strip-scene details for LISS-IV
- C Sensor details (other option is 'L4' for LISS-IV and 'AW' for AWiFs)
- D Subscene details (applicable in case of LISS-IV and AWiFS products)
- E Quadrant number (other option is percentage of shift)
- F Look angle in degrees
- G Corrected scene centre lat/long coordinates(Deg-Min-Sec)
- H Sun elevation and azimuth(Deg)

* Annotation line number 2 (top) will be repeated as annotation line number 3 (top), in case there is more than one scene and annotation line 3 will become line number 4.

ANNOTATION LINE NUMBER 3 (BOTTOM)

XT:12345	PROC ON:31-MAY-1996/22;40;10	NOLUT	DPC-I	HYDERABAD	DPUSAGE	ISRO/NRSA
----------	------------------------------	-------	-------	-----------	---------	-----------

A	B	C	D	E	F	G
---	---	---	---	---	---	---

CODES:

- A Generation_id
- B Date of generation
- C Enhancement (other option are CLUT/HLUT/EQLUT)
- D DPS chain at which the product was generated
- E Place of generation
- F DPUsage, this is for internal purpose only
- G Data generation agency

Figure 5.2.2 Annotation details

5.3 DIGITAL DATA FORMATS

5.3.1 Introduction

Digital data are supplied on media like CD-ROMs and 8mm Exabyte tapes based on the user request. The formats in which the digital data are supplied are Fast, LGSOWG (Superstructure), Geotiff (gray and RGB) and HDF formats.

Additional fields have been added in LGSOWG format. The fast format of IRS-P6 digital products is same as IRS-1C/1D fast format. Data in GEOTIFF format is provided in both gray as well as RGB format. Additional digital format requirements such as ERDAS (.img) AUTOCAD (.dwg), mapinfo can be derived from the GEOTIFF format using any standard Image Processing software.

5.3.2 LGSOWG Format

The difference between LGSOWG and Fast format is that, in addition to the Video data, LGSOWG format has ancillary information on location, sensor, platform and processing. In LGSOWG format, there is only one Directory – Product1 and a CDINFO file. In the Product1 directory, there are five files.

Volume directory file
 Leader file
 Image data file
 Trailer File
 Null volume file

Logical volume : A logical volume is a logical collection of one or more files recorded consecutively. A logical volume contains one or more band data of a scene. All logical volumes have a volume directory as a first file and are concluded with a null volume directory. When a video data is split into physical volumes, the volume directory is repeated in the second volume also.

Volume directory : The volume directory file is the first file of every logical volume. It is composed of volume descriptor record, a series of file pointer

records and a text record. The volume descriptor record identifies the logical volume and the number of files it contains. Text record identifies the data contained in the logical volume. There is a file pointer record for each type of data in the logical volume which indicates each file class, format and attributes.

Leader file : The leader file is composed of a descriptor record and two types of data records. The data records are header and ancillary. Header record contains information related to mission, sensor, calibration coefficients and processing parameters. Ancillary records contain information pertaining to ephemeris, attitude, map projection, GCPs for image correction and image location and annotation.

Image file : Image file consists of a file descriptor record and actual image record. Image data contain actual video data in BIL or BSQ format. In addition to the image or video data, it also contains pixel count, scan line identification, starting and ending of actual data in the line.

Trailer file : The trailer file shows the calibration data file and ancillary information file. This is composed of a file descriptor record and one trailer record for each band.

Null volume directory file : The file which terminates a logical volume is null volume directory file. The file is referred to as “NULL” because it identifies an existent logical volume. This file consists of a volume descriptor record only.

CDINFO: This file contains information of number of lines, pixels, Record length and other scene related information like path/row.

New Elements in LGSOWG

Keeping in mind the issue of AWIFS head to head alignment and LISS –4 band to band registration, the following new fields have been introduced in the image data part of leader file :

1. Indication of Header bands (B2- B3, B3- B4 , B2- B4)
2. Skew angle
3. Pixel offset (pixel overlap in case of AWIFS and starting pixel offset in case of LISS-IV)
4. Scan line Offset

Fields 2,3,4 have to be repeated for each head/band combination. For each sensor these fields have corresponding values.

5.3.3 Fast Format

In Fast format in addition to the image data, one Header file is provided.

Header file: This is the first file on each volume and contains header data in ASCII format. It contains information on map projection, resampling options and tick marks.

Image File : It contains only Video data. There is no prefix and suffix data with individual image record.

5.3.4 GEOTIFF Format

The GEOTIFF product is a set of tiff tags provided to describe all cartographic information associated with TIFF imagery that originates from satellite imaging systems. GEOTIFF uses a small set of reserved TIFF tags to store a broad range of geo-referencing information, catering to geographic data interchange standards, but rather aims to augment an existing popular raster – data format to support geo-referencing and geocoding information.

GEOTIFF format for IRS-P6 data products supports both gray and Red, Green and Blue (RGB) model for data storage.

5.3.5 Hierarchical Data Format (HDF)

The Hierarchical Data Format (HDF), is the standard data storage format selected by the Earth Observing

System Data and Information System (EOSDIS) Core System (ECS) [5]. HDF is developed and maintained by the National Center for Supercomputing Applications (NCSA) at the University of Illinois at Urbana Champaign. EOSDIS has defined an extension called HDF-EOS that establishes standards for storing EOS data and for applying search services to these data .

Broadly speaking, HDF has been designed to allow sharing of self-describing files across heterogeneous platforms. “Self-describing” means that a data set, such as a multidimensional array of numbers, can have additional metadata logically associated with it that describe things such as the rank of the array, number of elements in each dimension, etc. The ability to access files across heterogeneous platforms is a powerful capability that allows one to read files generated on a different machine architecture. For example, a user with a DEC ALPHA machine can read an HDF file generated on a Silicon Graphics machine where ordinarily the byte ordering of binary files would need to be considered. The HDF library functions take care of such details.

To achieve the above capabilities, HDF borrows the principles of object-oriented programming. Multidimensional arrays, tables and images can be stored in the same file and viewed as discrete objects, rather than a continuous stream of bits. A knowledge of object-oriented programming and of the physical layout of the files is unnecessary because users interact with these objects only through calls to an HDF library. Rather, the user needs to understand the content of the file being accessed in terms of the various HDF and HDF-EOS data object types.

HDF Data Objects

The following data objects are supported by HDF to store science and calibration data and associated metadata, which describe the scope and quality of science data :

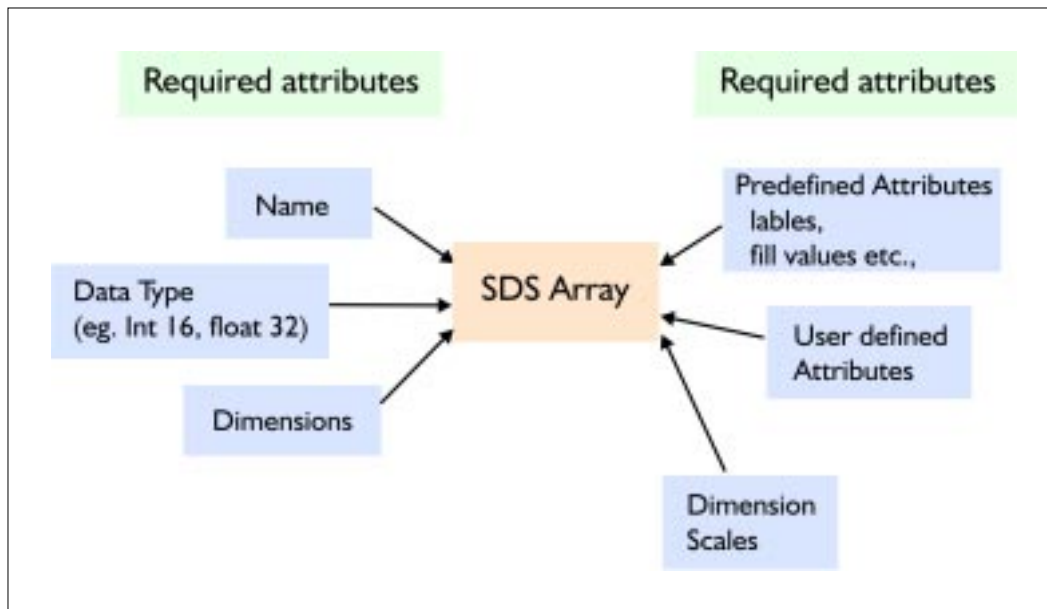

Figure 5.3.1 Schematic of the required and optional components (attributes) of an SDS. The required components are shown on the left side of the figure, and the optional components are shown on the right.

Scientific Data Sets (SDSs)

These objects contain multidimensional arrays, used to store scientific data, their uncertainties, The SDSs are made self-describing through a set of attributes - data that may be considered “attached” to the SDS. Figure 5.3.1 shows a schematic of the components of an SDS.

The required attributes listed below provide the minimum information to allow an HDF library to identify the SDS, and organize the data in it into an array having the correct dimensions and data type:

- * SDS Array : Multidimensional data structure
- * Name: A string that defines the name of the SDS and uniquely identifies it.
- * Data Type: Type of data (e.g., float 32) that defines how the data in the array are stored.
- * Dimensions: The number of dimensions, or rank, of the array.

All other attributes are optional attributes, as follows: Predefined attributes, including but not limited to:

- Labels for all dimensions and for the data
- Units for all dimensions and for the data
- A range specifying maximum and minimum values for the data set.
- A fill value for representing missing data in a data set.
- The coordinate system to be used when interpreting or displaying the data

User defined attributes:

Dimension scales:

Scales to be used along the different dimensions when interpreting and displaying the data.

Virtual data (Vdata)

A Vdata can be thought of as a table that consists of a collection of records whose values are stored in fixed-length fields. All records have the same structure and all values in each field have the same data type, in the same way that a database organizes records. Vdata are uniquely identified by a name, a class, and a series of individual field names, as follows:

Name: A label describing the contents of a vdata as a whole.

Class: Further distinguishes a particular vdata by identifying the purpose or the use of its data.

Field names: Labels assigned to the fields in the vdata.

Fields: Assigned a data type and order when the vdata is created. Permitted data types are : character, 8-bit, 16-bit, and 32-bit integers (signed and unsigned) or 32-bit and 64-bit floating point numbers. The order identifies the number of individual words of the particular data type which reside in the field.

File (Global) Attributes

In addition to describing features of an SDS, HDF attributes can also describe the contents of a file as a whole.. The HDF-EOS extension of HDF makes use of two special examples of global attributes to meet the requirements of EOS.

EOS has satisfied these requirements in the following fashion and implemented them in the HDF-EOS library [6]:

A means of providing system wide search services. Special metadata summarizing temporal and spatial coverage of the data, data quality, and attributes.

A means of storing geolocated data in remote

sensing missions. The swath datatype is designed to store data

Overview of the HDF-EOS Swath Structure

The Hierarchical Data Format (HDF) is the standard data storage format selected by the Earth Observing System Data and Information System (EOSDIS) Core System (The purpose of the swath is simply to anchor science data to specific points on the Earth's surface. The swath consists of four parts:

Data fields, including science (earth view) data;
 Geolocation fields, which allow the swath to be tied to points on the earth's surface;
 Dimensions, which define the axes of data and geolocation fields, and
 Dimension maps, which define the relationship between the data fields and the geolocation fields. When the geolocation dimensions have a different size than the data dimension, an offset and an increment define the relation between them. These maps have been described as "the glue that holds the swath together."

The swath structure global attribute is used by HDF-EOS library functions to organize calibrated data into the swath structure. This attribute should never be read directly by the user. HDF-EOS tools and libraries read the Swath Structure attribute to interpret the relationship between science and geolocation information. Calls to HDF-EOS swath routines are needed only to access data tied to specific regions on the surface of the Earth. Ordinary HDF tools, such as those supplied by NCSA, can read the individual science and geolocation SDSs, but cannot interpret the relationship between them.

IRS-P6 data products in HDF file structure

Digital data can be supplied using HDF-EOS swath structure for handling multi-band remote sensing data collected by IRS-P6. Only full system corrected, level-2 (radiometrically and geometrically corrected)

products are supplied in HDF format. The output file that each product contains is determined by the sensor, band number, product type etc., as per user request. Each file has the following components.

- HDF directory file
- Digital image file (for each requested band)
- Product metadata file

File naming convention

The HDF files are packed and distributed as a collection of external elements with an HDF directory. Information about HDF structure and interrelationship can be found in the HDF directory.

The file naming convention for the HDF product file is

IP6ppprrrYYYYMMDD_AAA.XXX(Total 25 characters)

Where IP6 = IRS P6 mission
 ppp = Starting path of the product
 rrr = Starting row of the product

YYYYMMDD = Acquisition date of the image
 AAA = File type
 Bon where n is the band number
 HDF = HDF directory
 MTL = Product metadata

HDF directory file

The directory file contains all pointers, file size information and data objects required to open and process the product using the HDF – EOS library and interface routines.

Digital image file

Each image band is contained in a separate HDF-EOS swath file.

Band Data file – swath format overview

A data product image band file contains a single swath object. Each band file contains a swath object consisting a set of data fields, dimension information on each of the data and geo location fields, and mapping of the geo location fields to the data fields. Within the data products band file swath context, the band detector data (DN values) corresponds swath data field and information about the band detector data . The dimension information associates each geo location field to data field dimensions. The WRS scene related geo location fields, consisting of calculated actual scene center and corner latitudes and longitudes are associated with the band data dimensions using a list indices. An index map provides selected mapping between geo location fields and scan data lines. This mapping is used to provide scene center and corner reference points in the band data swath.

Band data file – grid format overview

The grid data set is similar to swath in that it contains a series of data fields of two but the main difference between grid and swath is the character of their character of geo location information. There are three important features of a grid data set : the data fields, the dimensions and the projection.

Data fields

Data field is grid data set are rectangular array of two or more dimensions. A single set of geo location information is used for all data fields within one grid data set.

Dimensions

Dimensions are used to relate data fields to each other and to the geo location information.

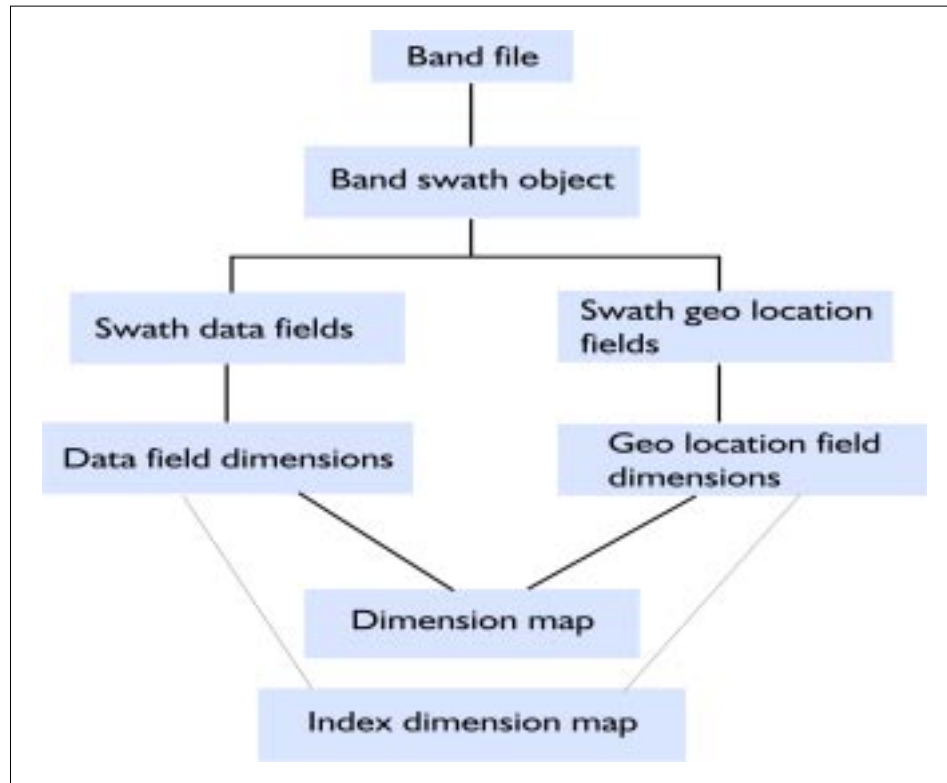

Figure 5.3.2 HDF structure and inter- relationship

Projections

The projection is really the heart of the grid. Without the use of a projection the GRID would not be substantially different from the swath. The projection provides a convenient way to encode Geo location information a set of mathematical equations, which are capable of transforming Earth coordinates (latitude and longitude) to XY coordinates on a sheet of paper.

Only six projections are supported by HDFEOS in IRS-P6 - Geographic, Interrupted Goode's Homolosine, Polar stereoscopic, Universal Transverse mercator, Space oblique and Lambert Azimuthal equal area. User can select his choice of projection by keeping in mind the basic characteristics of each projection.

Product metadata field

The product metadata field is in ODL format. This contains basic information (ex. Satellite name, Sensor, Date of Pass, Path Row etc.,) radiometric parameters (ex. CCD temperature, Gain, Saturation radiance etc.,) and Geometric parameters (ex. Latitude, Longitude, Map projections/ellipsoids etc., used to generate corrected image file.

6.1 INTRODUCTION

During the recent past, NRSA has introduced a number of services, in tune with the emerging trends in technology. NRSA has introduced the Digital Browse Facility through Internet, product delivery through ISDN and FTPsite. During IRS-P6 time frame NRSA has come out with the additional service of data ordering through net. Data ordering was, traditionally, done either by filling up the paper order form and sending by post or by sending a FAX message.

With the introduction of the electronic ordering system integrated with browse and payload

programming systems, users can browse, select and order data online. Also facility to obtain the status of the user accounts and requests is made available online. While this takes care of data ordering, introduction of data delivery through network ensures that data reaches the users with the best turn around time possible in case of emergency.

Required information on how the various users - both Indian and Foreign - can procure IRS-P6 data is also discussed.

6.2 USER ORDER PROCESSING SYSTEM

6.2.1 Introduction

The User Order Processing System is an integrated web based application which facilitates data browsing and ordering through network for archived data and requesting for programmed acquisition (Figure 6.2.1).

Users, after browsing the images using the various queries discussed in Section 6.3 and selecting the scenes, can place an order for the same using the ordering tolls. Facility to obtain the status of user accounts and the orders placed is also available online. Registered users can also change their details like address and their login password and send general queries through e-mail.

6.2.2 User order processing

Upon connecting to the NRSA User order processing system site, the user is presented with a page with various links which enable the user to navigate through the application (Figure 6.2.2). If the user is new, he has to register himself for the ordering service to be enabled. While registering, the user has to agree to the terms and conditions displayed. A registration form is displayed in which he has to provide details like name, user identification (uid), password, user category, mailing address etc.,. Users have to remember their uid and password for future logins.

If the user is a registered user, he can sign in with his uid and password and enable the services.

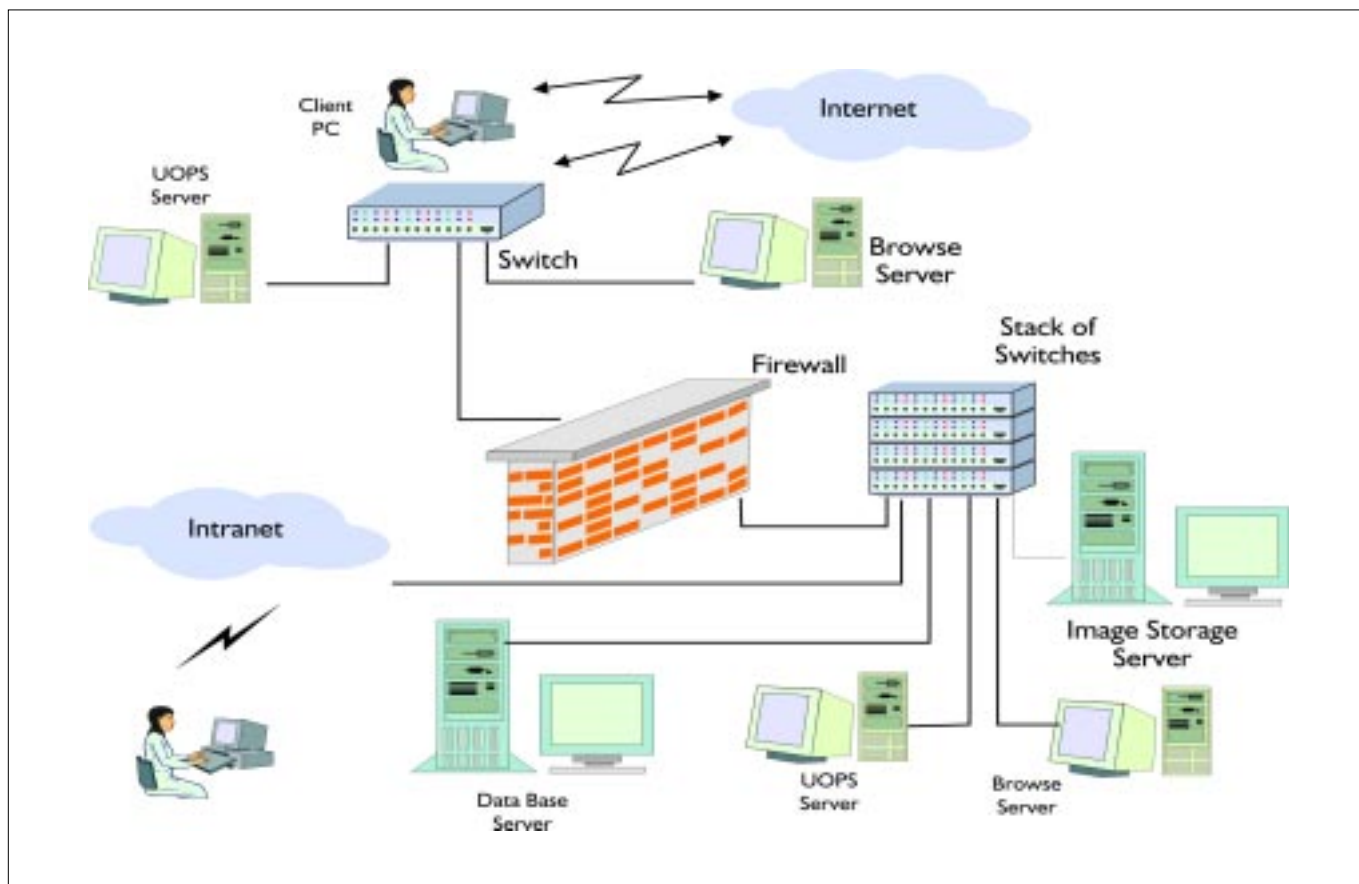

Figure 6.2.1 Block diagram of User Order Processing System



Figure 6.2.2 UOPS Home page

6.2.3 Services

The various services include data selection tools, ordering tools, order status display, request for restart of an order, product catalogue display and accounts related services (Figure 6.2.3). We shall now see how each of these can be used in selecting and ordering data.

After selecting the required scenes using the data selection tools, users have to click the order placing link. The user is presented with a form in which he has to select the account number under which he would like to place the order. Once the account number is provided, all the scenes selected by the user using the data selection tool are displayed. In addition to the scenes already selected by him, if the user wants to add some scene details, he can do

the same by selecting the manual entry link (Figure 6.2.4). The manual data entry form is given in Figure 6.2.5.

For each of the scenes selected, user has to select the output media. Once the output media is selected, additional product information like map projection, enhancement, format, sampling technique, bands, correction level, quantity, priority and delivery mode in the case of digital products are requested for (Figure 6.2.6).

Depending on the type of product, further information like percentage of shift in the case of shift along the track products and map sheet number in the case of geocoded products is requested.

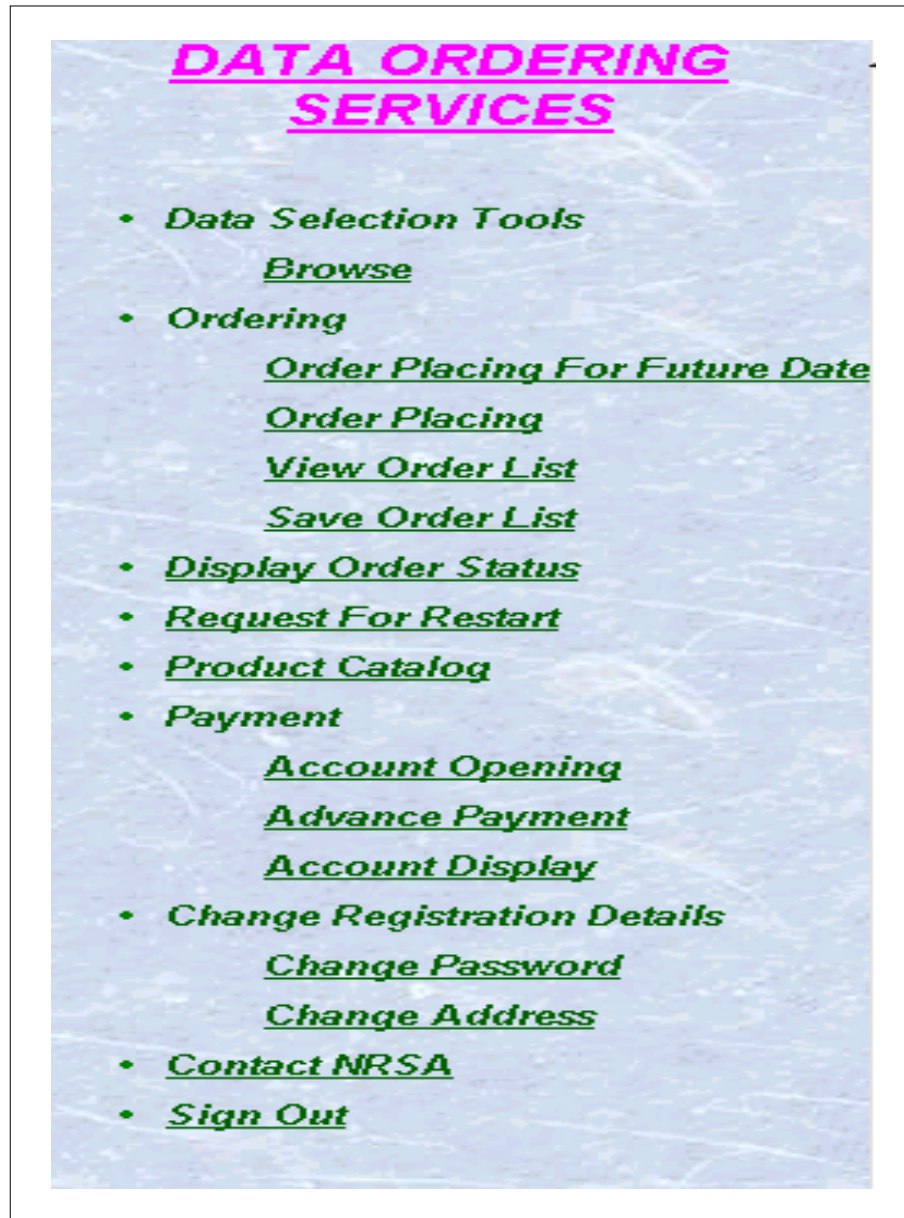

Figure 6.2.3 Page displaying the UOPS Services

On providing the above information, a form displaying all the details of the products requested is displayed (Figure 6.3.7). At this stage, the user can confirm the request or add some more products to the list. Option to save the selected

products is available. This can be done using the 'save order list' option.

The products can be sent to different shipping addresses (Figure 6.3.8). All the products from the list of selected products for a given shipping address,

DATA ORDERING SERVICES

- [Data Selection Tools](#)
 - [Browse](#)
- [Ordering](#)
 - [Order Placing For Future Date](#)
 - [Order Placing](#)
 - [View Order List](#)
 - [Save Order List](#)
- [Display Order Status](#)
- [Request For Restart](#)
- [Product Catalog](#)
- [Payment](#)
 - [Account Opening](#)
 - [Advance Payment](#)
 - [Account Display](#)
- [Change Registration Details](#)
 - [Change Password](#)
 - [Change Address](#)
- [Contact NRSA](#)

ORDER PLACING

[Help](#)

	Select	Satellite	Sensor	Scene Id	Date of Pass	Path	Row
<input type="checkbox"/>	1C	LIS3			01-JAN-2002	097	045
<input type="checkbox"/>	1D	PAN	B4		01-MAY-2002	093	044

Media Type:

To Manually Enter Scene Details [Click Here](#)

Figure 6.2.4 Page displaying the list of scenes selected

Manually Enter the Scene Details

[Help](#)

Enter the Scene Details

Satellite: **Sensor:**

Only If "PAN" is Selected.
Select the Scene and the Subscene No. For FullScene select the subscene No "0"

Scene: **Sub Scene No:**

Date Of Pass: **Path/Orbit No:** **Row/Sector No:**

Figure 6.2.5 Form for manual data entry

ORDER PLACING

[Help](#)

Select	Satellite	Sensor	Scene Id	Date of Pass	Path	Row
<input checked="" type="checkbox"/>	1C	LIS3		01-JAN-2002	097	045
<input type="checkbox"/>	1D	PAN	B4	01-MAY-2002	093	044

Media Type:

To Manually Enter Scene Details [Click Here](#)

Product Type: **Balance in Account:** 0000200

Projection: <input type="text" value="POLYCONIC"/>	Sampling: <input type="text" value="CUBIC CONVOLUTION"/>
Enhancement: <input type="text" value="No Enhancement"/>	Correction Level: <input type="text" value="BULK"/>
Format: <input type="text" value="LGSOWG BIL"/>	Media: <input type="text" value="CD ROM"/>
Bands: All Bands	Delivery Mode: <input type="text" value="COURIER"/>
Quantity: <input type="text" value="01"/>	Priority: <input type="text" value="WITHIN 3 DAYS"/> <small>[SEE ADDITIONAL CHARGE]</small>

Figure 6.2.6 Product option selection form

are treated as one order. This way the list of selected products can result in more than one order, possibly with different shipping addresses. A page with all the information pertaining to an order is displayed (Figure 6.2.9).

Status of the order can be viewed online using the 'Display order status' option (Figure 6.2.10).

In case the user has any complaints regarding the dispatched products, he can use the 'Request for restart' option to intimate the same by selecting the product request and giving the reason.

A list of the product codes and the cost of each for a given satellite and sensor can be obtained using the 'Product catalog' option.

User accounts related information also can be obtained online. Provision exists for a new user to

request for opening an account online by clicking the 'open new account' option.

An off-line user is one who has one or more account numbers with NDC but has been placing orders for data by filling a paper order form or by FAX. Such off-line users can transfer their existing accounts to the newly registered uid using the 'off-line user' option

Details of the advance payments made can be sent using the 'Advance payment' link (Figure 6.2.11).

Accounts and transaction details can be viewed using the 'Account display' option (Figure 6.2.12).

Registered users can change their address and password using the 'Change Address' and 'Change password' options. Any further correspondence can be made using the 'Contact NRSA option'.

ORDER PLACING

[Help](#)

SI No Of Scenes	Satellite	Sensor	Subscene Number	Date of Pass	Path	Row	Product Code
1	1C	LIS3		01-JAN-2002	097	045	STPC0027J
1	1D	PAN	B4	01-MAY-2002	093	044	STPC0027J

[Confirm the requests](#)
[Place another Request](#)

Figure 6.2.7 Page displaying selected products

CONFIRM THE REQUESTS

Help

SI No	Select	Of Scenes	Satellite Sensor	Subscene Number	Date of Pass	Path Row	Product Code	Band Type	Bands Quantity	Dispatch Mode	User Priority	Request Value	Sluff Percentage	Quadrant No	Mapsheet No	Mapsheet Quadrant	Mapsheet Datum	Corner Area	Latit
1	<input checked="" type="checkbox"/>	1	IC	LIS3	01-JAN-2002	097	045 STP00271		01	COURIER	IDAY	12156.0
1	<input checked="" type="checkbox"/>	1	ID	PAN	01-MAY-2002	093	044 STP00271		01	COURIER	IDAY	20000.0

SHIPPING ADDRESS DETAILS

The fields marked * are mandatory.

*
 *

*
 *

*
 *

*
 *

*
 *

Figure 6.2.8 Form seeking shipping address details

ORDER AND REQUEST DETAILS																								
<p>Order Number: 16 Order Date: 25-Jul-2003 The Estimated Order Value: 12156.0 The Account Number: 0000200</p>																								
PRODUCT REQUEST DETAILS																								
Request No	SI No	Estimated Request Value	Request Status	Satellite Sensor	Date Of Pass	Row Path No	Product Code	User Priority	User Priority	Quantity	Dispatch Mode	O Orbit Number	Sub Swt Value	Swit Value	Mapsheet No	Mapsheet No	Mapsheet No	Delta Corner	Latitude	Longitude	Area	Band Type	Restart Flag	
1	1	12156.0	POSTED	IIS3	2002-01-01 00000000	097 045	STP00027J			1	COURIER		0	0					00	00				
<p>For Further correspondence and status info please use Order Number and Order Date</p>																								

Figure 6.2.9 Page displaying complete order details



Figure 6.2.10 Page displaying order status

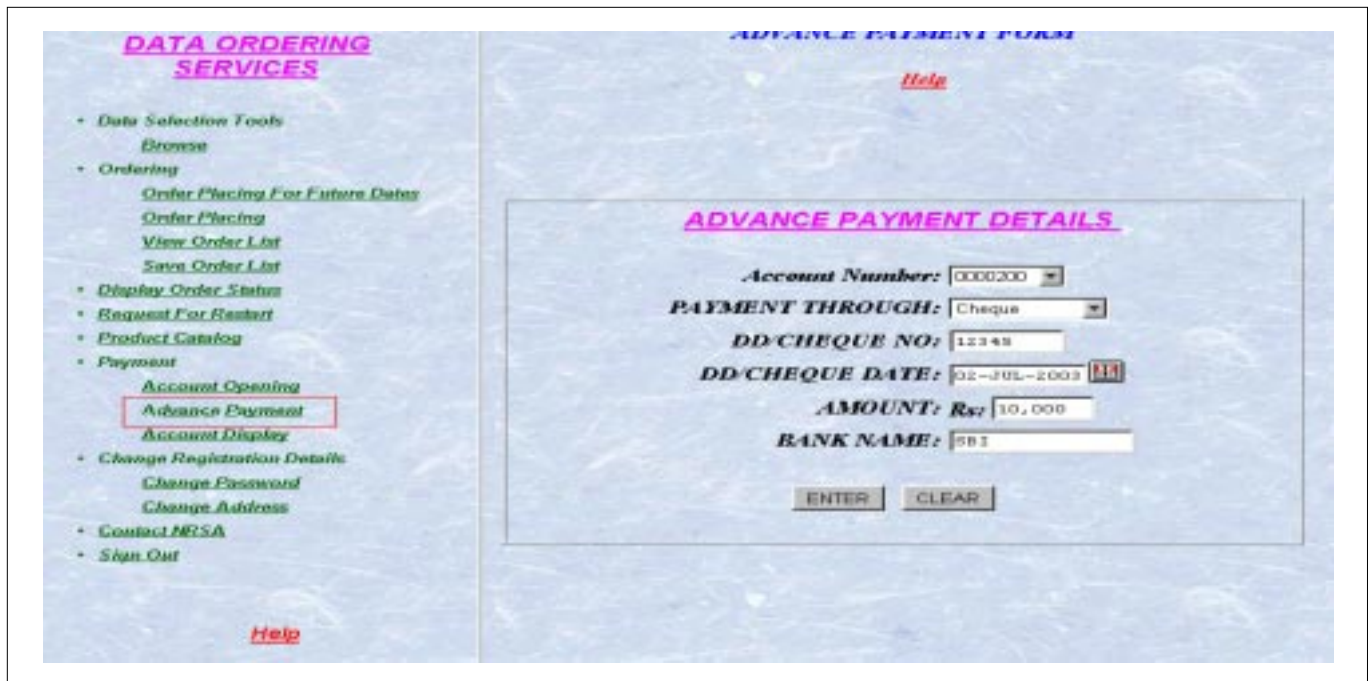

Figure 6.2.11 Advance payment details form

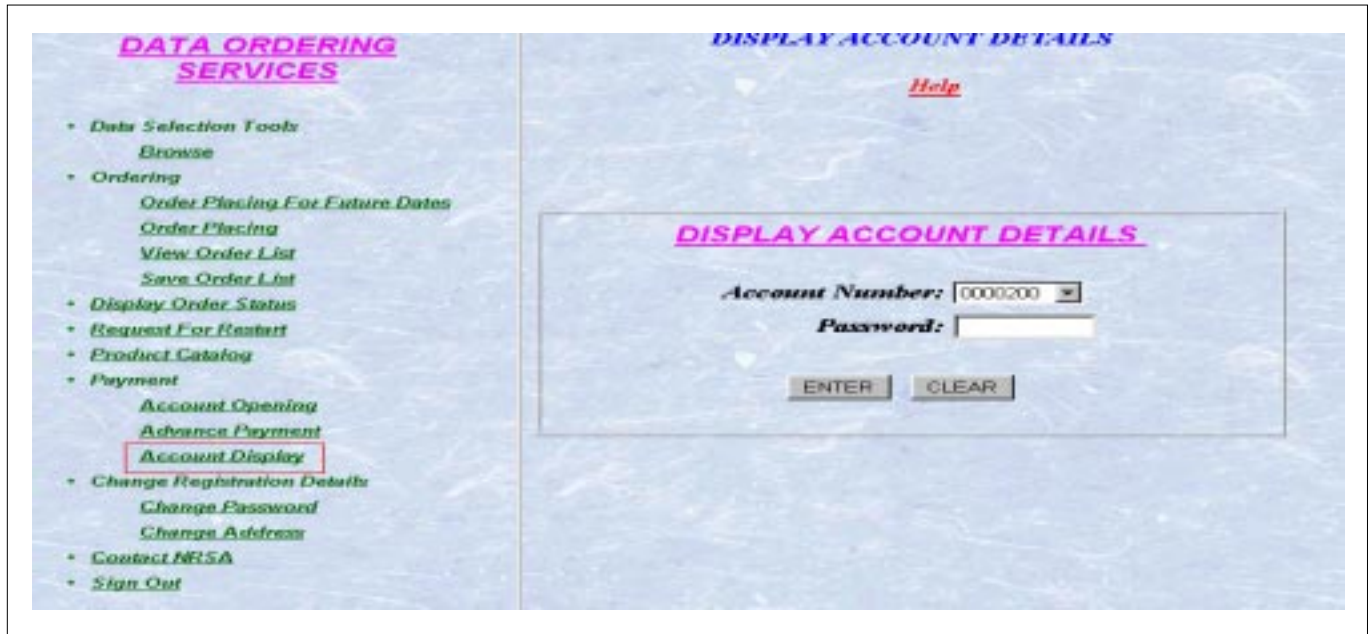

Figure 6.2.12 Page displaying transaction details

As already mentioned, the UOPS is an integrated package for data browsing, ordering through Internet, placing payload programming requests through net. Apart from the above services, the UOPS software has been designed to provide the following off-line services :

6.2.4 Order Processing and monitoring on Intranet by NDC

Order processing facility on Intranet enables NDC to monitor, distribute, process and dispatch the generated products to the customers.

6.2.5 Off-line Order placing by NDC

This system also includes necessary provisions to handle the user requests placed through conventional procedure into the system for further handling at NDC.

6.2.6 Stand Alone Services

In addition, this system handles data archival, account maintenance, report generation and other maintenance procedures required for the routine operations.

6.3 DIGITAL BROWSE FACILITY

6.3.1 Introduction

Before placing an order for data, the users need to browse through the data, to check for cloud and quality of the data. To meet this requirement, NRSA generates sub-sampled and compressed browse images along with necessary ancillary information. This facility is made available to users through Internet. The Browse facility has been integrated with data ordering and payload programming systems. Data can be browsed online and suitable scenes can be selected and converted into a data request by registered users who have an account with NDC.

Users can browse the scenes by submitting any of the following queries (Figure 6.3.1)

1. Search for images based on date of pass
2. Search for images based on path
3. Geographical area based query
4. Map sheet number based query
5. Point identification based query

6.3.2 Search for images based on date of pass

This Query is useful if the User wants to browse the images for a specific date. Users have to choose the satellite, sensor and the date of pass in dd-mmm-yyyy format (Figure 6.3.2). For Example : 12-Apr-1998 (This field is case insensitive). If a wrong value entered, an alert is displayed asking the correct date. When the date field is not entered at all, an alert message asking the date is displayed. However, a

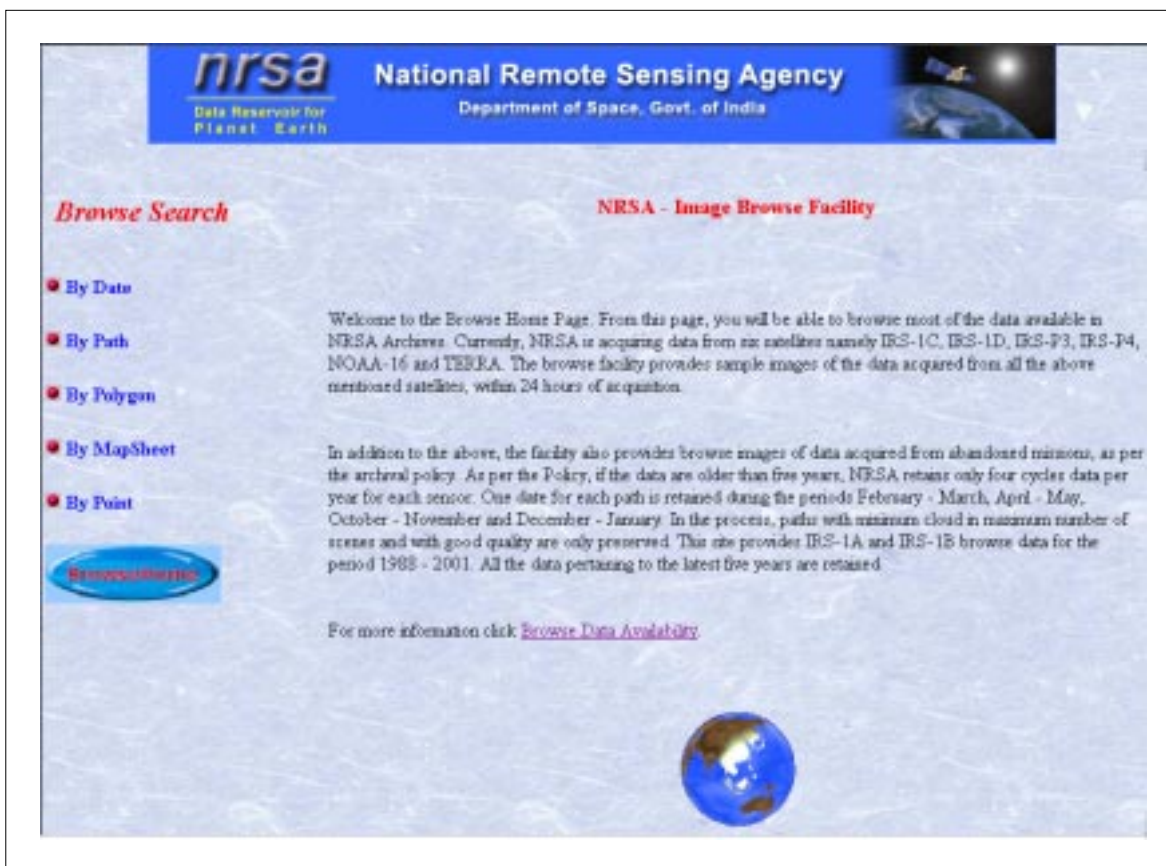

Figure 6.3.1 Browse queries main form

calendar is also provided along the date field for easy operation.

On clicking the path guide, the list of paths acquired for that day, satellite and sensor are displayed. Users have to select the desired path and enter the number of rows for which he would like to browse the scenes and then click submit. While submitting the query if the User opts to see the thumb nail images, small images with meta information are displayed. Otherwise, a page with the list of scenes is displayed. On clicking on the desired scene details, the image along with meta information is displayed. The image

can be viewed with various options like viewing with grid, viewing the scene by shifting by a percent (10 – 90 in steps of 10), view the previous and next scenes.

6.3.3 Search for images based on Path

This Query is useful for viewing the images pertaining to a given path acquired on different dates (Figure 6.3.3). Users have to choose the satellite and sensor, enter path, start row, number of rows and date range (Start-date and End-date) in dd-mmm-yyyy format. For Example : 12-Apr-1998 (This field is case

The screenshot shows a web interface titled "Date Based Query To Browse Archives". It features a search form with the following elements:

- Satellite:** A dropdown menu with "IRS-1D" selected.
- Sensor:** A dropdown menu with "LIS3" selected.
- DateOfPass:** A text input field containing "20-Jul-2003" and a small calendar icon to its right.
- Buttons:** "Check Acquisition Details" and "PathGuide" (highlighted).
- Path No:** A dropdown menu with "081" selected.
- Start Row No:** A text input field with "042".
- End Row No:** A text input field with "058".
- Display Thumb Nails In Results:** A checkbox that is checked.
- Submit/Reset:** Two buttons at the bottom of the form.

Figure 6.3.2 Date base query form

insensitive). On submitting the query, a list of dates on which the desired path and rows have been acquired, are displayed. On selecting a date, details of the scenes are displayed. On selecting the desired scene, the image is displayed which can be viewed with various options. As in the case of date based query, the image can be viewed with various options like viewing with grid, viewing the scene by shifting by a percent (10 – 90 in steps of 10), view the previous and next scenes.

6.3.4 Geographical area based query

This option is useful if the wants to browse the images for a given geographical area (Figure 6.3.4). Users can input their area of interest either in terms of latitude/longitude in degrees, minutes or degrees decimal format of top left and bottom right corners or draw the area on a map with the help of mouse.

On submitting the query, a form requesting the user to enter the period of interest is displayed. Option to

Path Based Query To Browse IRS Archives

[Home](#) [Help](#)

Satellite	<input type="text" value="IRS-1A"/> <input type="text" value="IRS-1B"/>	Sensor	<input type="text" value="LIS1"/> <input type="text" value="LISS3"/> <input type="text" value="PAN"/>
-----------	--	--------	---

Allowed combinations	
IRS1A,IRS1B	LIS1
IRS1C,IRS1D	LIS3,PAN,WIFS
IRSP3	WIFS
IRSP4	OCM
LSAT5	TM
NOA14,NOA16	AVHR

Path No Start Row No No Of Rows

Start Date End Date

Cloud Threshold

Figure 6.3.3 Path based query form

view either the browse images or the accessions, is provided. On submitting, a list of scenes covering the user's area of interest during the desired period, along with a graphical plot is displayed. The user can then, view the images and select.

6.3.5 Map sheet number based Query

Map sheet based geocoded products are one of the most popular products (Figure 6.3.5). So provision to query by map sheet number has been provided to facilitate easy querying by the user. In this case, apart

from satellite, sensor, user has to select the map sheet number, either 15'x 15' or 7 1/2' x 7 1/2'. On submitting the query, a form asking for the desired period is presented. Option to view, either the browse images or the accessions, is provided. On submitting, a list of scenes covering the map sheet, during the desired period, along with a graphical plot, is displayed. The user can then, view the images and select.

The screenshot shows the 'Geographical Area Based Query' interface. At the top, the nrSA logo and 'National Remote Sensing Agency, Department of Space, Govt. of India' are displayed. The main title 'Geographical Area Based Query' is centered in red. A 'Help' link is on the right. Below, there are dropdown menus for 'Satellite' (set to IRS1A) and 'Sensor' (set to LIS1). A 'Lat-Lon Notation' section has radio buttons for 'DECIMAL' (selected) and 'DMS'. The 'Top Left' and 'Bottom Right' sections each have input fields for 'Latitude' and 'Longitude', with dropdown menus for 'North' and 'East' respectively. At the bottom, there are four buttons: 'SUBMIT', 'CLEAR', 'CANCEL', and 'HELP'.

Figure 6.3.4 Geographical area based query form

6.3.6 Point identification based query

6.3.6.1 Latitude-longitude based

This Query takes latitude and longitude of a single point and it maps to a square based on the extent chosen (Figure 6.3.6). This Query is useful if particular area around a point is to be viewed.

User has to select the satellite, sensor, enter Latitude

and Longitude of the point in degrees minutes or degrees decimal format and choose the extent of region desired. The extent of the region can be 50 x 50, 75 x 75, 100 x 100 or 250 x 250 Km. On submitting the query, a form asking for the desired period is presented. Option to view, either the browse images or the accessions, is provided. On submitting, a list of scenes covering the extent with the point as center, during the desired period, along with a graphical plot, is displayed. The user can then,

Figure 6.3.5 Map sheet number based query form

view the images and select.

6.3.6.2 Location name based query

In case the user does not know anything other than the name of the location, he can use this query to browse the images covering the place during the desired period. The inputs to be provided by the user are satellite, sensor and the name of the place. The user is presented with the details of the scene covering his place and on what dates it was covered.

The user can then, view the images and select.

6.3.7 Data ordering

As already mentioned in Section 6.2, the User Order Processing System is an integrated software package which facilitates the users to browse, select, place an order for a desired scene. After browsing the scene and feeling satisfied with the coverage, cloud cover and quality, the user can select the scene, save the details for placing an order for the same.

Figure 6.3.6 Latitude-longitude based query form

6.4 PAYLOAD PROGRAMMING

6.4.1 Introduction

IRS-P6 Payload Programming System (PPS) accepts requests from Users and the several International Ground Stations (IGS) for their future requirements of IRS-P6 data acquisitions.

The satellite acquisition has to be programmed when

- * The LISS-IV camera has to be tilted to acquire an User's Area of Interest (AOI)
- * Stereo imaging is requested
- * There is a requirement for Merged LISS-III/LISS-IV data
- * Data outside the visibility of the Indian ground station is required
- * A ground station requires IRS-P6 data to be transmitted over their station visibility

Quicker revisit/Repeat coverage

The IRS-P6 orbit has a 24-day cycle, which means that LISS-III, LISS-IV and AWiFS data is acquired over the same location every 24 days. LISS-III and AWiFS data over the Shadnagar ground station is collected regularly irrespective of User's request.

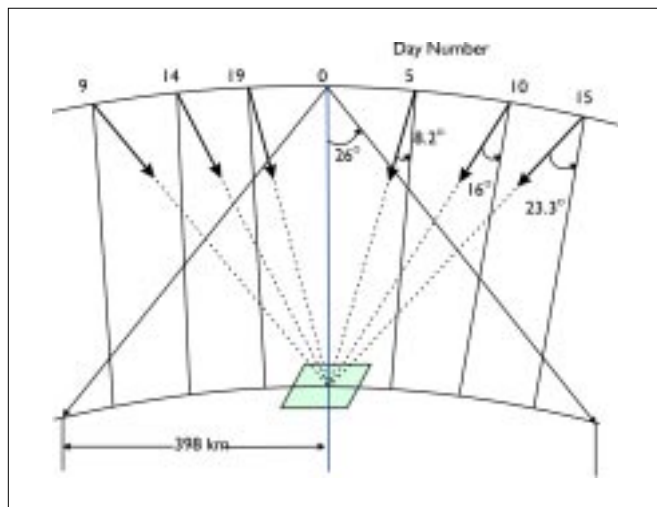

Figure 6.4.1 Steerability of LISS-IV camera

However the LISS-IV camera can be steered unto $\pm 26^\circ$ to provide a more frequent revisit cycle (Figure 6.4.1). This is particularly useful when the application is time-sensitive or when acquiring an image on a specific date is important.

Stereo Imaging

The steerability of the LISS-IV camera offers an opportunity to acquire pairs of images for stereo analysis. To obtain stereo pairs, the same area is viewed from different orbits. Stereo operations are planned in the LISS-IV Mono mode.

Merged LISS-III/LISS-IV data requirement

Acquisitions for requirements for merged data, wherein the high-resolution single band of LISS-IV-Mono is merged with the medium resolution multi-spectral bands of LISS-III sensor, is planned by ensuring that LISS-III and LISS-IV acquire data over the same area on the same day.

On Board Solid State Recorder (OBSSR)

Data over nearly any part of the world can be acquired by the OBSSR. It has a capacity of 120 Gb and can be operated in any of the modes as given in Table-6.4.1. Data requirements outside the visibility of the Shadnagar ground station are programmed using the OBSSR and data recorded are down linked to the Shadnagar station, during night passes. Four minutes is the minimum length of data acquisition (Users need to purchase only what they need).

Ground station Requirements

In the Real-time mode, a ground station can acquire data of any/all of the three sensors viz. LISS-III, LISS-IV and AWiFS by setting to any one of the seven possible modes of real-time acquisitions (Table-6.4.2).

Mode	LISS-3	LISS-4	AWiFS	Maximum duration /pass
1	+	+	+	9 min
2	+	-	+	18 min
3	-	+	-	18 min

Table 6.4.1 Modes of OBSSR acquisition

6.4.2 Programming services

For future date acquisition, the satellite is programmed to collect data with a particular tilt, spectral mode and acquisition mode to service a User request.

Mode	LISS-3	LISS-4*	AWiFS
1	+	+	+
2	+	-	+
3	-	+	+
4	+	+	-
5	+	-	-
6	-	+	-
7	-	-	+

*LISS-4 can be acquired either in Mono/Mx mode.

Table 6.4.2 Modes of real time acquisition

For many applications, the dates on which data is acquired are very important. For example in crop monitoring activities, acquiring data in specific times during crop growth cycle is essential. For such applications, it is advisable to plan data acquisition well in advance. However, if your turn around time is critical, we offer urgent programming, in which case the request is serviced at the earliest possible opportunity. Urgent Programming attracts an acquisition fee.

6.4.3 Programming Activities

Programming requests from Users and ground stations are consolidated at NDC and an optimal acquisition plan for every pass is planned. This plan is arrived at, depending on availability of satellite resources, on the priorities of the requests, and the constraints of the satellite.

- * The acquisition schedule for a week is sent to Spacecraft Control Centre (SCC), ISTRAC at Bangalore.
- * The schedules are refined at SCC with the latest satellite parameters and the necessary commands for the satellite are generated.
- * The schedules are sent to GS and the state vectors are transmitted for acquisition of data.
- * Daily schedules are generated 2 days before the date of pass and can accommodate any urgent requests.
- * After acquisition of the pass, NDC informs the User on the status of acquisition and data is generated on confirmation from the user.
- * After acquisition of the pass, GSs inform NDC and SCC of anomalies if any.

An overall flowchart of the programming activities is shown in Figure 6.4.2 and the timeline of the Programming activities are given in Table 6.4.3

6.4.4 Programming Requests

General Users - Users can place their Programming Requests (PR) online through a web application, which is a sub-system of the User Order Processing System (UOPS), or can send their requests to NDC by Fax or mail which in turn is processed by NDC through UOPS.

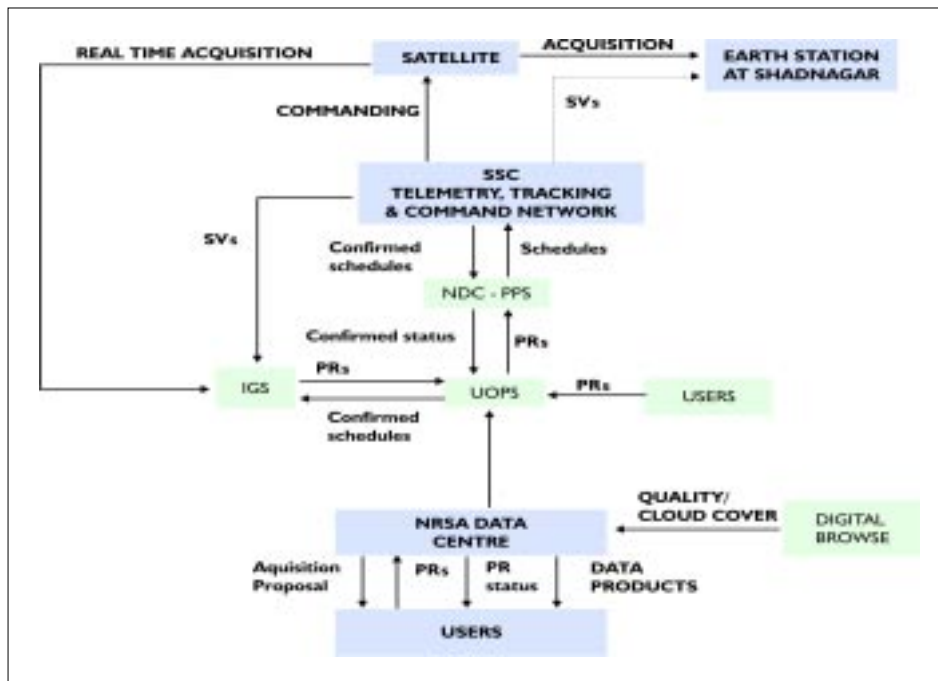

Figure 6.4.2 Overall flow of the programming activities

S No.	Activity	Time frame (days)	From	To
1.	Programming requests from Users	T-15	User	NDC
2.	Acquisition Proposal (on request)	T-13	NDC	User
3.	Confirmed programming request	T-10	User/IGS	NDC
4.	Acquisition plan for a week	T-7	NDC	SCC
5.	Confirmed schedules	T-5	SCC	All Ground Stations
6.	Daily acquisition plan	D-2	NDC	SCC
7.	State vectors	D-1	SCC	All Ground Stations
8.	Pass Performance report(by exception)	D+1	IGS	NDC/SCC
9.	Status of acquisition of user requests	D+1	NDC	User

T is the first day of the target week
D is the date of acquisition
A week is defined from Monday through Sunday

Table 6.4.3 Programming sequence and timeline

Users need to provide the following information while placing a Programming request (PR)

Area of Interest (AOI) - The geographical location of your area can be mentioned in terms of path/row (with the help of the IRS-P6 referencing map)

- * by a set of latitude/longitude co-ordinates (4 points) which bound the area
- * by SOI map sheet number
- * by a place name
- * by a point latitude/longitude co-ordinate.

Period of interest - If data is required on a specific date because of simultaneous ground truth collection or other application requirements, it can be indicated by filling in the same date in the start and end date entries. Otherwise a range of dates can be specified during which data can be acquired.

It may be possible that the satellite may not be available for your request due to already scheduled requests. Advanced placing of request and selecting the appropriate programming service minimise the possibility of conflicts.

Sensors required - The required sensors, LISS-III / LISS-IV or AWiFS have to be specified. In the case of LISS-IV, the spectral mode Mono/Mx has to be additionally specified.

Mode of acquisition - Standard / Stereo/Merged.

Type of service - Depending on the urgency of your requirement you may select between Normal and Urgent programming services.

A typical PR form is shown in Figure 6.4.3.

Before placing a confirmed PR, if the user wants to know the possibilities of acquisitions over the AOI within the period of interest, he can ask for an Acquisition Proposal. An example of an acquisition

proposal is given in Figure 6.4.4.

After the PR form is completed and confirmed, a request number assigned to the request is displayed and status of the request is set to 'Confirmed'. The request takes varying status in the process of getting successfully serviced. Users can check for the status of their request online by keying in the request number. A typical status form is as shown in Figure 6.4.5.

The PRs from various users are carefully studied and priorities are assigned depending on the order in which the PR is received, acquisition mode, type of service etc. Best efforts are made (a maximum of three attempts) to acquire the data over the required area as per user specifications.

After the satellite is programmed, the data is collected in real-time or through OBSSR, as per the request.

If the data is acquired successfully within the user-specified cloud limits and meets quality criteria set forth by NRSA, an acquisition report is sent to the user (online status for the request at this stage indicates 'completed').

The product is generated and despatched to the user. Purchase of data products is mandatory.

International Ground Station request - Ground stations interested in acquiring IRS-P6 data over their station can place their programming requests either through a Nodal ground station or can directly place their requests with NDC.

Nodal ground stations are responsible for the requests of all the ground stations handled by them. If there are any conflicting requests between ground station requests, the nodal ground station resolves conflicts before placing the requests of the ground stations to NDC.

Individual International Ground stations are

DATA ORDERING SERVICES

- Data Selection Tools
 - Graphical Tools
 - Queries
 - Queries
- Ordering
 - Order Placing
 - View Order List
 - View Scenes
 - Save Scenes
- Display Order Status
- Order Placing For Payload Programming
 - [Request Placing](#)
 - [View Proposal](#)
 - [View Request Status](#)
 - [Request Canceling](#)
- Order Placing For Future Dates
 - [Request Placing](#)
 - [View Request Status](#)
 - [Request Canceling](#)
- Payment
 - Account Opening
 - Advance Payment
 - Account Display
- Change Registration Details
 - Change Password
 - Change Address
- Feed Back
- Sign Out

REQUEST PLACING FOR PAYLOAD PROGRAMMING

[Help](#)

Request Form

Satellite: Request Type:

Acquisition Mode: Sensor:

User Priority:

PATH-ROW REQUEST PLACING FORM

[Help](#)

Path-Row Request Form

Path:

Start Row: End Row :

Start Date: End Date:

Figure 6.4.3 Typical PR form

SELECT MEDIA TYPE

[Help](#)

Media Type: PHOTOGRAPHIC

OK CLEAR

Product Order Form

Product Type: STANDARD	Projection: NO PROJECTION
Sampling: NO SAMPLING	Enhancement: NO ENHANCEMENT
Correction Level: RAW	Format: CO -Film
Size: 240mm	Bands: FCC 234
Delivery Mode: COURIER	Ellipsoid: NONE
Quantity: 1	Priority: WITHIN 1 DAY <small>1000 Additional Char</small>

OK CLEAR

DISPLAY PLACED REQUEST

[Help](#)

AcctNo	User-Cat	Satellite	Sensor	ReqType	AcqMode	ReqDate	UserPri	ReqStatus	EstiCost	
0000900	01	IRS-P6	AWIFS	PATH_ROW	STANDARD	17-OCT-2003	NORMAL	1	44000.0	
StartDate	EndDate	Path	StartRow	StartRowId	EndRow	EndRowId	MXStripNo	B_HRatio	MinAccAngle	MaxAccAngle
01-jan-2004	30-mar-2004	200	45		52		0	0.0	0.0	0.0
ProdCode	Ellipsoid	Media-Type	Del-Mode	Quantity	PhotoBandType	PhotoBands				
SILC0027J	NO	D	C	1	ALL	ALL				

[Confirm this Request](#) [Cancel this Request](#)

Figure 6.4.3 Typical PR form (Contd...)

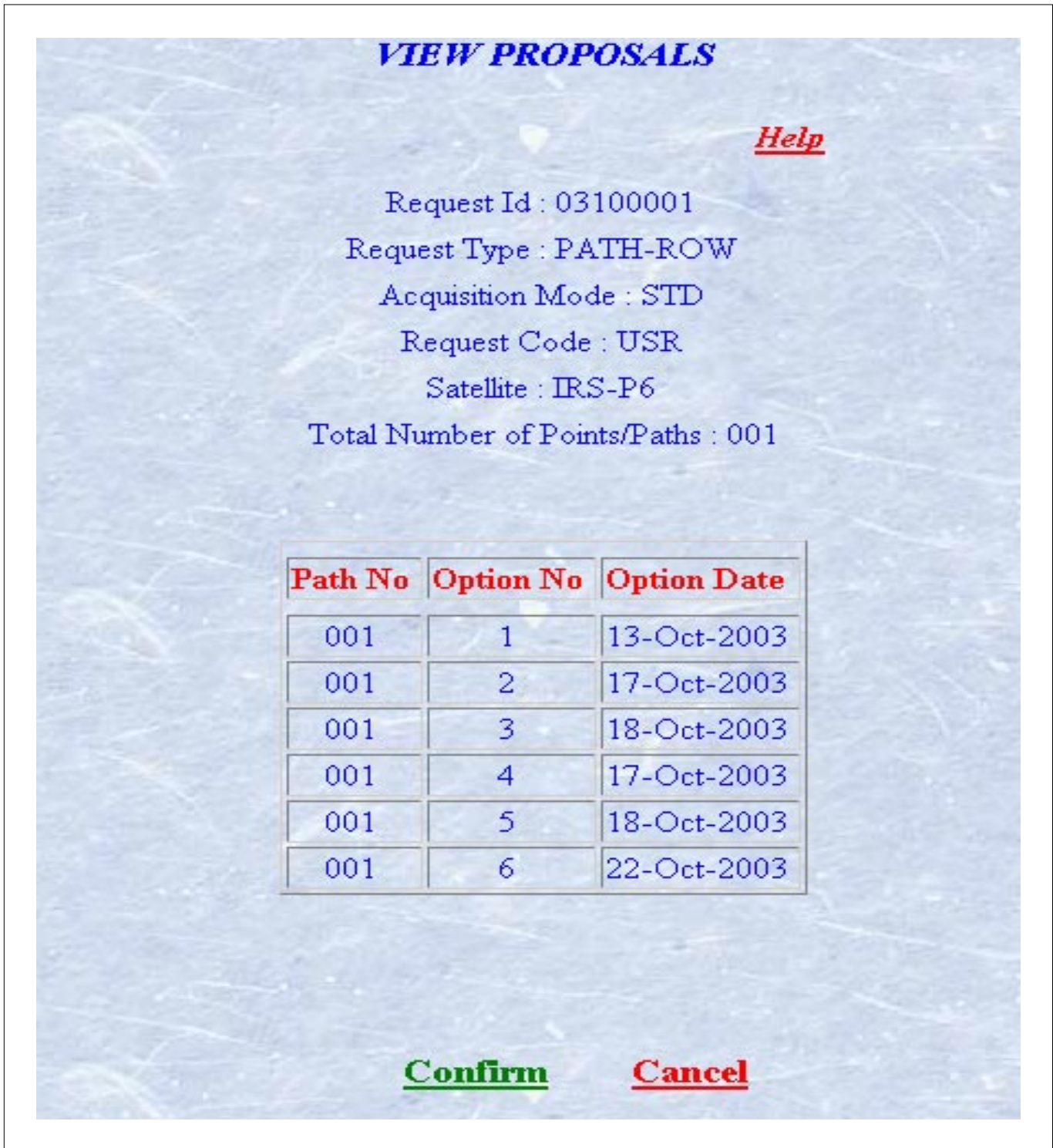

Figure 6.4.4 Acquisition proposal

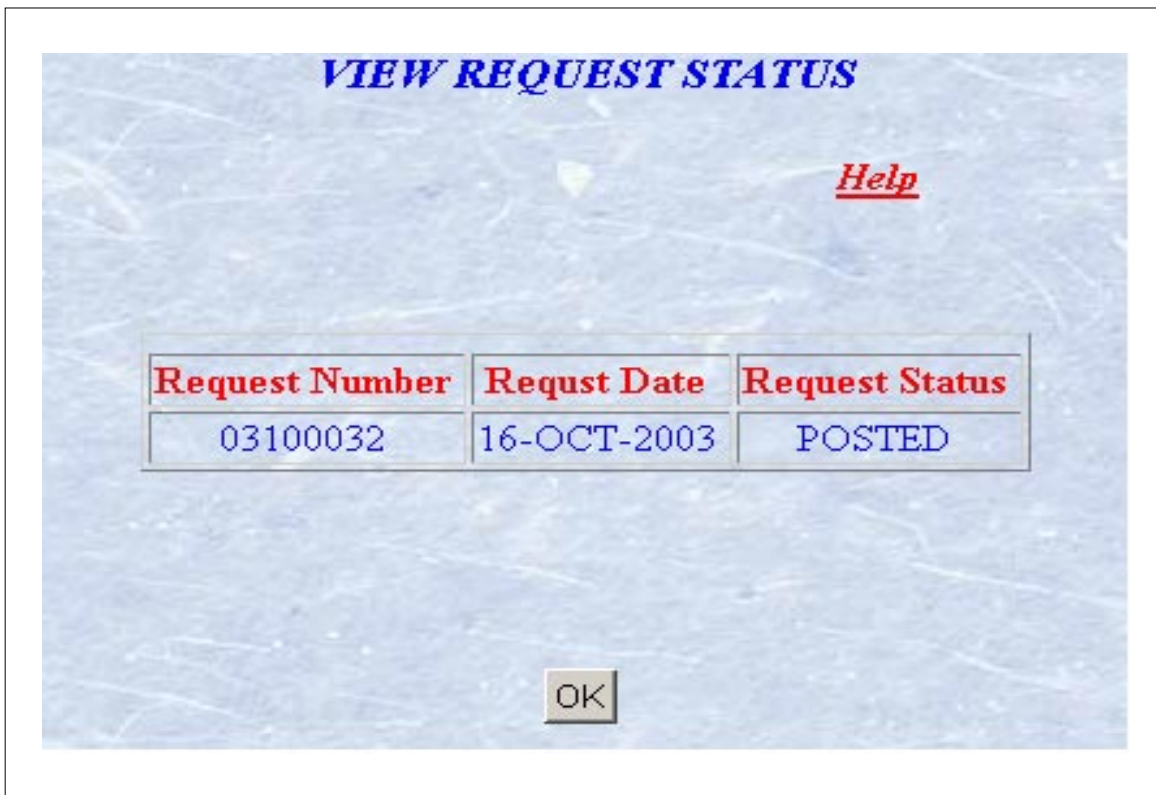

Figure 6.4.5 Typical status form

responsible for the requests planned over their respective ground stations.

All ground stations have to be registered by NDC. NDC provides the User id and password for users to place their requests online. A Ground station can change the password assigned to it.

IGSs need to place, once in a week, programming requests pertaining to a target week (Monday Sunday).

Nodal Ground Stations and other IGSs can use the 'Request placing' option of UOPS to place their programming requests. The Nodal ground station is provided with the list of station codes of the stations handled by them. The PR of each ground station

defines the following parameters for a period of one week

- * Station Id
- * Date of pass
- * Path number
- * Sensor(LISS-III/LISS-IV/AWiFS)
- * Mode (LISS-IV Mono/LISS-IV Mx)
- * Tilt or latitude/longitude of the target
- * Start time and end time of acquisition or start row and end row

The form used by IGSs to place their request is shown in Figure 6.4.6.

The requests are verified for their correctness and the path number requested is validated against the date of pass and the visibility of the ground station.

GS USER SERVICES

- [Request Placing](#)
- [View Schedules](#)
- [Request Cancelling](#)
- [View Request Status](#)
- [View Accounted Acquisition Hours](#)
- [Sign Out](#)

Help

Ground Station User Request Form

User Id: SI Station Name:

ENTER DATE IN dd-mon-yyyy FORMAT

Start Date: End Date:

Satellite: Request Code:

Request Type:

Ground Station User Request Form

Date of pass : 25-Oct-2003

<input checked="" type="checkbox"/> Path Number: 294	Sensor:	<input type="text" value="LIS3+AWIFS"/>
<input checked="" type="checkbox"/> Path Number: 270	Sensor:	<input type="text" value="LIS3+AWIFS"/>
<input checked="" type="checkbox"/> Path Number: 246	Sensor:	<input type="text" value="LIS3+AWIFS"/>

Figure 6.4.6 IGS request form

Each request of a station for a day and Path is assigned a 'Request Number'. The status of the request at this stage is set as 'Posted'.

IGSs can view the status of their requests online.

When a request is programmed, the status changes to 'Serviced'

NDC sends the schedules to the ground station, which indicates all the passes that have been planned for the station with the start and end times of acquisition.

IGSs can cancel a serviced request 2 days before the Date of Pass.

Urgent requests for passes to be planned within five days of acquisition incur an urgent acquisition fee.

State vector information is transmitted by SCC, ISTRAC to the ground stations on a daily basis.

IGSs send the pass performance report within 24 hours after the acquisition of the pass, only on exception, in case of anomalies to SCC and NDC.

6.5 DATA DISSEMINATION

6.5.1 Introduction

NRSA Data Centre distributes IRS data pertaining to the area within the 5 degree coverage of Shadnager earth station to the Indian and foreign users.

Users outside India, but within the 5 degree coverage of Shadnager earth station, may approach NDC. Users outside the coverage of Shadnager earth station, can approach either NRSA or IGSs. Indian users who need the data outside the 5 degree elevation coverage of Shadnager earth station can approach NDC. These products are supplied by programming the satellites for data acquisition using OBSSR.

6.5.2 IRS-P6 data distribution

The various sources of IRS-P6 data world-wide are as follows :

1. Indian users can procure IRS-P6 data products from NDC.
2. International users can get IRS-P6 data products from the following source :

M/s Space Imaging
12076, Grant street
Thorton, Colorado - 80241, U.S.A
e-mail : info@spaceimaging.com
Phone : +1 303 254 2000
Fax : +1 303 254 2217
Web site : www.spaceimaging.com

3. IRS International Ground Stations operating in various parts of the World.

For specific information on availability of an IGS, for a particular location or data of a particular location, users may contact Antrix Corporation Ltd. - the commercial wing of DOS or Space Imaging, U.S.A or the respective IGS.

6.5.3 Data down link access

Antrix Corporation Ltd, Department of Space, is responsible for maintaining and operating IRS-P6 satellite. Space Imaging has the exclusive right to provide down link license and enter into a tripartite agreement with Antrix and the ground station for the down link service.

For data down link access, users can contact Antrix Corporation Ltd. at the address given below or Space Imaging :

Antrix Corporation Ltd.
Antariksh Bhavan, New BEL Road
Bangalore - 560 094,
Karnataka, India
e-mail : info@antrix.com
Phone : +91 80 3416274
+91 80 2172189
Fax : +91 80 3418981
Web site : www.antrix.org

6.5.4 Upgradation / Establishment of Ground Station

Antrix Corporation Ltd. has the required expertise to upgrade the existing ground station having X-band (8 to 8.4 GHz) reception capability to receive IRS-P6 data or set up an entirely new reception and processing facility.

Antrix shall announce from time to time other agencies authorised to provide reception capability for IRS-P6. At present, Space Imaging, U.S.A is in the process of acquiring permission to provide ground stations for IRS-P6 data reception.

6.5.5 Data delivery

The data products are supplied to users either by courier or by speed post. In this mode of data supply, we need to add a minimum of 24 to 48 hours to the Turn Around Time of the data products to reach the

user. Today we have reached a stage where our TAT has improved from one month to few days to few hours of acquisition. We are able to achieve this due to technological advancements in data processing, data handling and possibility of data transfer through the net in near real time.

To expedite data delivery, data needs to be transferred through net. Currently, two modes are operational : Spacenet and ISDN . Data delivery through FTP site is being introduced.

Spacenet

Spacenet is a network for the DOS users only. All the DOS centers are connected through Spacenet and presently we are transferring data to SAC through Spacenet. The band width used for data transfer to SAC is 256Kbps.

ISDN

Any user having ISDN connectivity can approach NDC for the data transfer through net. The ISDN band width at NRSA is 2Mbps. It has a provision of Multi user services with user specific bandwidth. ISDN is a way of establishing high speed connections using regular phone lines.

This is a highly secured way of data transferring as encoding and decoding of the data can be done. In this mode of data delivery, separate directories are created for each user with user specific password and login. As soon as the data is copied on to the directory, the user is intimated about it. In case the volume of data is high, data is made available either band wise or user required area is extracted and put on the user directory.

The user can have an ISDN connection with a Router and Modem on PC based system. The charges are as per the normal telephone charges. There is no failure of network in case of ISDN unless and until the DOT is not down. At the user end the requirement for

ISDN establishments are :

- Remote location router with 2 x ISDN BRI ports
- 2x2 Mb leased line
- 2NT Device supplied by DoT with copper line laid
- PC Server
- 16 Port Switch 10/100 Mbps
- Multiple ISDN closed user group (CUG) support

The flow of the data transfer is shown in the Figure6.5.1

FTP site

In order to make the data available to the users within few hours of acquisition, a web based ftp site is maintained which enables the user to down load the data using his normal Internet connection.

The web site is organized in such a way that it is a part of the NRSA web site with a link to the ftp site. The user is given an account based on user name and

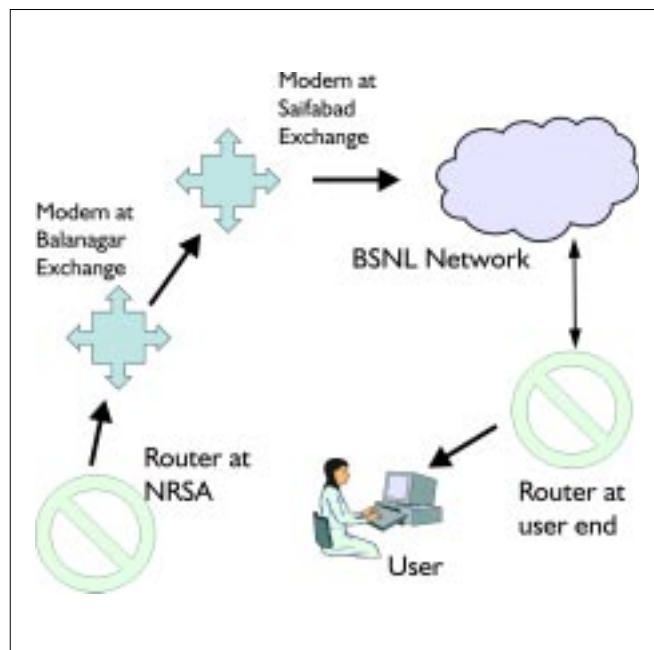

Figure:6.5.1 Flow of data transfer

password. All the users who want to avail this facility should be registered with NDC. The registration is done offline. The users need to write to NDC or mail to NDC for registering themselves. While ordering the data, the user needs to specify whether the data has to be transferred through net or not. In case he needs the data through the net, he needs to mention the mode of transfer i.e., Spacenet or ISDN or Internet. Based on the data requirement the data is generated and copied onto the respective directory of the user. As soon as the data is copied on to the directory the user gets a mail with his password. He needs to key the password while downloading the data.

As the data to be transferred is voluminous, it takes a long time for the transfer. Therefore it has been decided to compress the data and put on the net for the user. Option to select the ratio of compression and the software to be used for compression is given to the user while placing an order for data products supply through net. The level of compression is chosen based on the application and also the level of degradation of the data, acceptable by the user.

7 APPLICATIONS

Introduction

The launch of IRS-1C / 1D satellites with the state-of-art sensors provided a new dimension to the applications of remote sensing data. These satellites were conceived as the “The satellites for all applications”. Further to this, the IRS-P6 payload was designed to provide continued remote sensing data services on an operational basis for integrated land and water resources management. With the enhanced multi-spectral/spatial coverage and stereo imaging capabilities, further studies can be carried out in advanced areas of user applications such as improved crop discrimination, crop yield estimation, forestry and disaster management. In order to have continuity and to support the ongoing projects, the LISS-III camera was included in the payload of IRS-P6, apart from the LISS-IV and AWiFS cameras. The new generation of high spatial resolution satellite data offer the possibility for new cartographic as well as thematic applications. The LISS-IV data with 5.8 m resolution in multi-spectral mode, is helpful in improving the large scale mapping of natural resources and urban areas including infrastructure mapping such as road / rail network. The availability of AWiFS data with improved spatial and spectral resolution will help in better classification accuracy of all agricultural related applications. It is a unique sensor with its high resolution and large swath enables monitoring large areas for flood inundation, vegetation stress etc. The availability of high resolution satellite data enhances the capability of GIS to provide more accurate information on many applications. When the unique advantages offered by IRS-P6 data are translated into application possibilities, in addition to the existing inventories, many more applications can be added up.

Some of the applications of IRS-P6 data are as follows :

Agriculture and soils

Phase level information of soils

- Potential for improved multiple crop discrimination
- Crop monitoring and condition assessment
- Crop canopy water stress
- Crop yield estimates
- Crop management
- Precision farming
- Cropping system analysis
- Damage assessment
- Surveillance of pests and diseases

Forestry

- Inventory and updating
- Forest landscape analysis
- Forest infra-structure mapping
- Forest encroachment
- State of forests
- Wildlife habitat analysis
- Bio-diversity
- Fire damage
- Implementation of forest policies

Environment

- Hydrologic units
- Land unit maps
- Soil contamination maps
- Quarries and waste identification
- Desertification analysis
- Oil spills
- Point and non-point sources of pollution
- Environmental impact assessment

Geology and Exploration

- Rock type mapping
- Tectonic geo- structure mapping
- Mining pollution analysis
- Off/on shore seep analysis
- Coal fire analysis
- Mining subsidence analysis
- Landslide vulnerability / risk
- Geo-energy

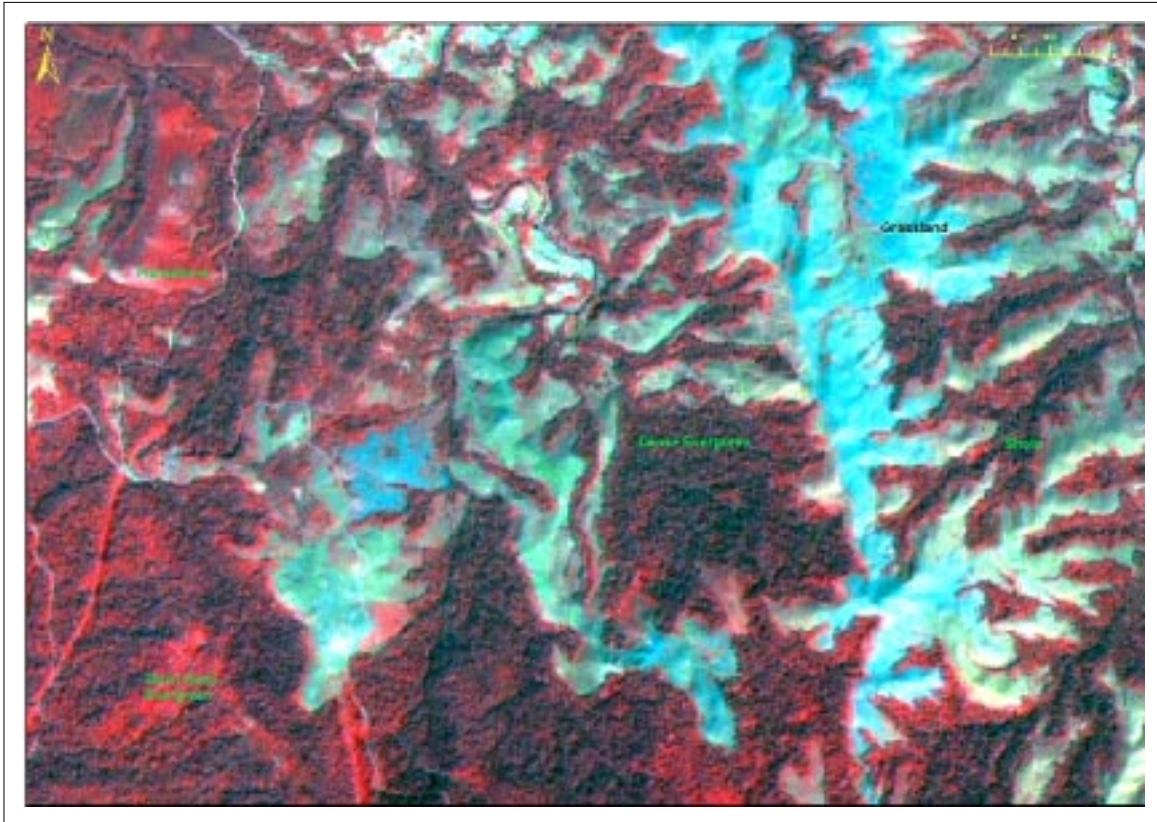

Infrastructure and Utilities

- Road networks
- 3D-city models
- Infrastructure maps
- Siting of hydro-power locations
- Site suitability
- Rural and urban infrastructure
- Structural and hydrological inventory
- Municipal GIS
- Utility corridor mapping
- Transportation network
- Rural road connectivity
- Tracking changes in road
- Telecom facilities
- Recreation Facilities
- Tourism
- Violations
- Damage assessment

Cartography

- Updating topo maps
- Augmenting Databases
- Image maps as base maps
- Watershed management
- Terrain evaluation
- City models
- Road and infrastructure maps
- Site suitability assessment

Defence

- Strategic target monitoring
- Mission planning
- Training
- Treaty verification
- Demining

Some of the applications are discussed in detail with illustrations using IRS-1C/1D data.

I Agriculture

i. Monitoring and forecasting

The 5.8m resolution multi-spectral images are well suited for observing large fields, small-plot, high-value crops. Crop and soil types, moisture content, stress and damage can all be detected using high-resolution satellite imagery. The template registered products of AWiFS enable monitoring of dynamic processes such as crop growth more effectively. The high repetitive coverage of AWiFS enables the timely assessment of crop growth and harvest stages, the effectiveness of irrigation techniques, and fertilizer, pesticide, and herbicide treatments. Crop yields and failures can be more accurately assessed and forecast, as can storm, pest, and drought damage.

ii. Assessment of Farming Practices

Farmers world-wide make substantial annual investments in farm chemicals, yet continue to lose

crop due to pest infestations, plant diseases and poor farming practices. Using high spatial resolution imagery, inadequate irrigation and soil erosion can be identified quickly, while herbicides, pesticides, fertilizers and other agricultural treatments can be more closely monitored and optimized, towards precision agriculture.

II Mapping

i. Image maps

The ability to derive a wide variety of information and to locate features at 1:25,000 scale without ground control, provides an unprecedented opportunity to generate accurate, relatively inexpensive maps for large areas, including inaccessible areas due to terrain. Frequent satellite coverage offered by AWiFS can make such areas easily accessible and inexpensive to update.

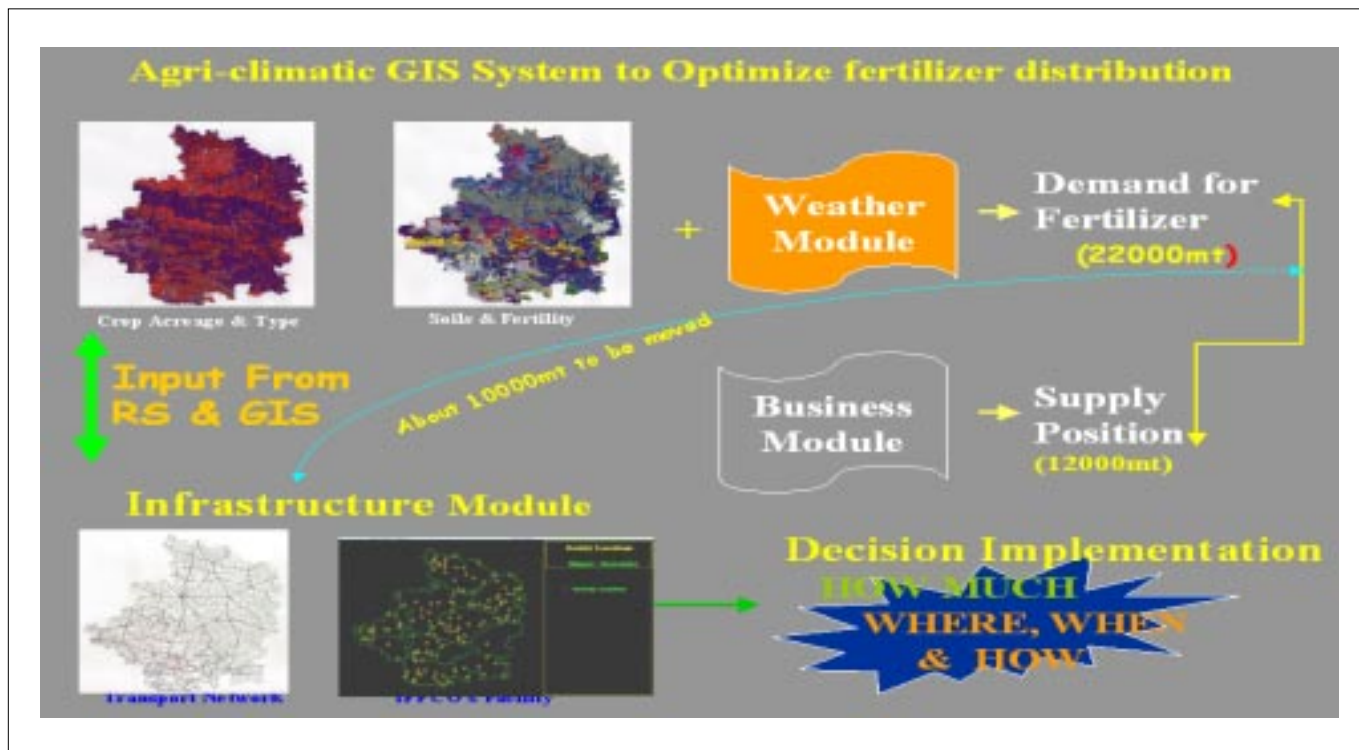

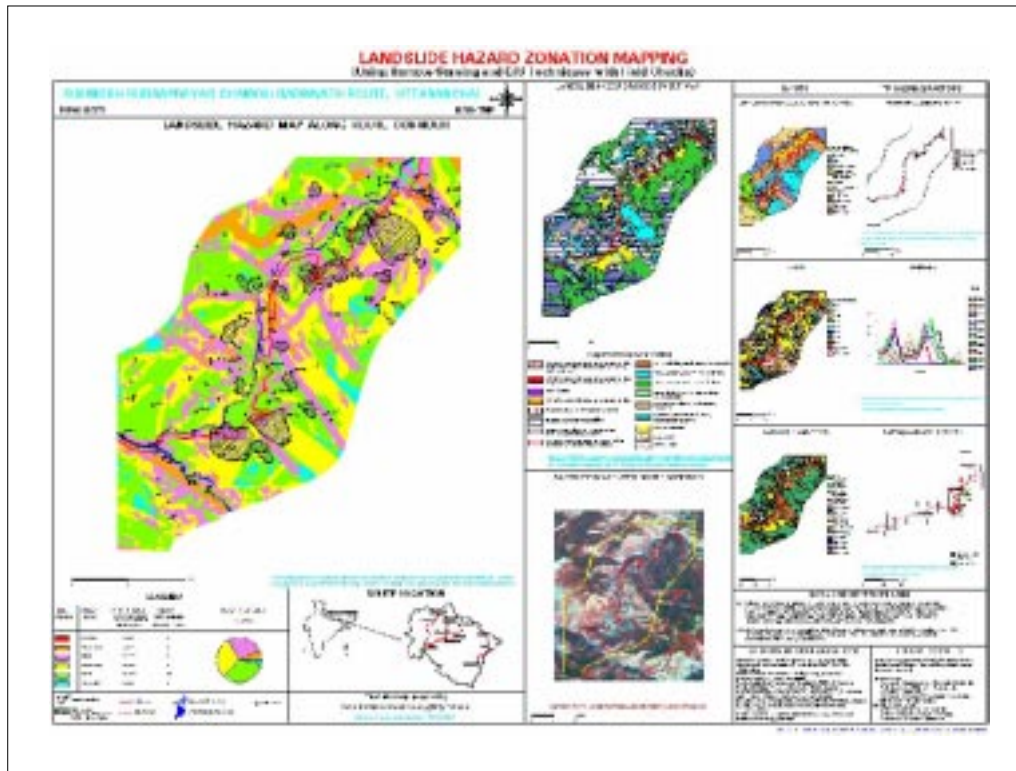

The 5.8m Panchromatic imagery with 70 Km swath provide an alternative for the costly updation of inaccurate medium and small scale maps. The value of satellite imagery is based on the comparison of map and imagery. Infrastructure changes can be quickly detected and updated on maps.

ii. Feature extraction

IRS-P6 high resolution imagery can be used to identify and locate a variety of features, such as street center lines, building footprints, parking lots, and elevation contours to within a few meters horizontal and vertical accuracy.

iii. Infrastructure monitoring

City, regional, and national governments, as well as public and private utilities world-wide, can use high resolution satellite imagery to identify, monitor and

plan for a wide variety of urban and residential infrastructure projects. Streets, highways, bridges, railroads, canals and buildings of all sizes and other infrastructure can be identified and located within a few meters of their true horizontal position.

iv. Utilities and boundaries

Planning, construction, permitting and service activities are more efficient when 5.8 m imagery is combined with vectors and point data to identify parcel boundaries and utility location.

III Environment

i. Hazardous chemical spills

Surface contamination and effects on the surrounding environment can be detected and monitored with high spatial resolution satellite imagery. Routine monitoring of facilities

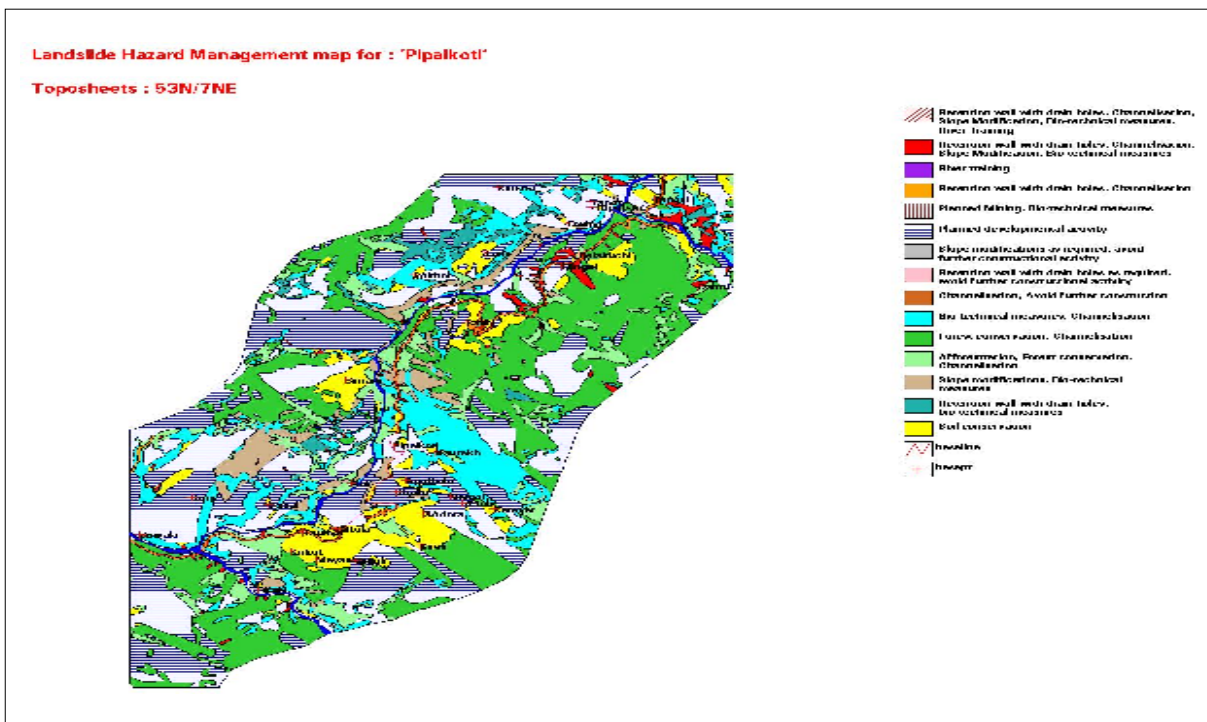
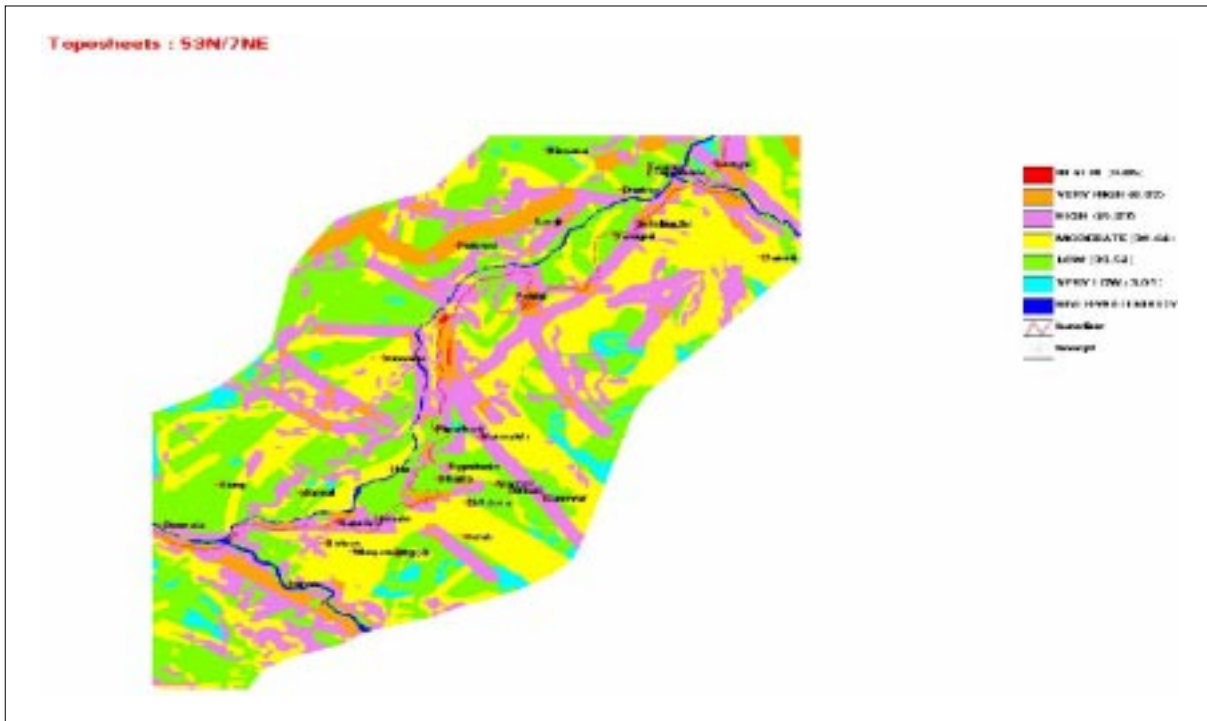

world-wide that handle or store hazardous chemicals and/or waste will be possible. Frequent revisit capability of AWiFS allows early detection of contamination events, such as holding tank failures. The satellite imagery can then be used to assess damage and monitor cleanup and recovery. High resolution multi-spectral imagery are capable of showing the effect of contamination due to failure of holding tank.

ii. Air pollution

Accidental airborne releases of toxic chemicals can be detected and monitored with satellite imagery. For example, if the plume from an oil tank fire is visible to the naked eye, satellite imagery can measure the extent and dissipation of the airborne release as well as pinpoint the source and identify potential areas of impact.

iii. Flood plain management

Flood boundaries can be measured with the help of AWiFS data. Individual buildings and parcel boundaries can also be identified to some extent in order to assess flood vulnerability using the 5.8m multi-spectral data.

iv. Coastal mapping and bathymetry

Detection and monitoring of coral reefs, sea grass beds, mangroves, salt marshes, chlorophyll, sedimentation and development activities are greatly facilitated. Coastal areas can be evaluated for environmental sensitivity and suitability for developing ports, tourist facilities, aquaculture and fisheries.

The best advantages of various sensors on-board IRS-P6 can be realised by applying the most relevant image processing and analytical techniques. E.g., Object oriented approaches will be highly useful in analysing LISS-IV data.

While most of the above mentioned applications have been accomplished using IRS-1C/1D data, the more versatile IRS-P6 data will further enhance such capabilities.

Flood Image of Bihar State

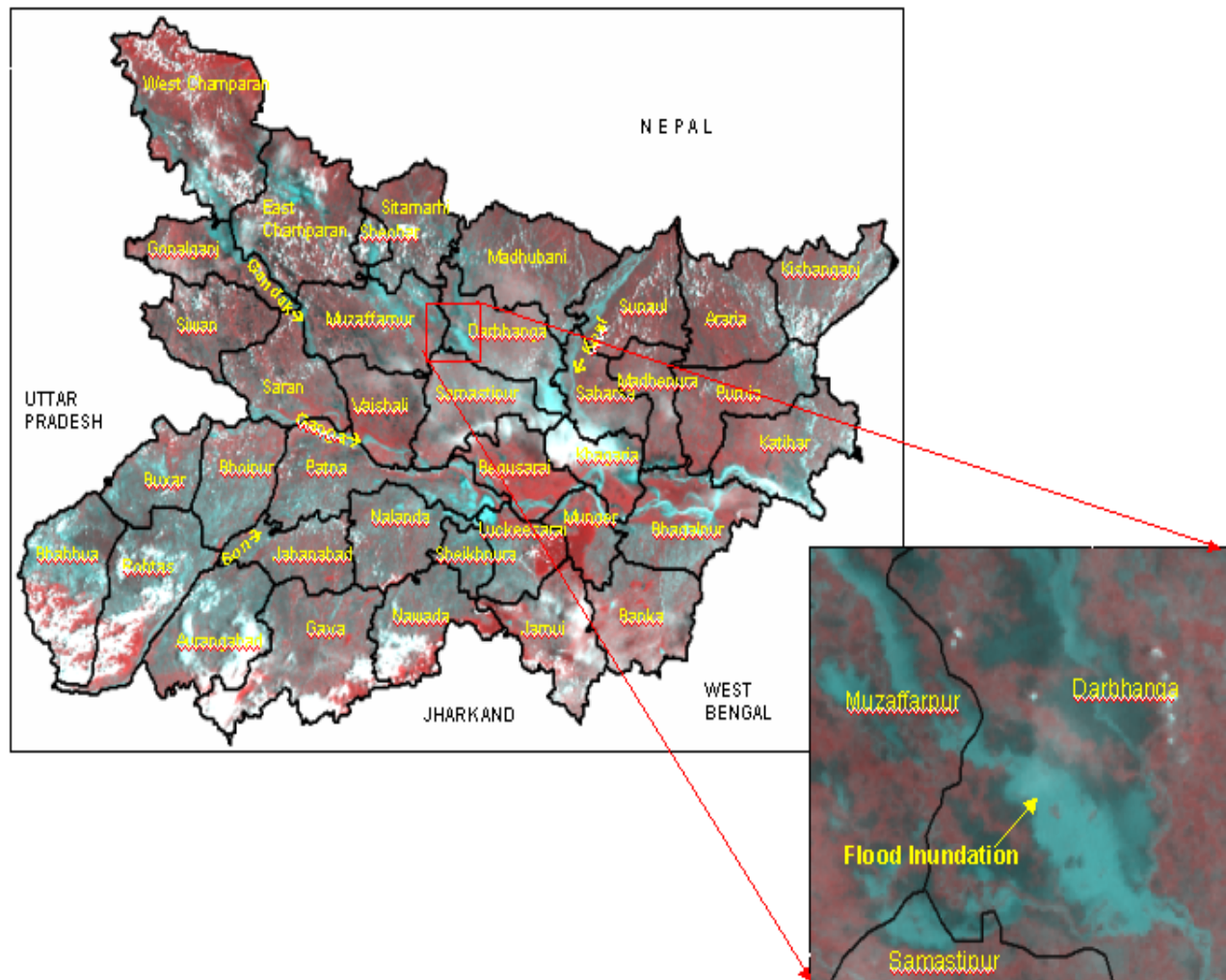

ANNEXURE - I

ACRONYMS

AC	Alternate Current	GCP	Ground Control Point
ADIF	Ancillary Data Information File	GDQE	Geometric Data Quality Evaluation
A/D	Analog to Digital	GPS	Global positioning system
AH	Ampere Hour	G/T	Gain/Noise Temperature
AOCS	Attitude and Orbit Control System	GMT	Greenwich Meridian Time
AOS	Acquisition of Signal	HDT	High Density Tape
AWiFS	Advanced Wide Field Sensor	HDTR	High Density Tape Recorder
BAS	Browse Archival System	HK	House Keeping
BCD	Binary Coded Decimal	HP	Horse Power
BIL	Band Interleaved by Line	Hz	Hertz
BPSK	Bi-Phase Phase Shift Key	IGS	International Ground Station
BSQ	Band SeQential	IMGY	Image data file in UCCT
B/H	Base/Height	IIMS	Integrated Information Management System
B/W	Black & White	IPS	Inches Per Second
CC	Cubic Convolution	IR	Infra-Red
CCD	Charge Coupled Device	IRS	Indian Remote Sensing satellite
CCT	Computer Compatible Tape	ISAC	ISRO Satellite Centre
CFRP	Carbon Fibre Reinforced Plastic	ISRO	Indian Space Research Organisation
DAQLB	Data Archival and Quick Look Browse	IST	Indian Standard Time
DGPS	Differential Global Positioning System	ISTRAC	ISRO Telemetry, Tracking and Command Network
DLT	Digital Linear Tape	JPEG	Joint Photographic Experimental Group
DMCR	Dedicated Mission Control Room	KB	Kilo Bytes
DN	Digital Number	KHz	Kilo Hertz
DOS	Department Of Space	Km	Kilometer
DPGF	Data Products Generation Facility	Lat	Latitude
DPS	Data Processing System	LAN	Local Area Network
DTM	Digital Terrain Model	LBT	Low Bit rate Telemetry
DQE	Data Quality Evaluation	LCC	Lambertian Conformal Conic projection
dB	Decible	LFFR	Large Format Film Recorder
dBm	Decible-milliwatt	LED	Light Emitting Diode
dBw	Decible-watt	LGSO WG	Landsat Ground Station Operators Working Group
deg	Degree	LISS	Linear Imaging an Self Scanning
ECL	Emitter Coupled Logic	LOS	Loss Of Signal
EM	Electro-Magnetic	LSB	Least Significant Bit
EOM	Electro-Optic Module	LTC	Light Transfer Characteristics
EOF	End Of File	LUT	Look-Up Table
EOL	End Of Line	Lon	Longitude
FCC	False Colour Composite	MAR	Mission Analysis Room
FM	Frequency Modulation		
FSKM	Frequency Shift Key Modulation		
FSC	Frame Sync Code		

MCR	Mission Control Room	QC	Quality Control
MB	Mega Bytes	QHS	Query Handling System
MCC	Mission Control Centre	QL	Quick Look
MFPH	Multi-mission Frontend Processing Hardware	QPSK	Quadrature Phase Shift Keying
MHz	Mega Hertz	RAID	Redundant Array of Independent Disks
MOS	Modular Opto-electronic Scanner	RCS	Reaction Control Systems
MSB	Most Significant Bit	RDQE	Radiometric Data Quality Evaluation
MSBR	Multi frequency Scanning Radiometer	RF	Radio Frequency
ms	milli second	RHC	Right Hand Circular
MTF	Modulation Transfer Function	RMS	Root Mean Square
mw	milli watt	RNRZ(L)	Randomised Non-Return to Zero (level)
Mx	Multi-spectral	RNRZ(S)	Randomised Non-Return to Zero
N	Newton	RPM	Rotations Per minute
ND	Neutral Density	RRSSC	Regional Remote Sensing Service Centre
NB	Narrow Band	RSS	Root Sum Square
NDC	NRSA Data Centre	RST	Raw Star Sensor
NIR	Near Infra Red	SAC	Space Application Centre
NN	Nearest Neighbour	SAT	Shift Along the Track
NNRMS	National Natural Resources Management System	S/c	Spacecraft
NRSA	National Remote Sensing Agency	SCC	Spacecraft Control Centre
OBTR	On-Board Tape Recorder	SCR	Silicon Controlled Rectifier
OCM	Ocean Colour Monitor	SI-EOSAT	Space Imaging-Earth Observation Satellite Company
OSR	Optical Solar Reflectors	SNR	Signal to Noise Ratio
PC	Personal Computer	SPS	Satellite positioning System
PCT	Photo Compatible Tape	SOM	Space Oblique Mercator
PCM	Pulse Code Modulation	SOI	Survey of India
PM	Phase Modulation	SWIR	Short Wave Infra Red
Pol	Polyconic	SWR	Square Wave Response
PPS	Payload Programming System	TC	Tele Command
PR	Programming Request	TCG	Time Code Generator
PS	Polar Stereographic	TCT	Time Code Translator
PSLV	Polar Satellite Launch Vehicle	TRAI	Trailer file in UCCT
PSK	Phase Shift Key	TIU	Telemetry interface unit
PSM	Payload Steering Mechanism	TTC	Telemetry, Tracking and Command
QAS	Quality Assurance Scheme	TWTA	Travelling Wave Tube Amplifier
		UT	Universal Time
		UTM	Universal Transverse Mercator